

Circulating Fluid Temperature Controller Refrigerated Thermo-cooler Series *HRG*

Makes cooling water easily available, anytime, anywhere.

○ Cooling capacity (60 Hz):

1.1 kW / 2.3 kW / 4.8 kW, 9.5 kW / 14.5 kW
(Air-cooled refrigeration)

1.1 kW / 2.3 kW / 4.8 kW, 11.0 kW / 16.5 kW
(Water-cooled refrigeration)

○ Temperature stability: $\pm 1^{\circ}\text{C}$ (Refrigerator ON/OFF control) / $\pm 0.5^{\circ}\text{C}$ (Proportional valve PID control)

○ Temperature range setting: **5 to 35** $^{\circ}\text{C}$



Application Examples

Temperature control of LCD panels

Example: Cooling an LCD panel

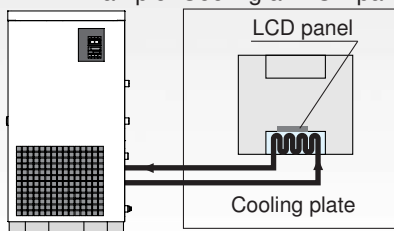

Can be used for cooling during transfer to processing, before and after resist coating and firing of the glass substrate.

Temperature control of welding torches

Example: Laser welding

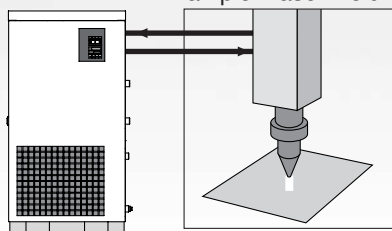

Can be used to supply cooling water to welding torches or commercially available laser welding devices, and to prevent overheating of the torch or the oscillation tube.

As a replacement for a cooling tower

Air-cooled refrigeration HRG

With casters (Option)

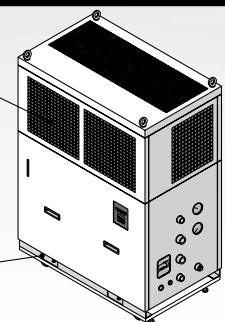

Installing extra cooling towers can be troublesome. The HRG series (air-cooled refrigeration) can be moved easily to wherever you need it, when you need it. Cooling water is supplied from the attached hose.

Energy Saving

● Power consumption: Max. 70% reduction

When the circulating fluid reaches a certain preset temperature, the refrigerator stops temporarily (idling stop) and the temperature is adjusted (refrigerator ON/OFF control). Stopping the refrigerator for longer periods of time and operating at low load (idling mode) reduces power consumption dramatically. Even in processes where there is heat loading, performance is at least as good as that of inverter control.

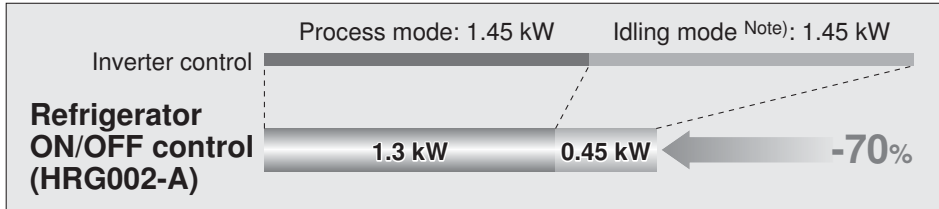

Note) Operating conditions: Process mode: Circulating fluid temperature 20°C, Heat load 2 kW
 Idling mode: Circulating fluid temperature 20°C, Heat load 0 kW

- Reduced running cost
- Contribution to the environmental preservation

● Refrigerant: Max. 50% reduction (SMC comparison)

Conventionally, reducing the amount of refrigerant gas has meant a reduction in cooling performance. Now, however, the HRG's use of an improved high-performance **heat exchanger** Note) makes it possible to reduce the volume of refrigerant used (refrigerant charge volume) without sacrificing cooling performance.

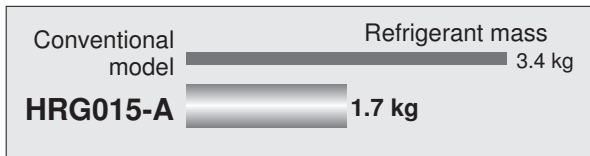

Note) HRG010-A, HRG015-A only

- More environmentally friendly

● Efficiency: 42% improvement (SMC comparison)

A new high-performance **heat exchanger** Note) improves the HRG heat exchange capability, delivering greater efficiency (= cooling capacity / power consumption).

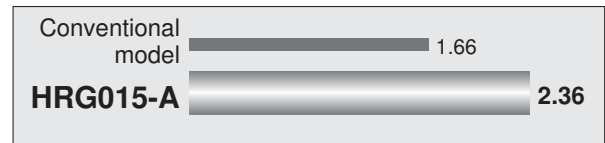

Note) HRG010-A, HRG015-A only

- Reduced running cost
- More environmentally friendly

High Performance

● Temperature stability: $\pm 0.5^{\circ}\text{C}$ Note 1) 3) $\pm 1.0^{\circ}\text{C}$ Note 2) 3) (when a load is stable)

Two types of temperature control are provided: to $\pm 0.5^{\circ}\text{C}$ specifications using split flow from a three-way proportional valve, and simple temperature control to $\pm 1.0^{\circ}\text{C}$ specifications using the refrigerator ON/OFF mechanism. Choose the temperature stability that is right for your manufacturing process and method.

■ $\pm 0.5^{\circ}\text{C}$ type (HRG002-A5)

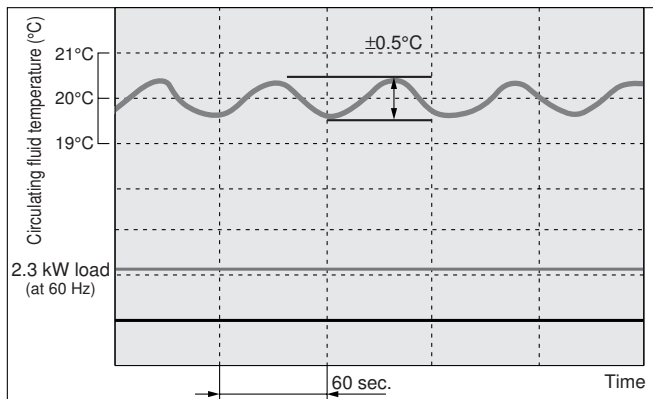

Note 1) HRG001-□5 to HRG005-□5

Note 3) The value shown applies to a stable load state with no outside interference. Actual values may vary depending on the operating conditions.

■ $\pm 1.0^{\circ}\text{C}$ type (HRG002-A)

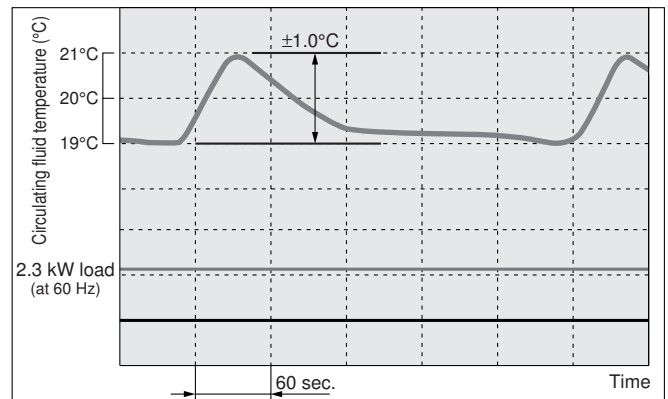

Note 2) HRG001-□ to HRG015-□

Space Saving

● External volume: Max. **35%** reduction (SMC comparison)

Mass: **23%** reduction (SMC comparison)

Footprint: Max. **12%** reduction (SMC comparison)

Improvements in the HRG's high-performance **heat exchanger** have enabled the size of the unit to be reduced, with corresponding reductions in mass and space needed for installation.

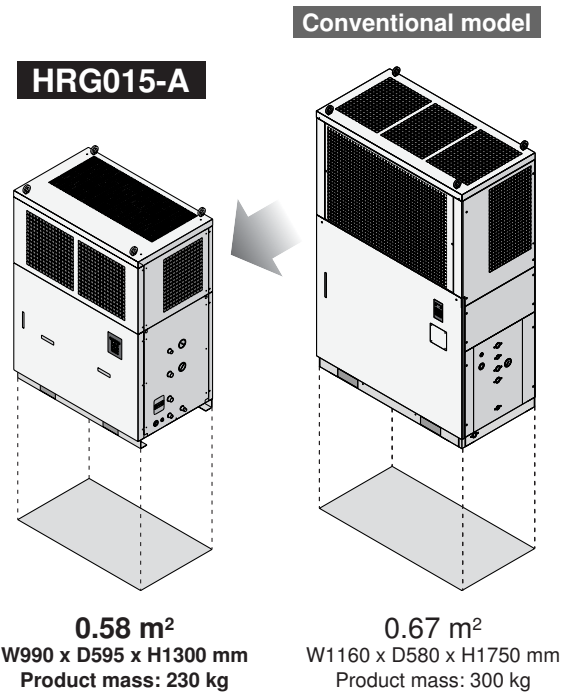
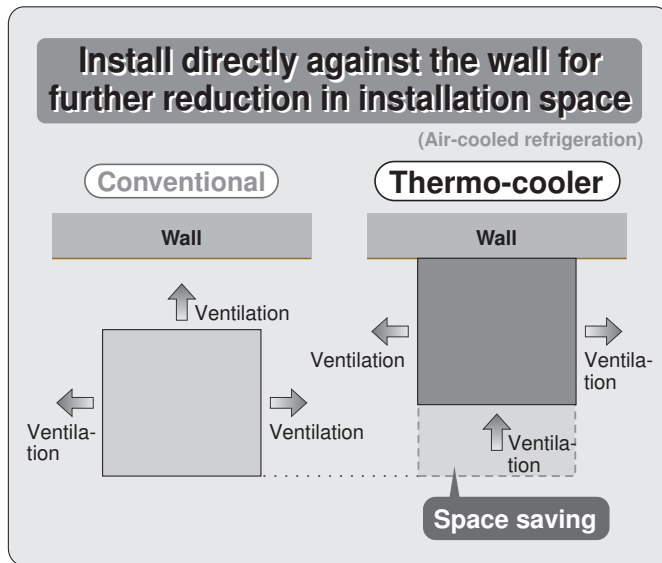

● Cooling capacity:
Max. **16.5 kW** ^{Note)}

A maximum cooling capacity of 16.5 kW has been achieved with our air-cooled and water-cooled refrigeration ranges.

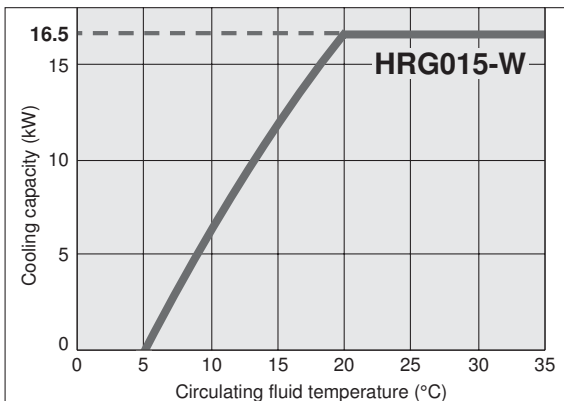

Note) HRG015-W operating at a power supply frequency of 60 Hz

● Wetted parts adopt the materials compatible for various circulating fluids.

- Aqueous solution of 15% ethylene glycol
- Clear water, Deionized water ^{Note)}

Note) Supply with water of electrical conductivity 1 μS/cm or more. Please note that it is not possible to maintain a specific electrical conductivity.

- HRG
- HRGC
- HRZ
- HRW
- HEC
- HEB
- HED
- Technical Data
- Related Products

Easy Operation and Maintenance

Simple operation

(Standard specifications)

Operation ①

Press the ON button.

Operation ②

Adjust the temperature setting with the UP/DOWN keys.

Operation ③

Press the OFF button to shut down.

What could be easier?!

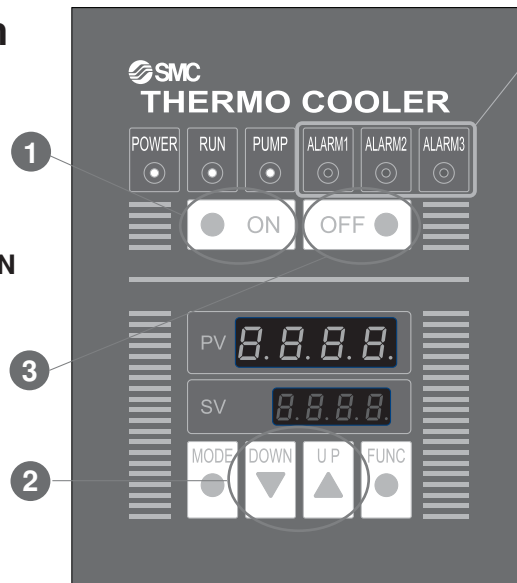

With individual alarm indicators

Three separate levels of alarm indicators ^{Note)} for easy failure diagnosis. (Supplied as standard for the HRG010-□ and HRG015-□, and as specials for the HRG001 to HRG005.)

Individual red LED alarm indicators

ALARM1 Abnormal installation status

ALARM2 Water delivery circuit error

ALARM3 Refrigeration circuit error

Note) Refer to page 24 for operation display panel and alarms.

Contact input/output signal

(Standard specifications)

Remote operation signal input

Startup and shutdown can be remotely controlled by applying 24 VDC.

Operation, shutdown, alarm signal output

Operation, shutdown, alarm signal can be output via the relay contact.

Easy maintenance

(Standard specifications)

Components can be accessed from the front. The pump, refrigerator thermal relay and reset switch (for use in the case of problems with facility water supply) are located inside the electrical component enclosure.

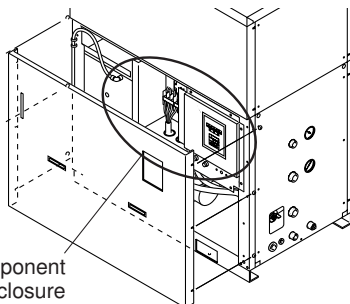

Electrical component enclosure

Options

Various options are available, including with casters, circuit breakers and communications function. Specify options according to your particular manufacturing process and method.

(Refer to pages 26 and 27 for options.)

Optional accessories

Dustproof filters for the by-pass piping set and air-cooled refrigeration are available.

These improve durability and ease of use.

(Refer to pages 28 through to 35 for optional accessories.)

Air-Cooled Refrigeration

Air-cooled refrigeration

Unlike the water-cooled refrigeration, the air-cooled refrigeration does not require a facility water, and is easy to install alongside your equipment.

Rainproof design: Enclosure IPx3

In addition to the previously available indoor installation specifications, we now offer specifications for outdoor installation. ^{Note)}

Note) HRG010-□, HRG015-□

Communications

Communications function (RS-485)

(Refer to page 27 for options.)

Contact input/output function

(Refer to page 25.)

Application Examples

Semiconductor

Example: Temperature control of a chamber electrode

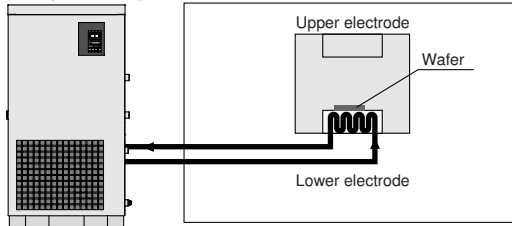

- Etching equipment
- Coating equipment
- Spatter equipment
- Dicing equipment
- Cleaning equipment
- Tester, etc.

Medical

Example: Blood preservation

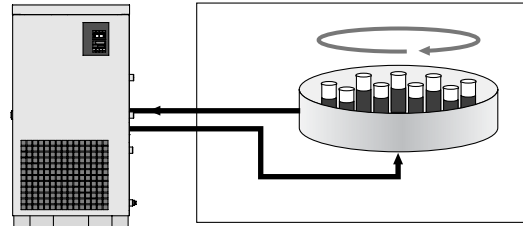

- X-ray instrument
- MRI
- Blood preservation equipment

Food

Example: Tofu (Bean curd) production

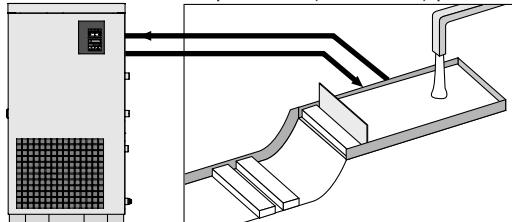

- Bottle-cleaning machine
- Tofu (Bean curd) production equipment
- Noodle-making machine, etc.

Water temperature control for forming tofu by mixing the boiled soybean milk and bittern.

Analysis

Example: Electronic microscope

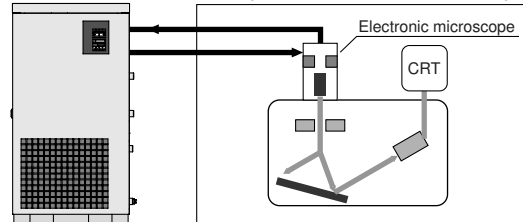

- Electron microscope
- X-ray analytical instrument
- Gas chromatography
- Sugar level analytical instrument, etc.

Prevents the distortion caused by the heat generated by the electronic gun in an electronic microscope.

Machine tool

Example: Laser machining

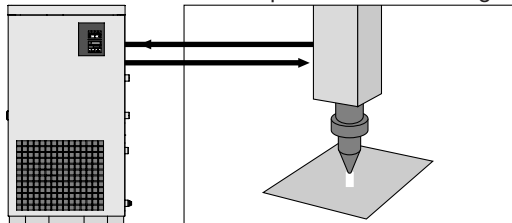

- Wire cutting
- Grinder
- Spot welding
- Plasma welding
- Laser machining, etc.

Temperature-controlling the laser generating tube enables the laser wavelength to be optimised, improving the accuracy of the machined cross sectional area.

Printing

Example: Printing temperature control

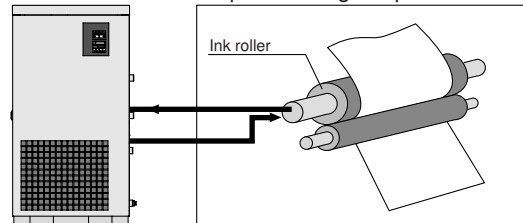

- Offset printing machine
- Automatic developing machine
- UV equipment, etc.

Temperature-controlling the ink roller enables to control the evaporation amount and viscosity of an ink and optimise the tint of colors.

Molding

Example: Injection molding

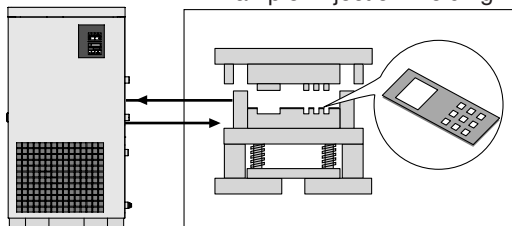

- Plastic molding
- Rubber molding
- Wire cable coating machine
- Injection molding, etc.

Temperature-controlling the mold results in improved product quality.

HRG

HRGC

HRZ

HRW

HEC

HEB

HED

Technical Data

Related Products

Construction and Principles

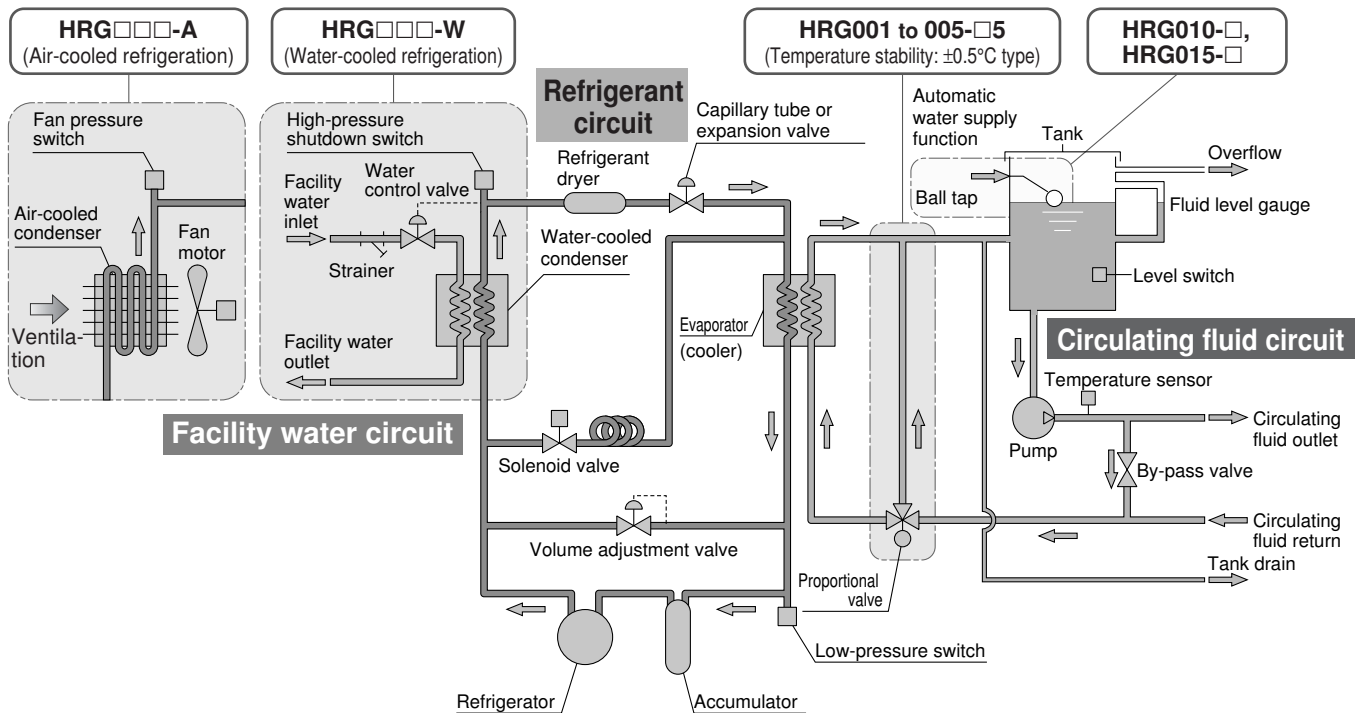

Circulating fluid circuit

With the circulating pump, circulating fluid will be discharged to the customer's equipment side. After the circulating fluid will cool the customer's equipment side, it will heat up and return to the Thermo-cooler.

■ Temperature stability: ±0.5°C type (HRG001 to 005-□5)

If the temperature of the circulating fluid is higher than the preset temperature, the three-way proportional valve will return the circulating fluid to the cooler. If the temperature of the circulating fluid is lower than the preset temperature, the fluid will be returned directly to the tank.

When the temperature of the circulating fluid is nearly the same as the preset temperature, the temperature will be stabilized by split flow between the cooler and the tank.

Refrigerant circuit

High-temperature, high-pressure freon gas compressed by the refrigerator is made to release heat by the condenser, and turns to liquid. As the liquefied high-pressure freon passes through the capillary tube and expansion valve, it expands and cools down; as it passes through the evaporator, heat is extracted from the circulating fluid and it evaporates.

The evaporated freon is once again sucked in and compressed by the refrigerator, and the above cycle is repeated.

When the circulating fluid is cooled sufficiently, the solenoid valve and volume adjustment valve open. These valves balance the refrigerant pressure and prevent freezing of the circulating fluid (especially clear water) in excessively cold conditions.

■ Temperature stability: ±1.0°C type (HRG□□□-□□)

If the temperature of the circulating fluid is higher than the preset temperature, the refrigerator starts up, and freon gas flows to the evaporator (cooler). This cools the circulating fluid. If the temperature of the circulating fluid is lower than the preset temperature, the refrigerator shuts down, and the flow of freon gas stops. At such times, the circulating fluid is not cooled, and the temperature rises.

Temperature stability is achieved by the refrigerator starting up and shutting down.

Facility water circuit

■ Cooling method: Water-cooled refrigeration (HRG□□□-W)

When the freon gas is adequately liquefied and the circulating fluid is adequately cooled, the water control valve automatically closes the facility water circuit and adjusts the flow of facility water.

This method assures normal pressure in the refrigerator and reduces energy use by your facility water equipment.

CONTENTS

Series HRG

Model Selection	
• Guide to Model Selection	P. 8, 9
• Calculation of Required Cooling Capacity	P. 10 to 12
• Precautions on Model Selection	P. 13
• Circulating Fluid Typical Physical Property Values	P. 13
● Basic Model	
How to Order / Specifications	P. 14, 15
Cooling Capacity / Pump Capacity / Facility Water Required Flow Rate	P. 16, 17
Dimensions	P. 18 to 21
Piping Connection and Installation Dimensions	P. 22, 23
Operation Panel Display	P. 24
Alarm	P. 24
Contact Input/Output Function	P. 25
Other Features	P. 25
● Options	
With Casters	P. 26
With Ground Fault Circuit Interrupter	P. 26
With Communications Function (RS-485)	P. 27
● Optional Accessories	
Specifications / How to Order	P. 28, 29
Dimensions	P. 30 to 33
Mounting Example	P. 34, 35
Specific Product Precautions	P. 36 to 40

HRG

HRGC

HRZ

HRW

HEC

HEB

HED

Technical Data

Related Products

Series HRG Model Selection

Guide to Model Selection

1. Which is best for you: a water-cooled refrigeration or an air-cooled refrigeration?

You should base your choice on the configuration of your equipment.

Thermo-cooler series refrigeration methods

Water-cooled refrigeration Requires facility water equipment (cooling tower etc.) as well as electrical power supply. This type provides stable cooling performance year round, regardless of ambient temperature changes.

Air-cooled refrigeration Only electrical power supply is needed.
Facility water equipment is not necessary, so the system is easy to install wherever you need it, when you need it. Please note that ventilation or air conditioning is required to dissipate heat: for details, refer to page 36. Operating Environment / Storage Environment 3 on Specific Product Precautions 1.

Example) Customer requirement: Air-cooled refrigeration

2. How much is the temperature in degrees centigrade for the circulating fluid?

Temperature range which can be set with the Thermo-cooler

5°C to 35°C

Example) Customer requirement: 20°C

3. What kind of the circulating fluids will be used?

Relationship between circulating fluid (which can be used with the Thermo-cooler) and ambient temperature

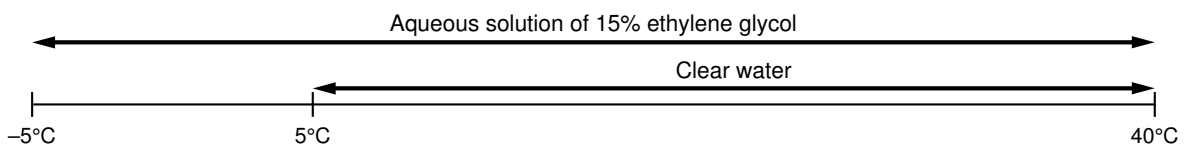

Example) Customer requirement: Clear water

4. What power supply frequency?

Thermo-cooler power supply frequency specifications

50 Hz, 60 Hz (common use)

Example) Customer requirement: 60 Hz

5. What is the kW for the required cooling capacity?

* To calculate the cooling capacity, refer to pages 10 to 12.

Example) Customer requirement: 4.2 kW (Refer to example 1 (1).)

Selection

Example: Customer requirements 1 to 5

Cooling method : Air-cooled refrigeration
 Circulating fluid temperature: 20°C
 Fluid : Clear water
 Power supply frequency : 60 Hz
 Required cooling capacity : 4.2 kW

Based on the results of 1 to 5, refer to the graph of cooling capacity of an air-cooled refrigeration Thermo-cooler at 60 Hz (page 16). On the same graph, plot the intersections between the customer's required temperature (20°C) and cooling capacity (4.2 kW). Refer to the same graph that can be used for ethylene glycol aqueous solution (15% or less.)

[Cooling Capacity Graph] Cooling Method: Air-Cooled Refrigeration, Power Supply Frequency: 60 Hz

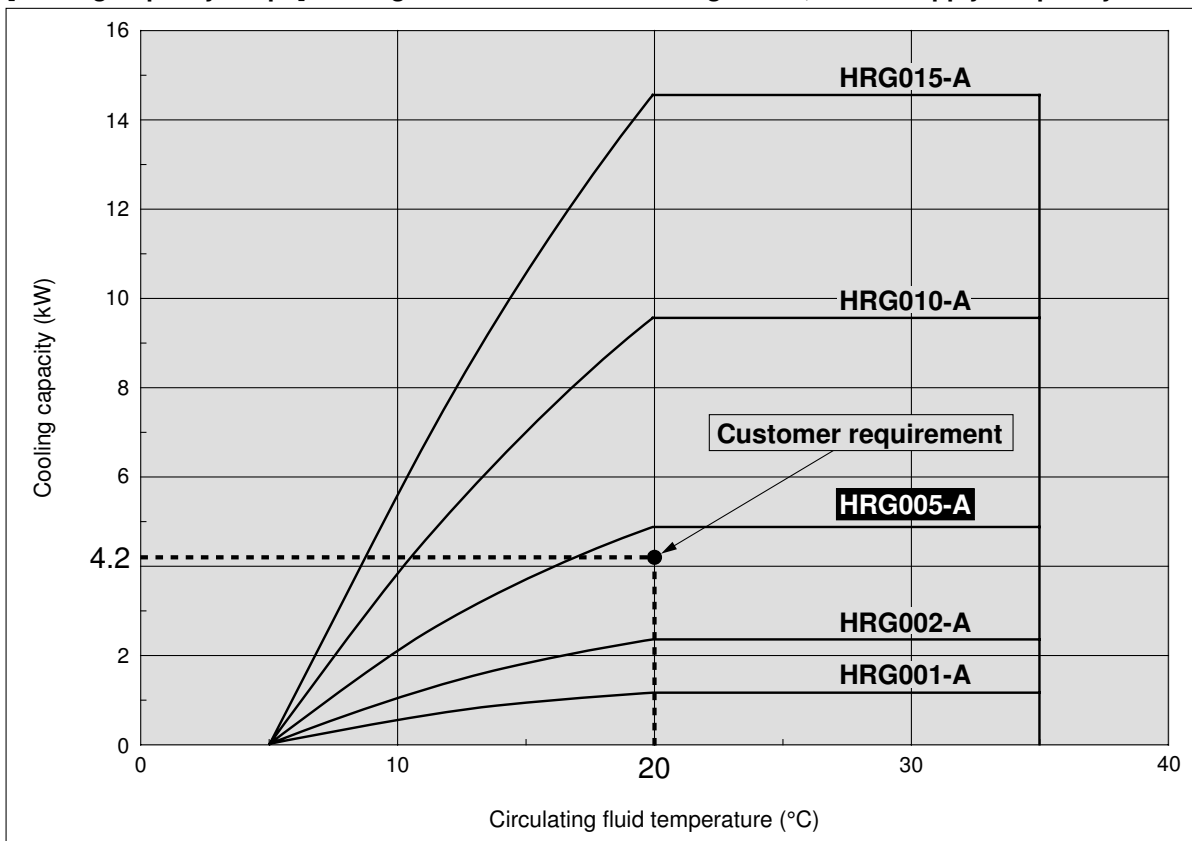

The point plotted in the graph is the requirement from your customer. Select the Thermo-cooler models exceeding this point. In this case, select the **HRG005-A**.

HRG
 HRGC
 HRZ
 HRW
 HEC
 HEB
 HED
 Technical Data
 Related Products

Model Selection

Calculation of Required Cooling Capacity

Example 1: When the heat generation amount in the customer's equipment is known.

The heat generation amount can be determined based on the power consumption or output of the heat generating area — i.e. the area requiring cooling — within your facility.*

(1) Derive the amount of heat generated from the power consumption.

Power consumption P: 3.5 [kW]

$$Q = P = 3.5 \text{ [kW]}$$

Cooling capacity = Considering a safety factor of 20%,

$$3.5 \text{ [kW]} \times 1.2 = \boxed{4.2 \text{ [kW]}}$$

(2) Derive the amount of heat generated from the power supply output.

Power supply output VI: 4.1 [kVA]

$$Q = P = V \times I \times \text{Power factor}$$

In this example, using a power factor of 0.85:

$$= 4.1 \text{ [kVA]} \times 0.85 = 3.5 \text{ [kW]}$$

Cooling capacity = Considering a safety factor of 20%,

$$3.5 \text{ [kW]} \times 1.2 = \boxed{4.2 \text{ [kW]}}$$

(3) Derive the amount of heat generated from the output.

Output (shaft power, etc.) W: 2.2 [kW]

$$Q = P = \frac{W}{\text{Efficiency}}$$

In this example, use an efficiency of 0.7:

$$= \frac{2.2}{0.7} = 3.14 \text{ [kW]}$$

Cooling capacity = Considering a safety factor of 20%,

$$3.14 \text{ [kW]} \times 1.2 \approx \boxed{3.8 \text{ [kW]}}$$

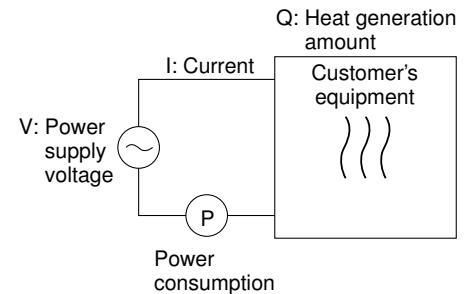

* The above examples calculate the heat generation amount based on the power consumption. The actual heat generation amount may differ due to the structure of customer facilities. Please be sure to check it carefully.

Example 2: When the heat generation amount in the customer's equipment is not known.

Obtaining the temperature difference between inlet and outlet by circulating the circulating fluid inside the customer's equipment.

Amount of heat generated by equipment Q : Unknown [kW] ([kJ/s])
 Circulating fluid : Clear water*
 Circulating fluid flow rate (mass) q_m : ($= \rho \times q_v \div 60$) [kg/s]
 Circulating fluid density ρ : 1 [kg/l]
 Circulating fluid flow rate (volume) q_v : 25 [l/min]
 Circulating fluid specific heat capacity C : 4.2 [kJ/(kg·K)]
 Circulating fluid outlet temperature T_1 : 293 [K] (20 [°C])
 Circulating fluid return temperature T_2 : 295 [K] (22 [°C])
 Circulating fluid temperature difference ΔT : 2.0 [K] ($= T_2 - T_1$)
 Conversion factor: minutes to seconds : 60 [s/min]
 (SI units)

* Refer to page 13 for the typical physical property value of clear water or other circulating fluids.

$$\begin{aligned}
 Q &= q_m \times C \times (T_2 - T_1) \\
 &= \frac{\rho \times q_v \times C \times \Delta T}{60} \\
 &= \frac{1 \times 25 \times 4.2 \times 2.0}{60} \\
 &= 3.50 \text{ [kJ/s]} \approx 3.5 \text{ [kW]}
 \end{aligned}$$

Cooling capacity = Considering a safety factor of 20%,
 $3.5 \text{ [kW]} \times 1.2 = 4.2 \text{ [kW]}$

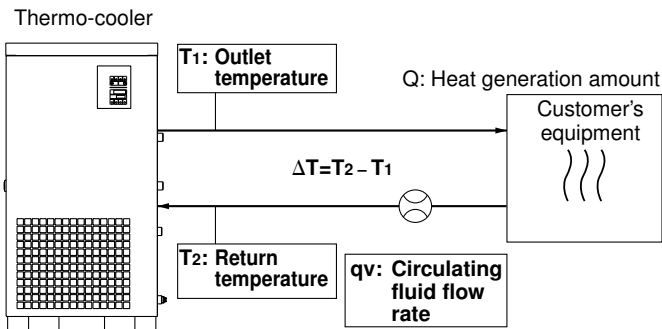

Example of the conventional measurement units (Reference)

Amount of heat generated by equipment Q : Unknown [kcal/h] → [kW]
 Circulating fluid : Clear water*
 Circulating fluid flow rate (weight) q_m : ($= \rho \times q_v \times 60$) [kgf/h]
 Circulating fluid weight: volume ratio γ : 1 [kgf/l]
 Circulating fluid flow rate (volume) q_v : 25 [l/min]
 Circulating fluid specific heat capacity C : 1.0 [kcal/(kgf·°C)]
 Circulating fluid outlet temperature T_1 : 20 [°C]
 Circulating fluid return temperature T_2 : 22 [°C]
 Circulating fluid temperature difference ΔT : 2.0 [°C] ($= T_2 - T_1$)
 Conversion factor: hours to minutes : 60 [min/h]
 Conversion factor: kcal/h to kW : 860 [(kcal/h)/kW]

$$\begin{aligned}
 Q &= \frac{q_m \times C \times (T_2 - T_1)}{860} \\
 &= \frac{\gamma \times q_v \times 60 \times C \times \Delta T}{860} \\
 &= \frac{1 \times 25 \times 60 \times 1.0 \times 2.0}{860} \\
 &= \frac{3000 \text{ [kcal/h]}}{860} \\
 &\approx 3.5 \text{ [kW]}
 \end{aligned}$$

Cooling capacity = Considering a safety factor of 20%,
 $3.5 \text{ [kW]} \times 1.2 = 4.2 \text{ [kW]}$

HRG

HRGC

HRZ

HRW

HEC

HEB

HED

Technical Data

Related Products

Model Selection

Calculation of Required Cooling Capacity

Example 3: When there is no heat generation, and when cooling the object below a certain temperature and period of time.

Heat dissipated by cooled substance: Unknown [kW] ([kJ/s])
(per unit time) Q

Cooled substance : Water
 Cooled substance mass m : (= ρ x V) [kg]
 Cooled substance density ρ : 1 [kg/ℓ]
 Total volume of the object being cooled down V : 60 [ℓ]
 Specific heat capacity of cooled substance C : 4.2 [kJ/(kg·K)]
 Temperature of cooled substance when cooling begins T₀ : 305 [K] (32 [°C])
 Cooled substance temperature after t hour T_t : 293 [K] (20 [°C])
 Cooling temperature difference ΔT : 12 [K] (=T₀ - T_t)
 Cooling time Δt : 900 [s] (= 15 [min])

* Refer to page 13 for the typical physical property values by circulating fluid.

$$Q = \frac{m \times C \times (T_t - T_0)}{\Delta t}$$

$$= \frac{\rho \times V \times C \times \Delta T}{\Delta t}$$

$$= \frac{1 \times 60 \times 4.2 \times 12}{900}$$

$$= 3.36 \text{ [kJ/s]} \approx 3.4 \text{ [kW]}$$

Cooling capacity = Considering a safety factor of 20%,

$$3.4 \text{ [kW]} \times 1.2 = 4.08 \text{ [kW]}$$

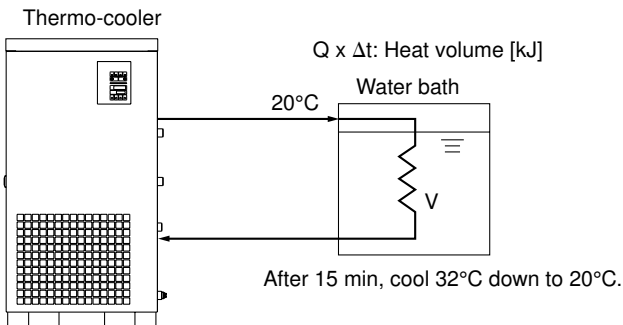

Note) This is the calculated value by changing the fluid temperature only.
 Thus, it varies substantially depending on the water bath or piping shape.

Example of the conventional measurement units (Reference)

Heat dissipated by cooled substance (per unit time) Q : Unknown [kcal/h] → [kW]
 Cooled substance : Water
 Cooled substance weight m : (= ρ x V) [kgf]
 Cooled substance weight (volume ratio) γ : 1 [kgf/ℓ]
 Total volume of the substance being cooled down V : 60 [ℓ]
 Specific heat capacity of cooled substance C : 1.0 [kcal/(kgf·°C)]
 Temperature of cooled substance when cooling begins T₀ : 32 [°C]
 Cooled substance temperature after t hour T_t : 20 [°C]
 Cooling temperature difference ΔT : 12 [°C] (= T₀ - T_t)
 Cooling time Δt : 15 [min]
 Conversion factor: hours to minutes : 60 [min/h]
 Conversion factor: kcal/h to kW : 860 [(kcal/h)/kW]

$$Q = \frac{m \times C \times (T_t - T_0)}{\Delta t \times 860}$$

$$= \frac{\gamma \times V \times 60 \times C \times \Delta T}{\Delta t \times 860}$$

$$= \frac{1 \times 60 \times 60 \times 1.0 \times 12}{15 \times 860}$$

$$= \frac{2880 \text{ [kcal/h]}}{860} \approx 3.4 \text{ [kW]}$$

Cooling capacity = Considering a safety factor of 20%,

$$3.4 \text{ [kW]} \times 1.2 = 4.08 \text{ [kW]}$$

Precautions on Model Selection

1. Heating capacity

If the circulating fluid is to be set at a higher temperature than room temperature, the Thermo-cooler will heat the fluid. However, the Thermo-cooler has a lower heating capacity than a dedicated heater.

2. Pump capacity

<Circulating fluid flow>

Pump capacity varies depending on the model selected from the HRG series. Also, circulating fluid flow varies depending on the circulating fluid discharge pressure. Consider the installation height difference between our cooler and a customer's equipment, and the piping resistance such as circulating fluid pipings, or piping size, or piping curves in the equipment. Confirm beforehand if the required flow is achieved using the pump capacity curves for each respective model.

<Circulating fluid discharge pressure>

Circulating fluid discharge pressure has the possibility to increase up to the maximum pressure in the pump capacity curves for the respective model. Confirm beforehand if the circulating fluid pipings or circulating fluid circuit of the customer's equipment are fully durable against this pressure.

Circulating Fluid Typical Physical Property Values

1. This catalog uses the following values for density and specific heat capacity in calculating the required cooling capacity.

Density ρ : 1 [kg/ℓ] (or, using conventional unit system, weight: volume ratio $\gamma = 1$ [kgf/ℓ])
 Specific heat capacity C: 4.2 [kJ/(kg·K)] (or, using conventional unit system of units, 1 [kcal/(kgf·°C)])

2. Values for density and specific heat capacity change slightly according to temperature as shown in the below table. Use this as a reference. Note)

Water

Temperature	Physical property value	Density ρ [kg/ℓ]	Specific heat C [kJ/(kg·K)]	Conventional unit system	
				Weight: volume ratio γ [kgf/ℓ]	Specific heat C [kcal/(kgf·°C)]
5°C		1.00	4.20	1.00	1.00
10°C		1.00	4.19	1.00	1.00
15°C		1.00	4.19	1.00	1.00
20°C		1.00	4.18	1.00	1.00
25°C		1.00	4.18	1.00	1.00
30°C		1.00	4.18	1.00	1.00
35°C		0.99	4.18	0.99	1.00

Aqueous Solution of 15% Ethylene Glycol

Temperature	Physical property value	Density ρ [kg/ℓ]	Specific heat C [kJ/(kg·K)]	Conventional unit system	
				Weight: volume ratio γ [kgf/ℓ]	Specific heat C [kcal/(kgf·°C)]
5°C		1.02	3.91	1.02	0.93
10°C		1.02	3.91	1.02	0.93
15°C		1.02	3.91	1.02	0.93
20°C		1.01	3.91	1.01	0.93
25°C		1.01	3.91	1.01	0.93
30°C		1.01	3.91	1.01	0.94
35°C		1.01	3.92	1.01	0.94

* The above shown are reference values. Please contact circulating fluid manufacturers for details.

Thermo-cooler Series HRG

How to Order



HRG 001 - A - -

Cooling capacity

001	Cooling capacity: 0.9/1.1 kW (50/60 Hz)
002	Cooling capacity: 1.9/2.3 kW (50/60 Hz)
005	Cooling capacity: 4.5/4.8 kW (50/60 Hz)
010	-A Cooling capacity: 9.0/9.5 kW (50/60 Hz)
	-W Cooling capacity: 10.0/11.0 kW (50/60 Hz)
015	-A Cooling capacity: 13.0/14.5 kW (50/60 Hz)
	-W Cooling capacity: 14.5/16.5 kW (50/60 Hz)

Cooling method

A	Air-cooled refrigeration
W	Water-cooled refrigeration

Option

Nil	None
A	With casters
B	With ground fault circuit interrupter
C	With communications function (RS485)

* Refer to pages 26 and 27 for the specifications of each option.

Temperature stability

Nil	±1.0°C (Refrigerator ON/OFF control)
5	±0.5°C (Proportional valve PID control)

* Only models HRG001–HRG005 are applicable for proportional valve PID control.

Specifications

HRG001/002/005

Model		HRG001		HRG002		HRG005	
Cooling method		Air-cooled refrigeration	Water-cooled refrigeration	Air-cooled refrigeration	Water-cooled refrigeration	Air-cooled refrigeration	Water-cooled refrigeration
Refrigerant		R407C (HFC)					
Control method		Refrigerator ON/OFF control or Proportional valve PID control					
Ambient temperature/humidity <small>Note 1)</small>		Temperature: –5 to 40°C, Humidity: 30 to 70%RH					
Circulating fluid system	Circulating fluid <small>Note 2)</small>	Clear water, Deionized water, Aqueous solution of 15% ethylene glycol					
	Temperature range setting <small>Note 1)</small> (°C)	5 to 35					
	Cooling capacity <small>Note 3)</small> (50/60 Hz) (kW)	0.9/1.1 (at 20°C)	0.9/1.1 (at 20°C)	1.9/2.3 (at 20°C)	1.9/2.3 (at 20°C)	4.5/4.8 (at 20°C)	4.5/4.8 (at 20°C)
	Heating capacity <small>Note 4)</small> (kW)	—	—	—	—	—	—
	Temperature stability <small>Note 5)</small> (°C)	±1.0 (Refrigerator ON/OFF control), ±0.5 (Proportional valve PID control)					
	Pump capacity <small>Note 6)</small> (50/60 Hz) (MPa)	0.14/0.19 (at 8/10 ℓ/min, total lifting height 8/9 m)		0.14/0.19 (at 10/10 ℓ/min, total lifting height 11/16 m)		0.2/0.26 (at 24/32 ℓ/min, total lifting height 14/15 m)	
	Rated flow <small>Note 7)</small> (50/60 Hz) (ℓ/min)	8/10		10/10		24/32	
Tank capacity (ℓ)	10				20		
Port size	Rc 1/2						
Wetted parts material	Stainless steel, Brass, PE, PVC, PPE, Copper brazing (Heat exchanger)				Stainless steel, PE, PVC, Brass, Copper brazing (Heat exchanger)		
Facility water system	Temperature range (°C)	—	5 to 32	—	5 to 32	—	5 to 32
	Pressure range (MPa)	—	0.2 to 0.5	—	0.2 to 0.5	—	0.2 to 0.5
	Required flow rate <small>Note 8)</small> (50/60 Hz) (ℓ/min)	—	10/12	—	12/15	—	27/28
	Port size	—	Rc 1/2	—	Rc 1/2	—	Rc 1/2
Wetted parts material	Stainless steel, Brass, PVC, Copper brazing (Heat exchanger)						
Electrical system	Power supply	3-phase 200 VAC 50 Hz, 3-phase 200 to 220 VAC 60 Hz Allowable voltage fluctuation ±10%					
	Applicable ground fault circuit interrupter capacity <small>Note 9)</small> (A)	5		10		20	
	Rated operating current (50/60 Hz) (A)	2.85/2.85	2.6/2.65	5.0/5.5	4.2/4.3	8.0/9.5	6.3/7.8
	Rated power consumption (50/60 Hz) (kW)	0.66/0.82	0.56/0.72	1.0/1.25	0.84/1.0	1.75/2.35	1.45/2.0
	Remote operation signal input	Remote startup with 24 VDC, 8 mA applied, shutdown at 0 VDC					
	Operation signal output	Relay contact output (switch closed when operating, switch open when stopped, switch open when shut down)					
	Alarm stop signal output	Relay contact output (switch closed when alarm is turned off, switch open when alarm is turned on, switch closed when shut down)					
Alarm	Refer to page 24.						
Mass <small>Note 10)</small> (kg)	70		75		120		115

Note 1) It should have no condensation.

During seasons or in locations where the ambient temperature is likely to fall below freezing point, please use aqueous ethylene glycol solution.

Note 2) If clear water is to be used, please use water that conforms to Clear Water Quality Standard of the Japan Refrigeration and Air Conditioning Industrial Association (JRA GL-02-1994 cooling water system - circulating type - make-up water). If using deionized water, be sure to supply water with an electrical conductivity of 1 μS/cm or more. (Electrical resistivity: 1 MΩ·cm or less.)

If using aqueous ethylene glycol solution, maintain the concentration at 15%.

Note 3) ① Ambient temperature: 32°C, Facility water temperature: 25°C (water-cooled refrigeration), ② Circulating fluid temperature: 20°C, ③ Circulating fluid flow rate: Values at circulating fluid rated flow rate.

Note 4) Thermo-cooler specifications do not have heating capability.

Note 5) Value applies to a stable load state with no outside interference. Actual values may vary depending on the usage conditions.

Note 6) Capacity of the Thermo-cooler outlet when the circulating fluid temperature is at 20°C.

Note 7) Required flow for cooling capacity or maintaining the temperature stability.

When used below the rated flow, open the standard by-pass valve and maintain a circulating fluid flow rate equivalent to the rated flow.

Also, use the individually sold, "By-pass piping set" (Refer to pages 28 through to 35).

Note 8) Required flow when a load is applied as shown in the cooling capacity when the facility water temperature is at 32°C.

Note 9) Purchase a ground fault circuit interrupter with current sensitivity of 30 mA separately. (Option "B" is also available. Refer to "How to Order".)

Note 10) Mass in the dry state without circulating fluids.

Specifications

HRG010/015

Model		HRG010		HRG015	
Cooling method		Air-cooled refrigeration	Water-cooled refrigeration	Air-cooled refrigeration	Water-cooled refrigeration
Refrigerant		R407C (HFC)			
Control method		Refrigerator ON/OFF control			
Ambient temperature/humidity <small>Note 1)</small>		Temperature: -5 to 40°C, Humidity: 30 to 70%RH			
Circulating fluid system	Circulating fluid <small>Note 2)</small>	Clear water, Deionized water, Aqueous solution of 15% ethylene glycol			
	Temperature range setting <small>Note 1)</small> (°C)	5 to 35			
	Cooling capacity <small>Note 3)</small> (50/60 Hz) (kW)	9.0/9.5 (at 20°C)	10.0/11.0 (at 20°C)	13.0/14.5 (at 20°C)	14.5/16.5 (at 20°C)
	Heating capacity <small>Note 4)</small> (kW)	—	—	—	—
	Temperature stability <small>Note 5)</small> (°C)	±1.0			
	Pump capacity <small>Note 6)</small> (50/60 Hz) (MPa)	0.29/0.33 (at 37/49 ℓ/min, total lifting height 25/25 m)		0.28/0.31 (at 42/53 ℓ/min, total lifting height 25/25 m)	
	Rated flow <small>Note 7)</small> (50/60 Hz) (ℓ/min)	37/49		42/53	
	Tank capacity (ℓ)	40		60	
	Port size	Rc 3/4			
	Wetted parts material	Stainless steel, Brass, PVC, Nylon 12, Polyurethane, Copper brazing (Heat exchanger)		Stainless steel, Brass, PVC, Nylon 12, Polyurethane, Copper brazing (Heat exchanger)	
Facility water system	Temperature range (°C)	—	5 to 32	—	5 to 32
	Pressure range (MPa)	—	0.3 to 0.5	—	0.3 to 0.5
	Required flow rate <small>Note 8)</small> (50/60 Hz) (ℓ/min)	—	33/34	—	38/40
	Port size	—	Rc 1/2	—	Rc 3/4
	Wetted parts material	Stainless steel, Brass, Synthetic rubber, Copper brazing (Heat exchanger)			
Electrical system	Power supply	3-phase 200 VAC 50 Hz, 3-phase 200 to 220 VAC 60 Hz Allowable voltage fluctuation ±10%			
	Applicable ground fault circuit interrupter capacity <small>Note 9)</small> (A)	40		60	
	Rated operating current (50/60 Hz) (A)	14/16	12/12.5	21/22	18/19
	Rated power consumption (50/60 Hz) (kW)	4.0/5.0	3.2/3.8	5.5/6.7	4.7/5.8
	Remote operation signal input	Remote startup with 8 mA input at 24 VDC, shutdown at 0 VDC			
	Operation signal output	Relay contact output (switch closed when operating, switch open when stopped, switch open when shut down)			
	Alarm stop signal output	Relay contact output (switch closed when alarm is turned off, switch open when alarm is turned on, switch closed when shut down)			
	Alarm	Refer to page 24.			
	Mass <small>Note 10)</small> (kg)	205	200	230	220

- Note 1) It should have no condensation.
During seasons or in locations where the ambient temperature is likely to fall below freezing point, please use aqueous ethylene glycol solution.
- Note 2) If clear water is to be used, please use water that conforms to Clear Water Quality Standard of the Japan Refrigeration and Air Conditioning Industrial Association (JRA GL-02-1994 cooling water system - circulating type - make-up water). If using deionized water, be sure to supply water with an electrical conductivity of 1 μS/cm or more. (Electrical resistivity: 1 MΩ·cm or less.)
If using aqueous ethylene glycol solution, maintain the concentration at 15%.
- Note 3) ① Ambient temperature: 32°C, Facility water temperature: 25°C (water-cooled refrigeration), ② Circulating fluid temperature: 20°C, ③ Circulating fluid flow rate: Values at circulating fluid rated flow rate.
- Note 4) Thermo-cooler specifications do not have heating capability.
- Note 5) Value applies to a stable load state with no outside interference. Actual values may vary depending on usage conditions.
- Note 6) The capacity of the Thermo-cooler outlet when the circulating fluid temperature is at 20°C.
- Note 7) Required flow for cooling capacity or maintaining the temperature stability.
When used below the rated flow, open the standard by-pass valve and maintain a circulating fluid flow rate equivalent to the rated flow.
Also, use the individually sold, "By-pass piping set" (Refer to pages 28 through to 35).
- Note 8) Required flow when a load is applied as shown in the cooling capacity when the facility water temperature is at 32°C.
- Note 9) Purchase a ground fault circuit interrupter with current sensitivity of 30 mA separately. (Option "B" is also available. Refer to "How to Order".)
- Note 10) Mass in the dry state without circulating fluids.

HRG
HRGC
HRZ
HRW
HEC
HEB
HED
Technical Data
Related Products

Series HRG

Cooling Capacity

HRG001-A, HRG001-W

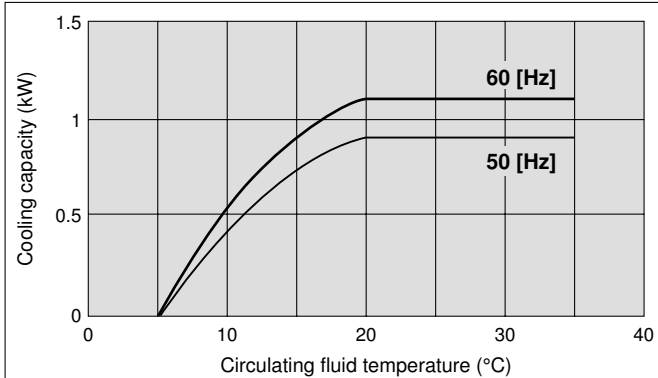

HRG002-A, HRG002-W

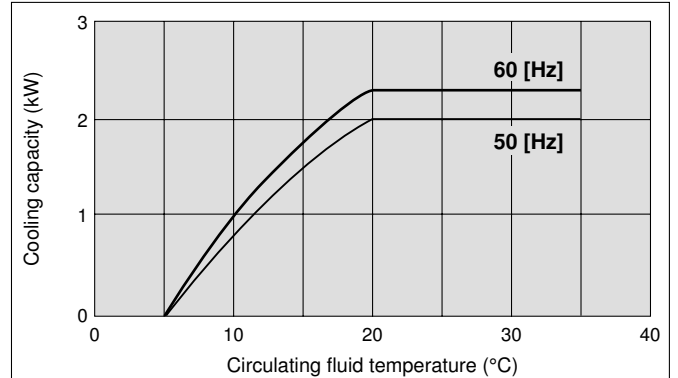

HRG005-A, HRG005-W

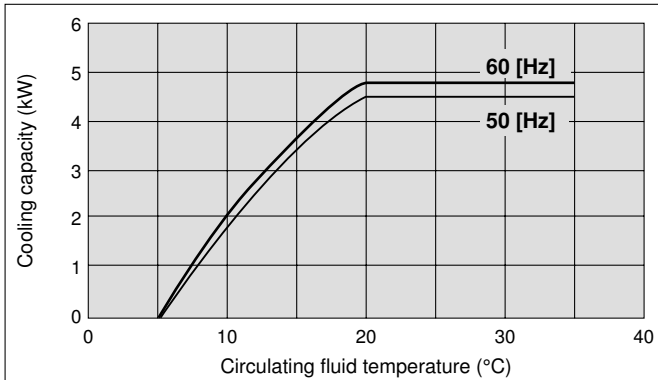

HRG010-A

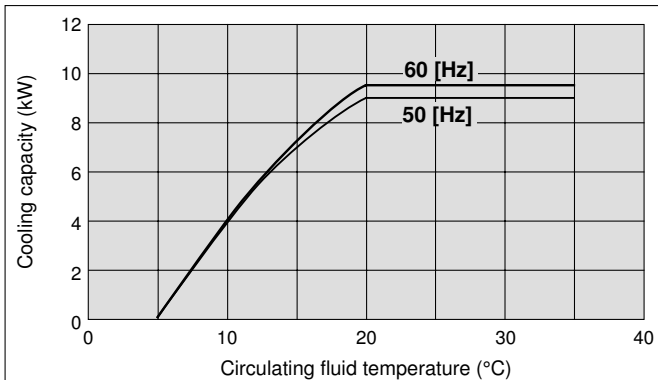

HRG010-W

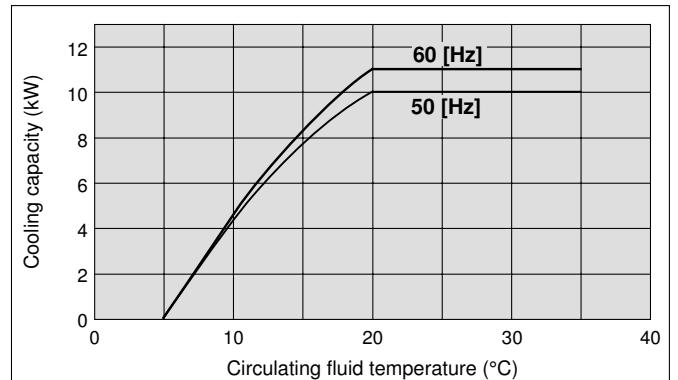

HRG015-A

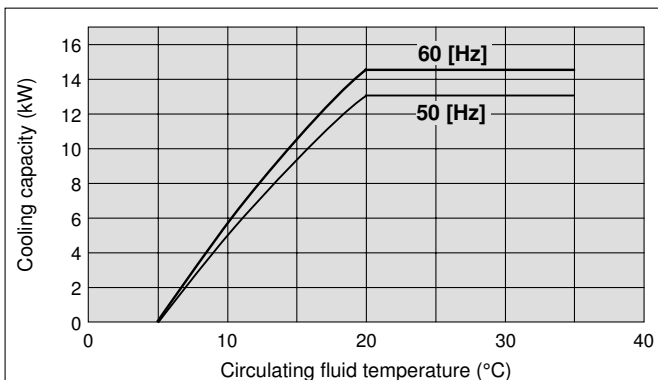

HRG015-W

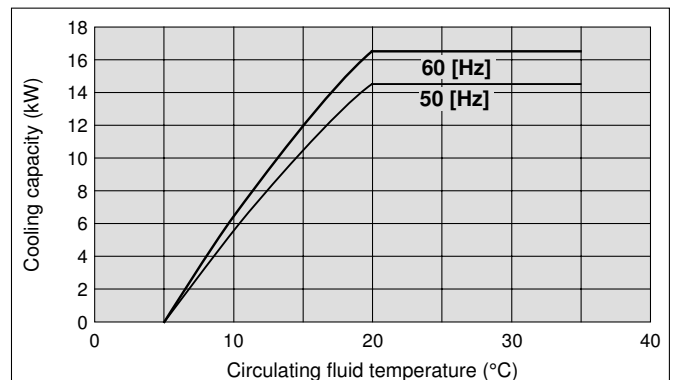

Pump Capacity

HRG001-A, HRG001-W

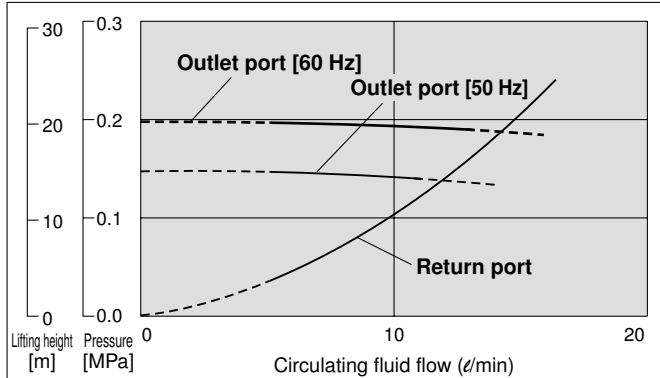

HRG002-A, HRG002-W

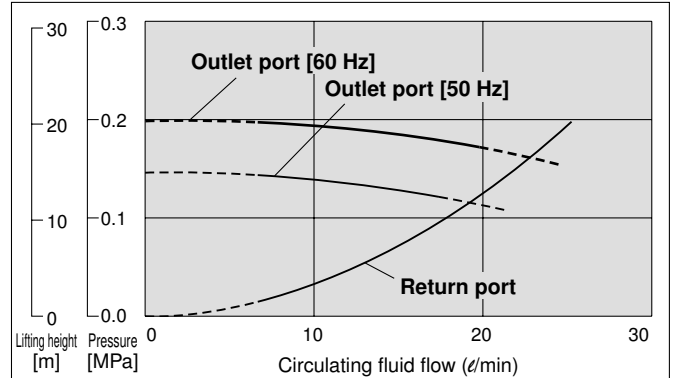

HRG005-A, HRG005-W

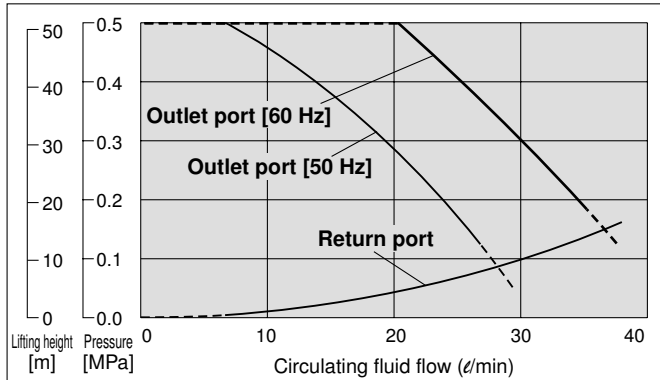

HRG010-A, HRG010-W

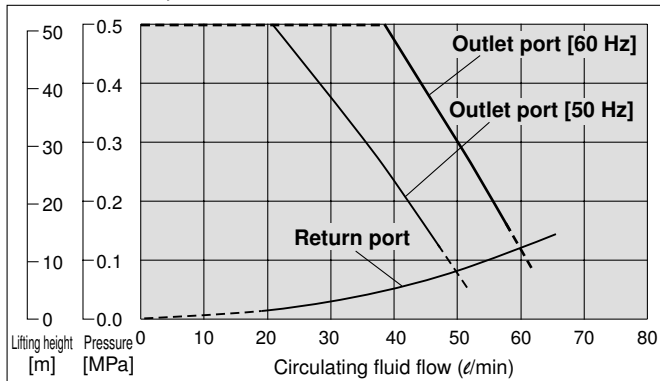

HRG015-A, HRG015-W

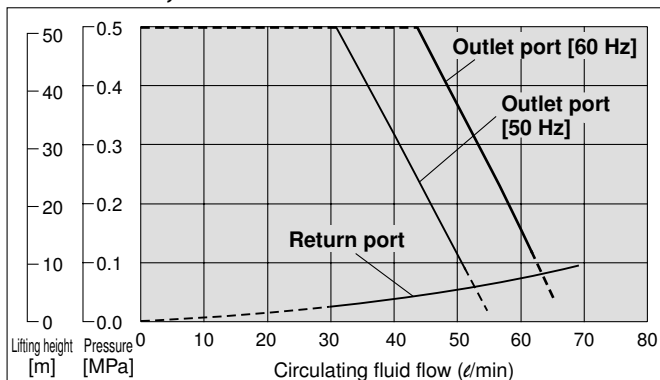

* For all common models, temperature stability will decline in the flow rate range where circulating fluid is deduced (dotted line). Also, in this range, the circulating fluid outlet pressure will exceed the maximum operating pressure (0.5 MPa) (HRG005 to HRG015).

Facility Water Required Flow Rate

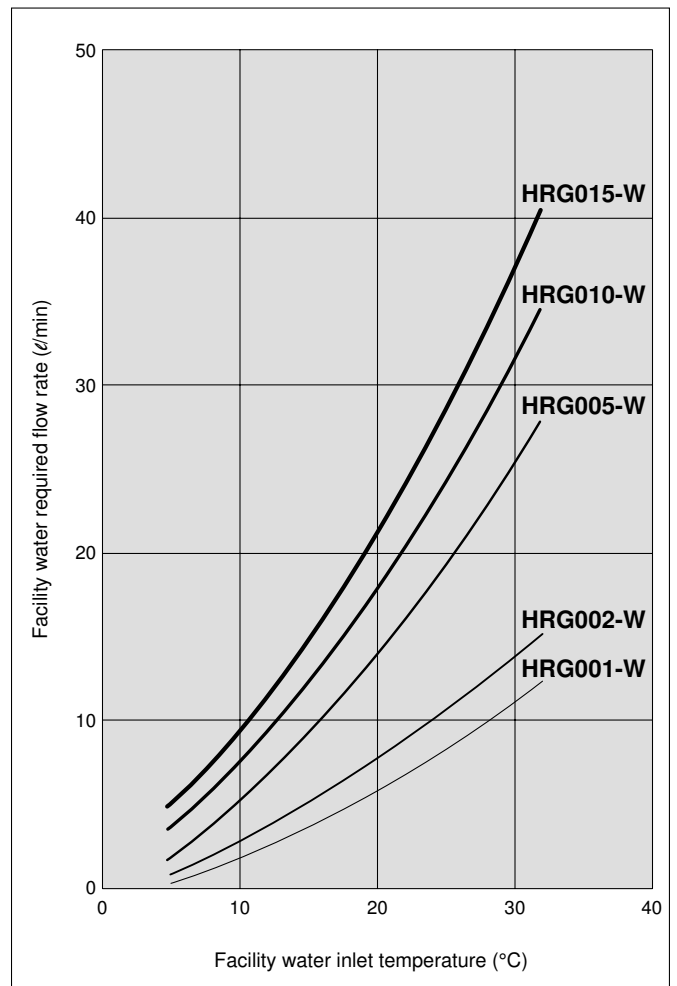

* This is the required flow rate of facility water at the rated cooling capacity and circulating fluid flow, operating at 60 Hz, when the facility water inlet temperature is between 5°C and 32°C.

HRG
HRGC
HRZ
HRW
HEC
HEB
HED
Technical Data
Related Products

Series HRG

Dimensions: Air-Cooled Refrigeration

HRG001-A (-A)

HRG002-A (-A)

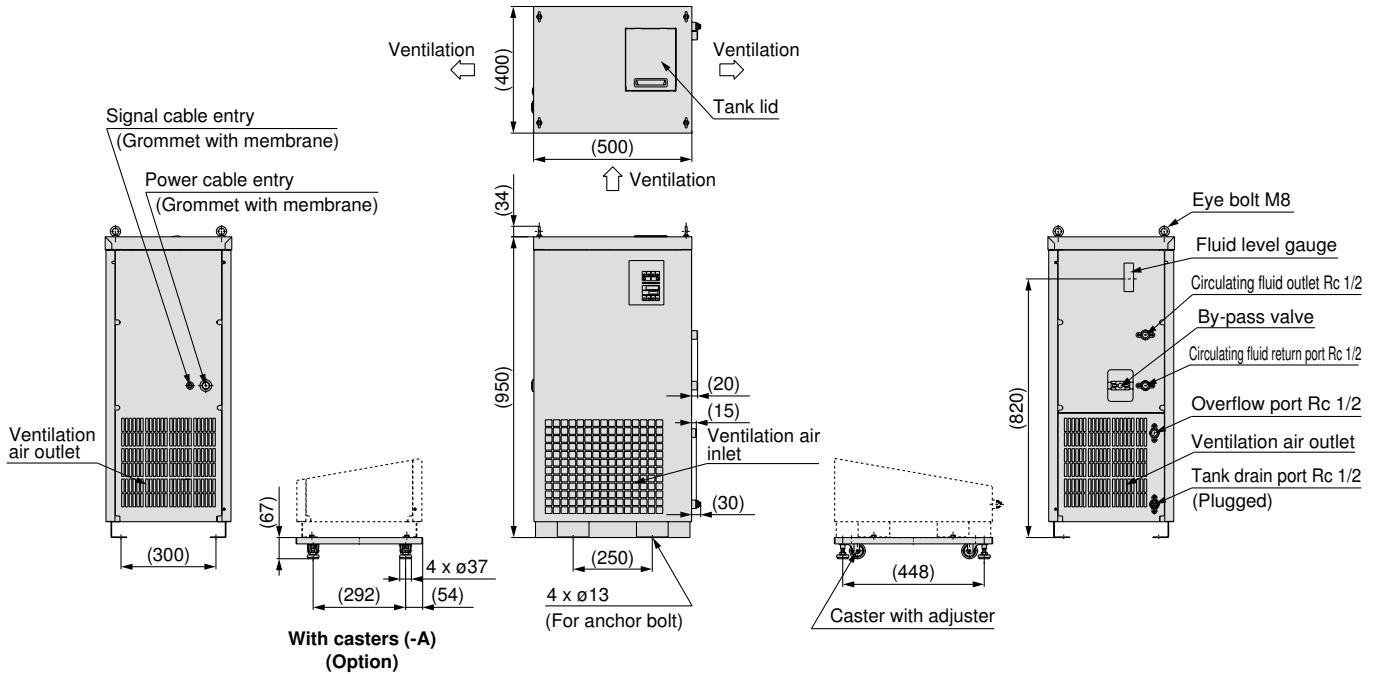

HRG005-A (-A)

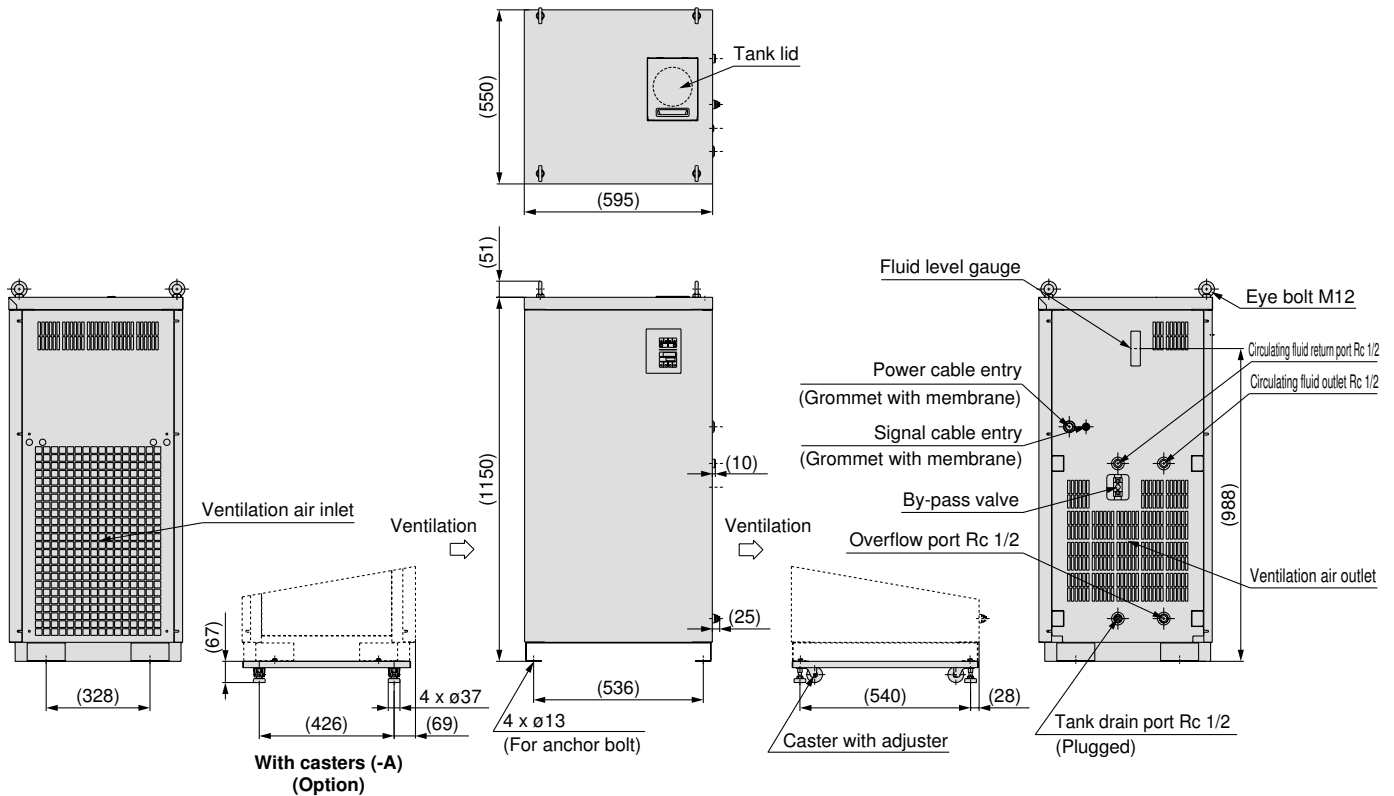

Dimensions: Air-Cooled Refrigeration

HRG010-A (-A)

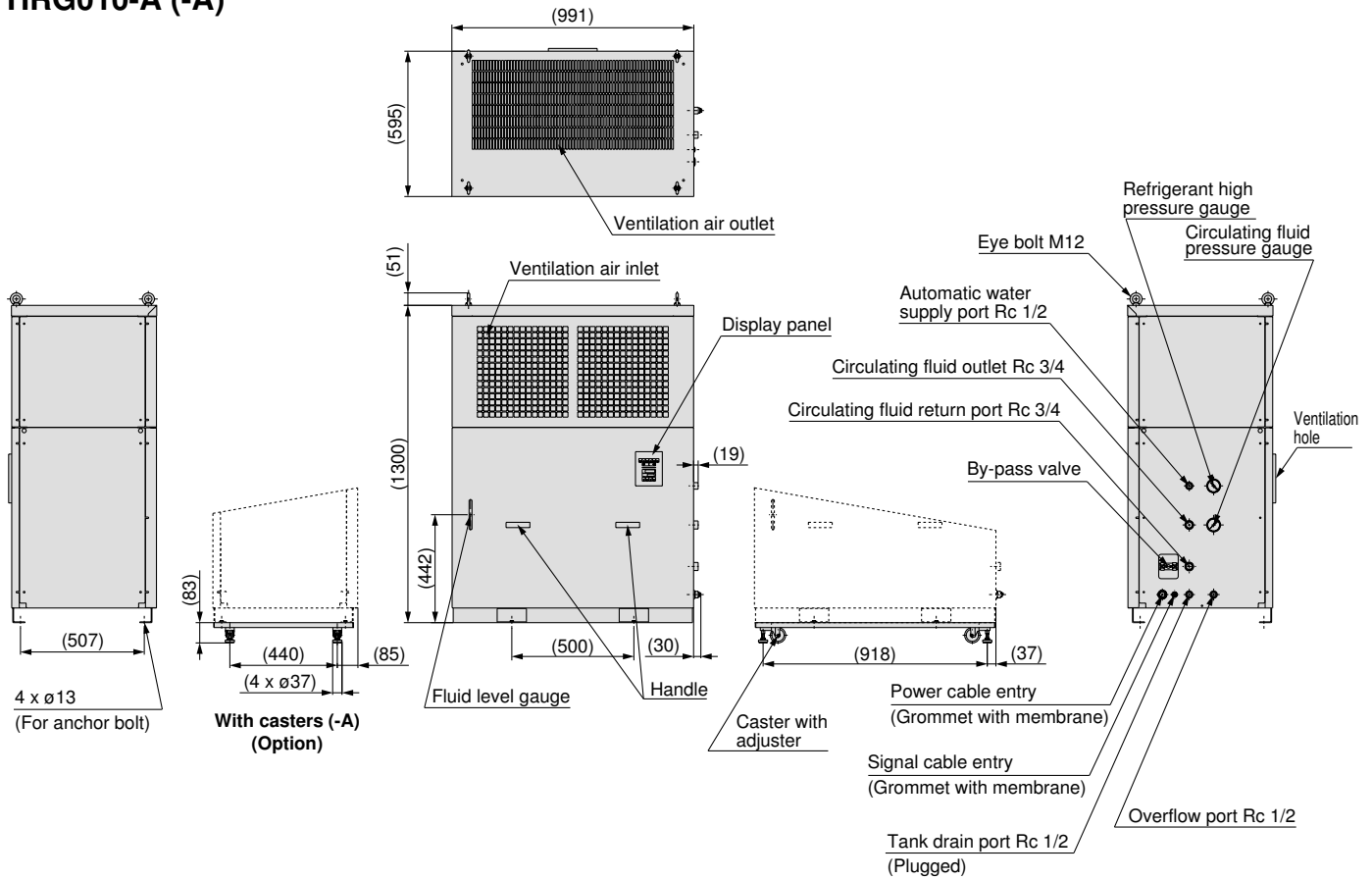

HRG015-A (-A)

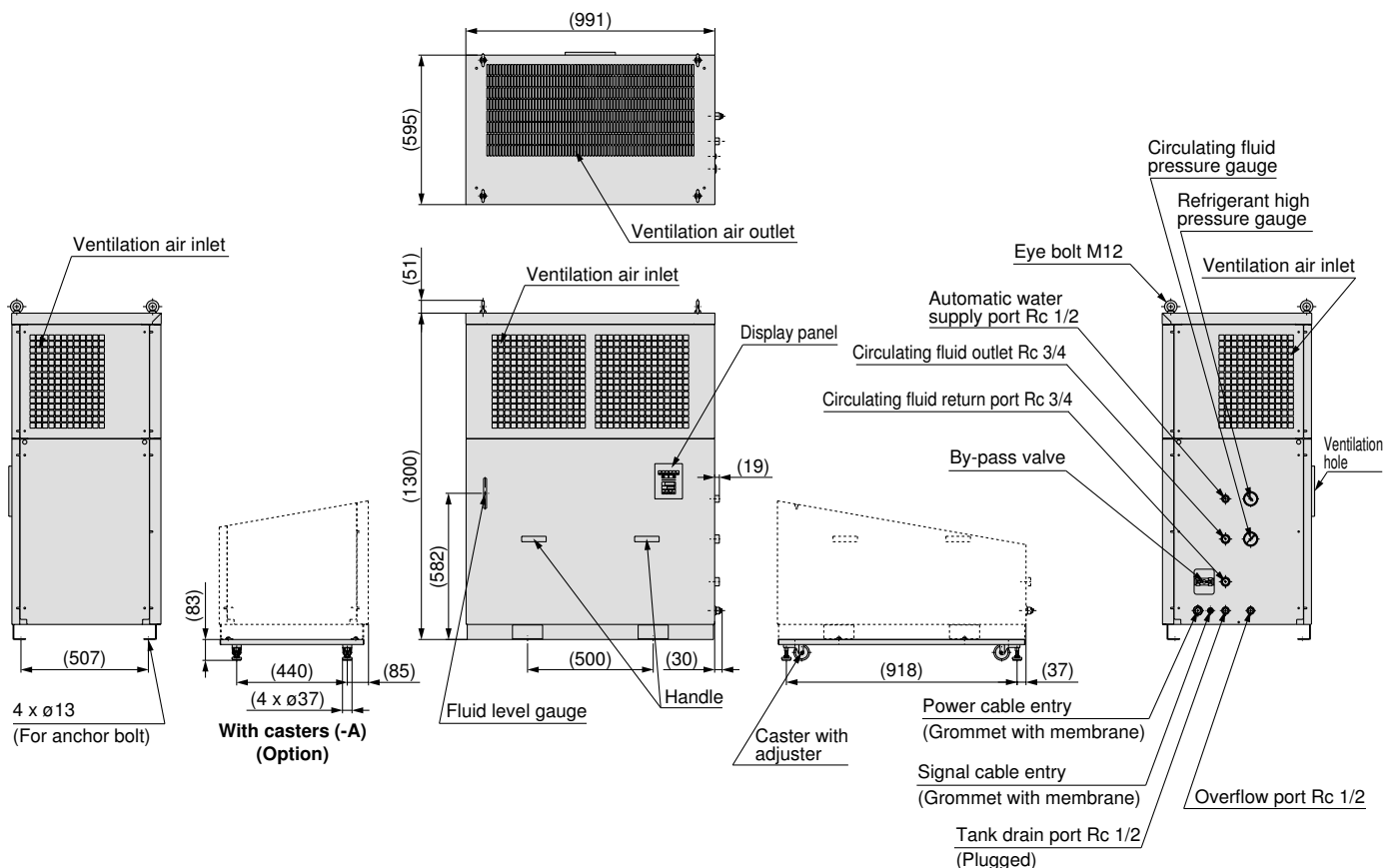

HRG
HRGC
HRZ
HRW
HEC
HEB
HED
Technical Data
Related Products

Series HRG

Dimensions: Water-Cooled Refrigeration

HRG001-W (-A)

HRG002-W (-A)

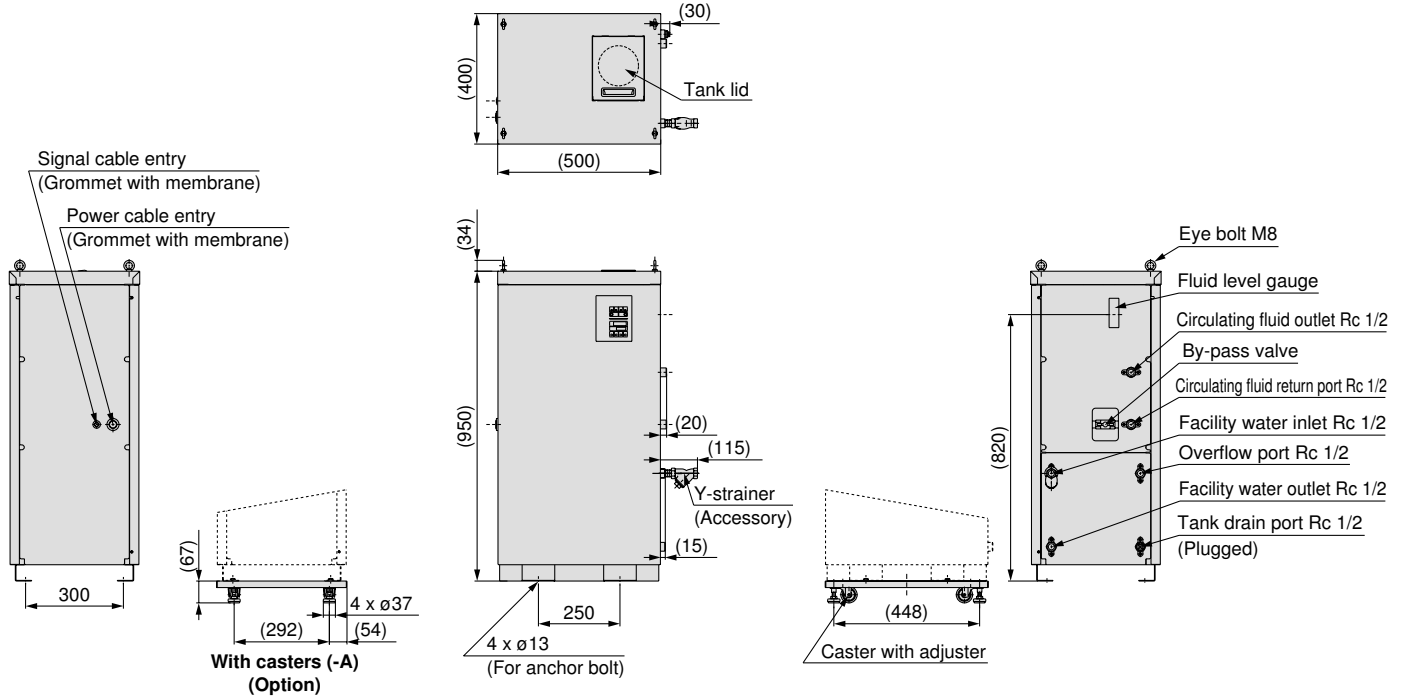

HRG005-W (-A)

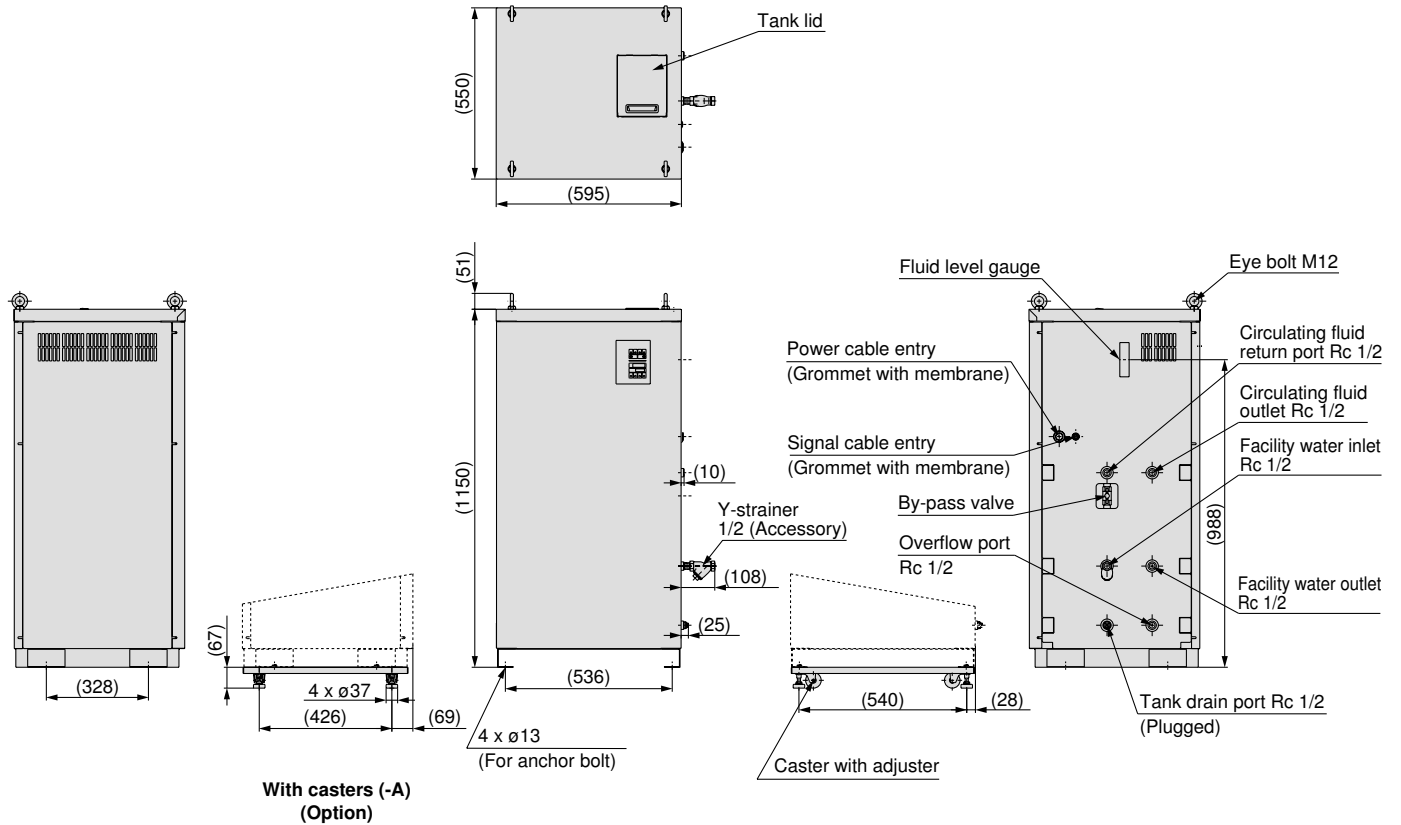

Dimensions: Water-Cooled Refrigeration

HRG010-W (-A)

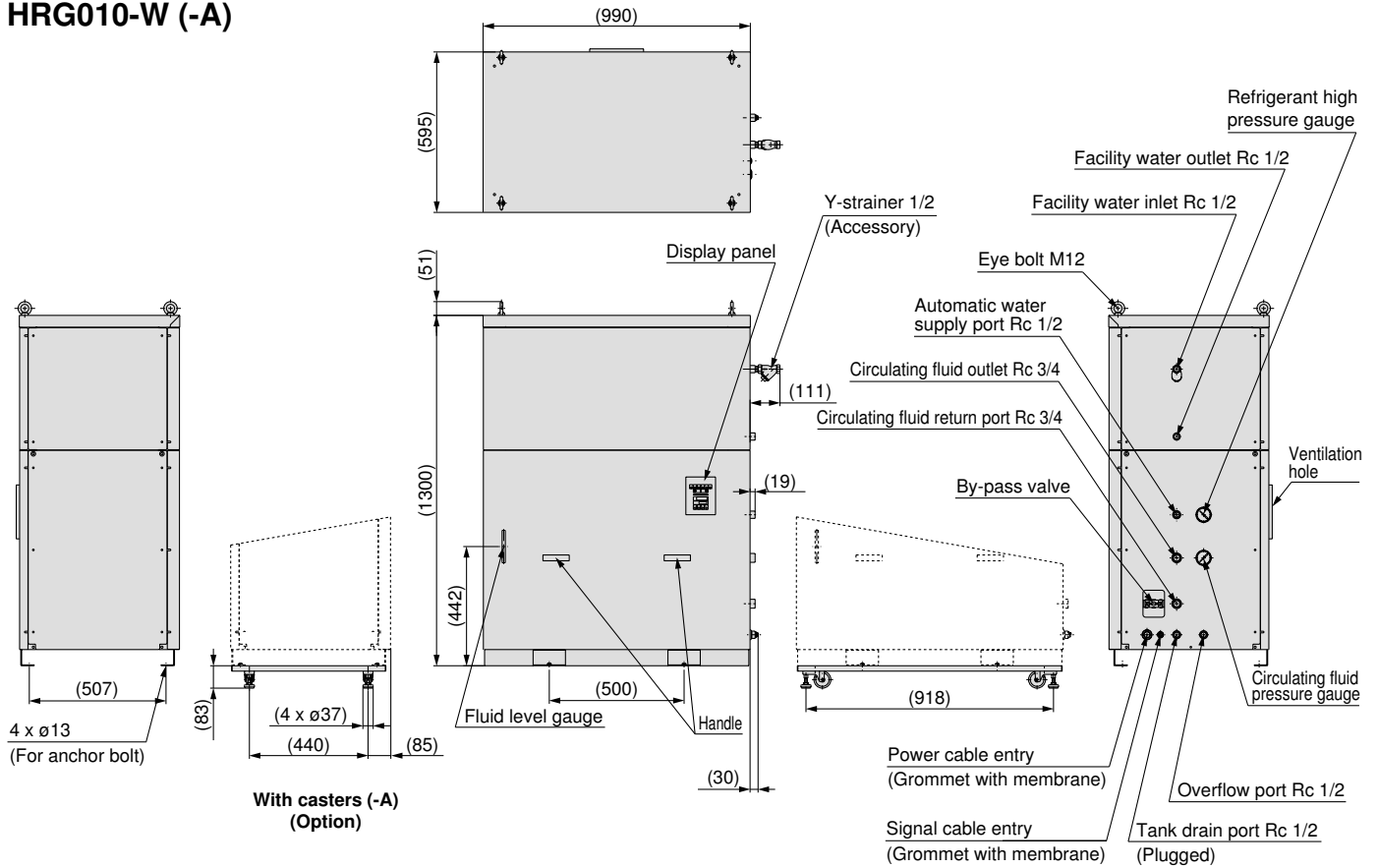

HRG015-W (-A)

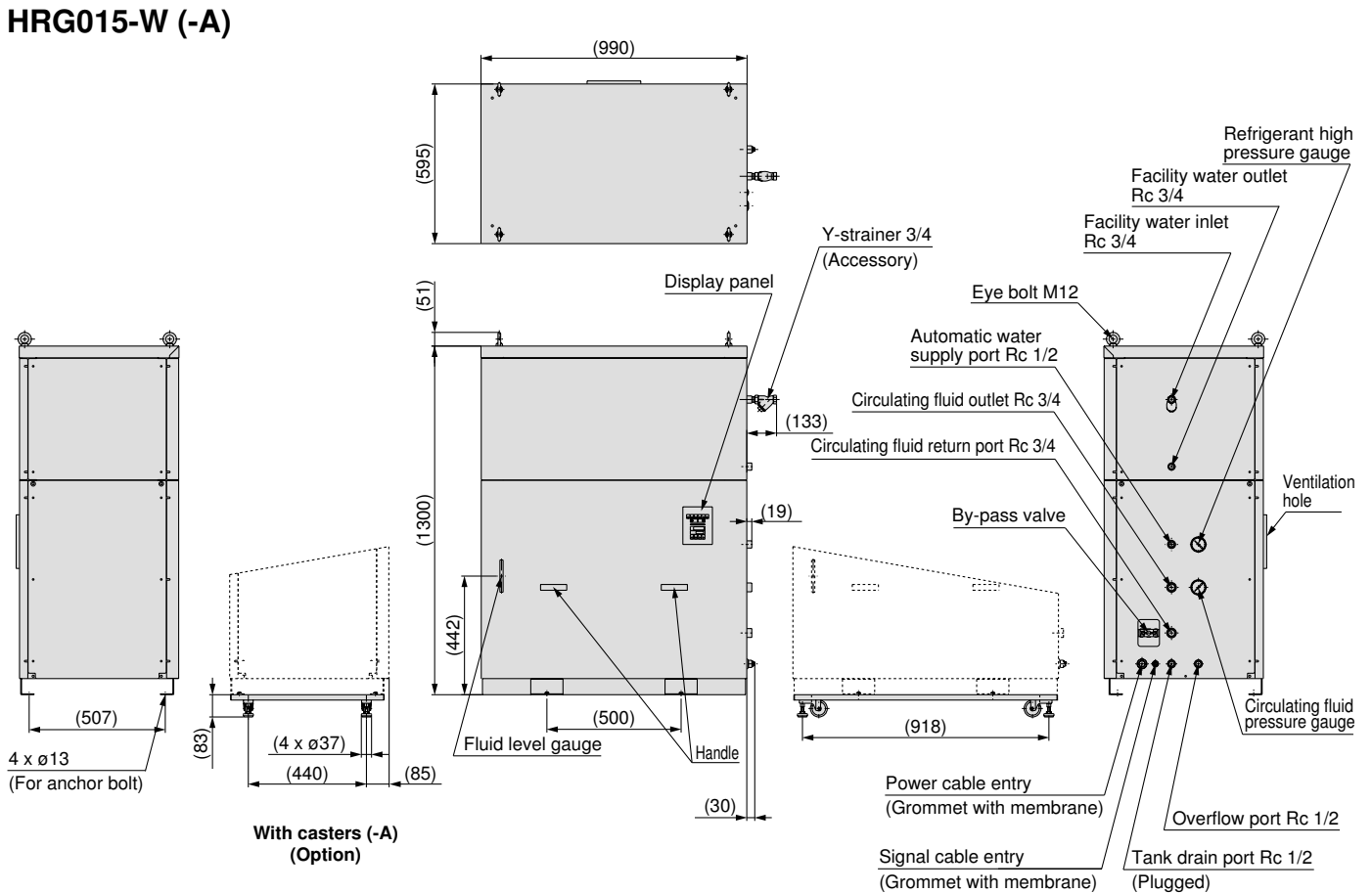

HRG
HRGC
HRZ
HRW
HEC
HEB
HED
Technical Data
Related Products

Series HRG

Piping Connection and Installation Dimensions

HRG001/002

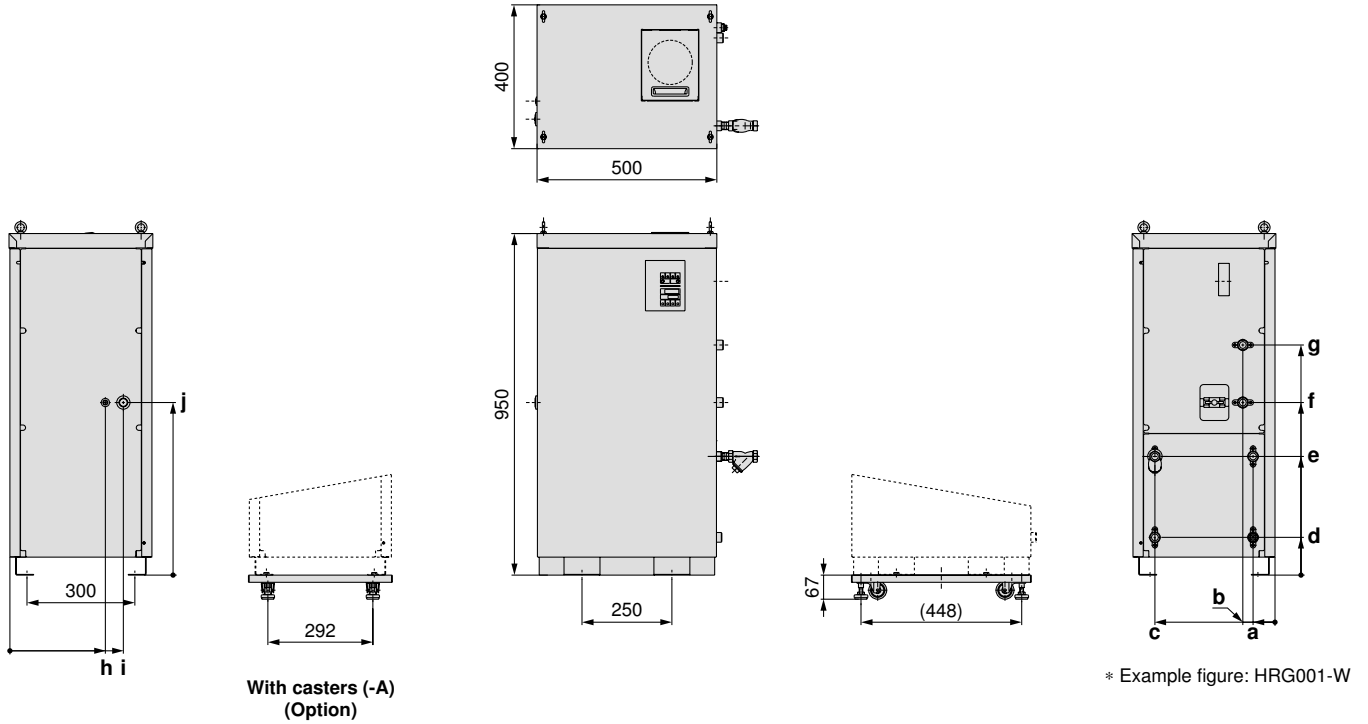

HRG005

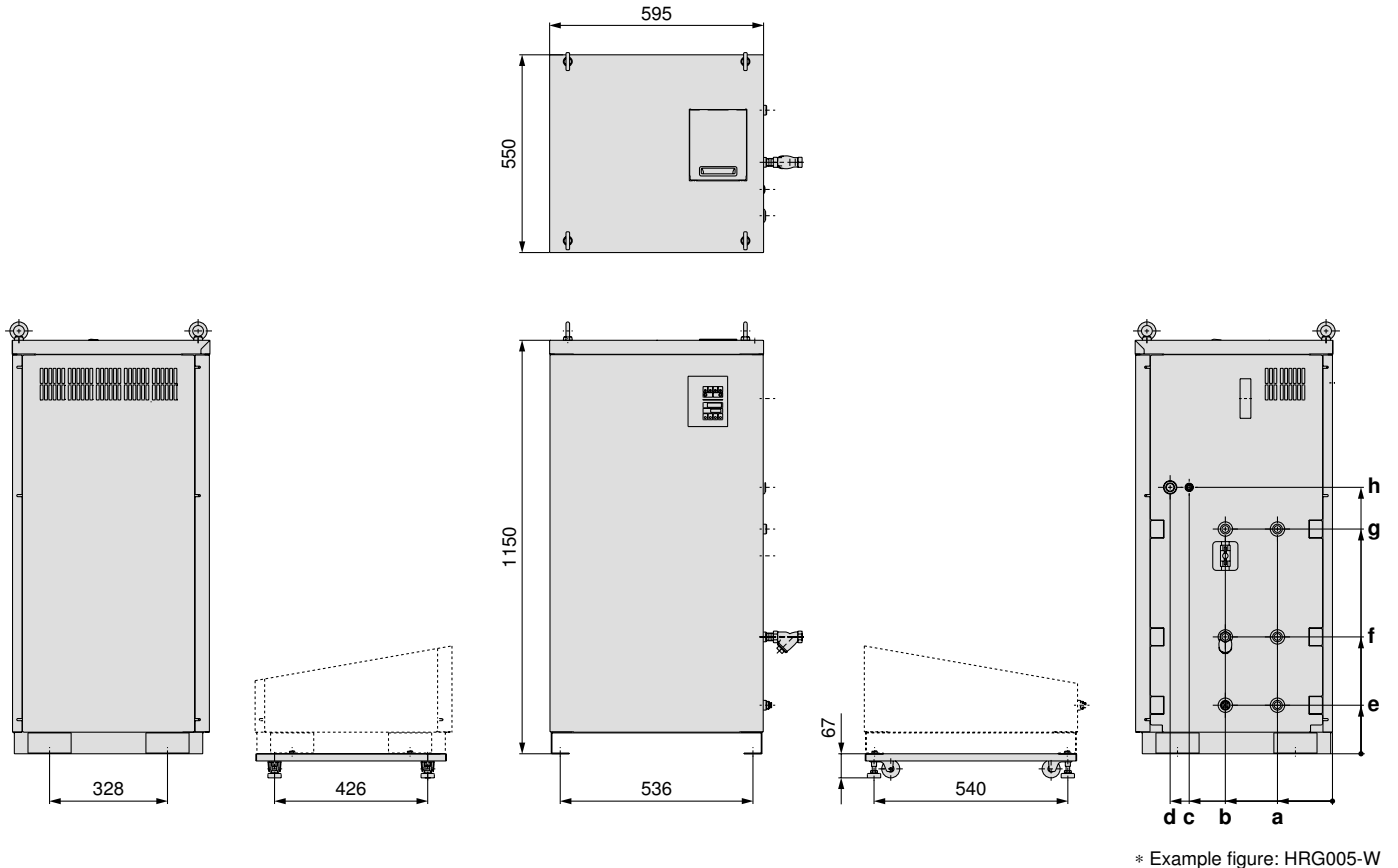

Piping Connection and Installation Dimensions

HRG010/015

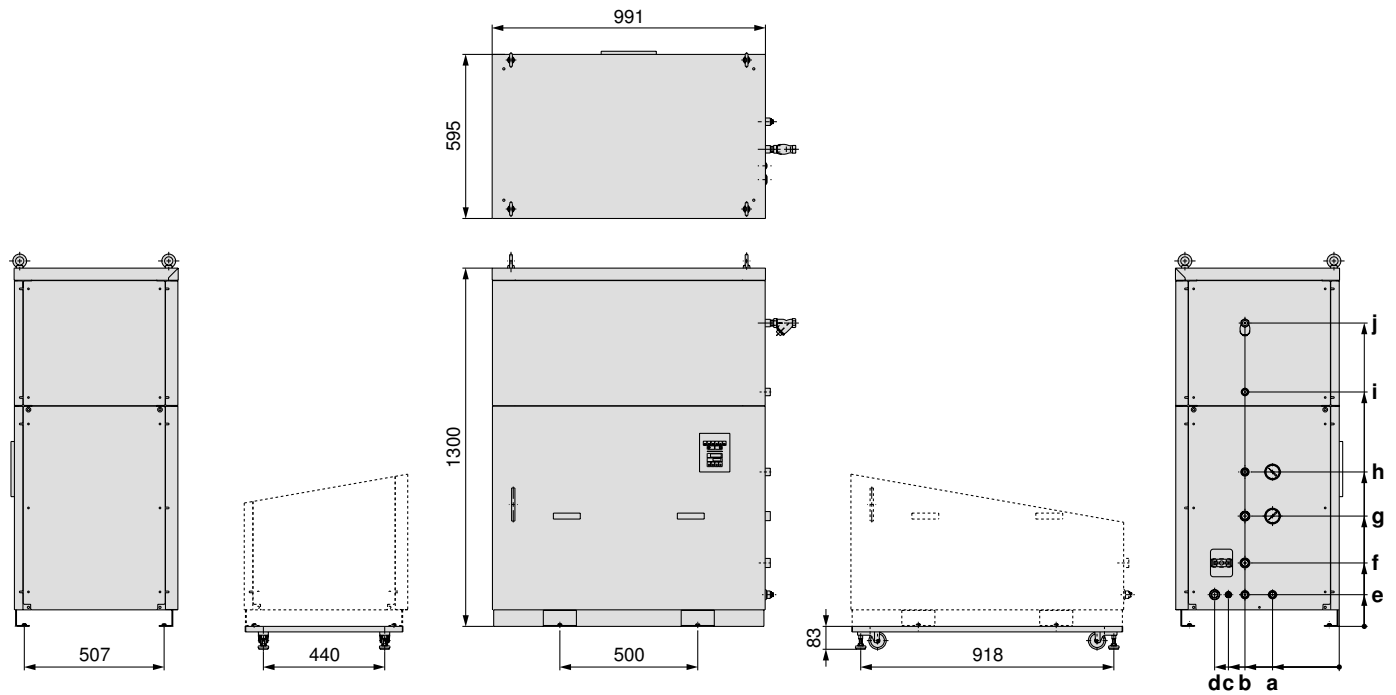

* Example figure: HRG010-W

Model	a	b	c	d	e	f	g	h	i	j
HRG001-A	61	94.5	—	105	330	480	640	265.5	315.5	480
HRG001-W	61	94.5	334	105	330	480	640	265.5	315.5	480
HRG002-A	61	94.5	—	105	330	480	640	265.5	315.5	480
HRG002-W	61	94.5	334	105	330	480	640	265.5	315.5	480
HRG005-A	153	298	398.5	451.5	135	—	625	741		
HRG005-W	153	298	398.5	451.5	135	325	625	741		
HRG010-A	242	342	402	452	115	230	400	560	—	—
HRG010-W	242	342	402	452	115	230	400	560	850	1100
HRG015-A	242	342	402	452	115	230	400	560	—	—
HRG015-W	242	342	402	452	115	230	400	560	850	1100

(mm)

HRG
HRGC
HRZ
HRW
HEC
HEB
HED
Technical Data
Related Products

Operation Panel Display

HRG001/002/005

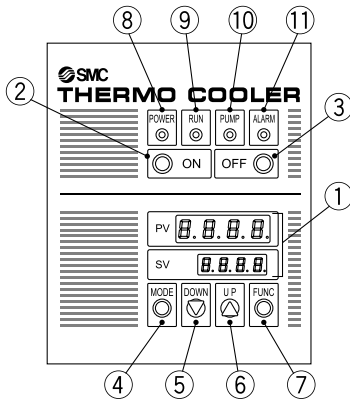

HRG010/015

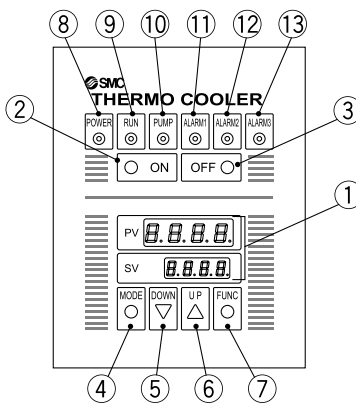

No.	Description	Function	
		HRG001/002/005	HRG010/015
①	Seven-part display screen	PV display	Displays the current temperature of the circulating fluid outlet.
		SV display	Displays the set temperature of the circulating fluid outlet.
②	[ON] switch	Starts the operation.	
③	[OFF] switch	Stops the operation.	
④	[MODE] key ^{Note 1)}	Changes the display between the temperature and control value ^{Note 1)} .	
⑤	[DOWN] key	Reduces the set temperature of the circulating fluid outlet.	
⑥	[UP] key	Increases the set temperature of the circulating fluid outlet.	
⑦	[FUNC] key ^{Note 2)}	Activates functions ^{Note 2)} that have been set.	
⑧	[POWER] indicator	Lights up when the power is being supplied to the unit.	
⑨	[RUN] indicator	Lights up when the unit is running.	
⑩	[PUMP] indicator	Lights up when the pump is running independently, or when the main unit is running.	
⑪	[ALARM] indicator, [ALARM1] indicator	Lights up when ALARM is active.	Lights up when ALARM 1 is active.
⑫	[ALARM2] indicator		Lights up when ALARM 2 is active.
⑬	[ALARM3] indicator		Lights up when ALARM 3 is active.

Note 1) All control values used in normal operation are displayed, but are locked and cannot be changed. It is not necessary to unlock these values except during maintenance.

Note 2) However, functions are not set. Pressing this key will have no effect.

Alarm/Alarm Indicators and Explanations

The 6 basic temperature controller alarms are displayed on the operation display panel with alarm indicators (red LED). Operation stops if an alarm is active, assuring safety. When the source of the problem has been eliminated, the equipment must be restarted.

■ Explanation of Alarms (HRG001/002/005)

Indicator	Alarm	Operation status	Main reason
[ALARM]	Prevention of reverse electrical current to the pump and refrigerator	Stop	The power supply to this unit is incorrect.
	Low level of fluid in tank	Stop	Level switch activated because fluid level in tank fell below LOW.
	Interrupted or abnormal facility water supply ^{Note 1)}	Stop	Pressure switch activated because inadequate heat dissipation caused refrigerant pressure to rise.
	Circulating fluid temperature abnormally high	Stop	Temperature sensor activated because circulating fluid temperature became too high.
	Overload of pump	Stop	Circulation pump overload relay activated.
	Overheating of fan motor ^{Note 2)}	Stop	Fan motor thermostat activated.
	Overload of refrigerator	Stop	Refrigerator overload relay activated.

■ Explanation of Alarms (HRG010/015)

Indicator	Alarm	Operation status	Main reason
^{Note 3)} [ALARM1]	Prevention of reverse electrical current to the pump and refrigerator	Stop	The power supply to this unit is incorrect.
	Low level of fluid in tank	Stop	Level switch activated because fluid level in tank fell below LOW.
	Interrupted or abnormal facility water supply ^{Note 1)}	Stop	Pressure switch activated because inadequate heat dissipation caused refrigerant pressure to rise.
^{Note 4)} [ALARM2]	Circulating fluid temperature abnormally high	Stop	Temperature sensor activated because circulating fluid temperature became too high.
	Overload of pump	Stop	Circulation pump overload relay activated.
^{Note 5)} [ALARM3]	Overheating of fan motor ^{Note 2)}	Stop	Fan motor thermostat activated.
	Overload of refrigerator	Stop	Refrigerator overload relay activated.

Note 1) Only for water-cooled refrigeration (HRG□□□-W)

Note 2) Only for air-cooled refrigeration (HRG□□□-A)

Note 3) ALARM 1 lights up when power supply is turned on but operation has not commenced due to abnormal installation status: incorrect installation or inadequate preparation.

Note 4) ALARM 2 lights up if a water delivery circuit error occurs after operation has begun.

Note 5) ALARM 3 lights up if a refrigeration circuit error occurs after operation has begun.

Contact Input/Output Function

The Thermo-cooler is equipped with terminals that allow remote start/stop, and enable output of an operation signal or abnormal status stop signal. These should be used for synchronizing startup and shutdown with your other equipment, or when adding new patrol lights or buzzers. However, the contact output volume is limited, so please add patrol lights and/or buzzers for special relays (for amplification) if they are necessary.

Item	Specifications				
	HRG001	HRG002	HRG005	HRG010	HRG015
Connector type	M3 terminal block				
Remote operation signal input	Signal type	DC voltage input			
	Input voltage range	24 VDC \pm 5 V			
	Input current	0.5 to 8 mA			
	Terminal number <small>Note</small>	1 (24 VDC), 2 (24 VCOM)		24 (24 VDC), 25 (24 VCOM)	
Alarm stop signal output	Signal type	Non-voltage contact output			
	Contact capacity	250 VAC, 1 A (Resistance load)			
	Terminal number <small>Note</small>	3, 4		28, 29	
Operation signal output	Signal type	Non-voltage contact output			
	Contact capacity	250 VAC, 1 A (Resistance load)			
	Terminal number <small>Note</small>	5, 6		30, 31	
Circuit diagram	<p>Note) For terminal numbers shown in the diagram, please refer to the terminal numbers for each type of signal listed in the table.</p>				

Input/output signal connection location

Remove the front panel and connect a signal cable to the terminal block inside the electrical component enclosure.

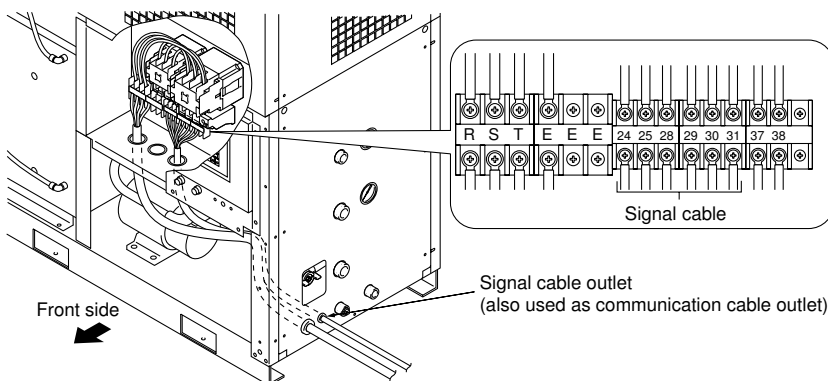

Other Features

- Automatic water supply function (Built-in ball tap)**
 The tank contains a built-in ball tap for water supply valve).
 By installing a water supply connection, you can automatically keep the water level at its rated position (halfway between HI and LOW).
* HRG001 to 005-□□-X034
* HRG010/015 standard specifications
- Modified product with remote operation signal**
 Remote operation is possible with a contact input. No need for DC power supply.
* HRG001 to 015-□□-X071
- Anti-freezing function**
 This function detects the circulating fluid temperature. If the temperature approaches freezing point, e.g. in winter at night, the pump operates automatically and the heat generated by the pump warms the circulating fluid, preventing freezing.
* HRG010/015 standard specifications

Series HRG Options

Note) Options have to be selected when ordering the Thermo-cooler. It is not possible to add them after purchasing the unit.

A Option symbol With Casters

HRG --A
● With casters

The casters allow easy movement when delivering the equipment for installation or when altering the production area. An adjuster may be used instead of a stopper.

Applicable model	HRG001-□□-A	HRG002-□□-A	HRG005-□□-A	HRG010-□-A	HRG015-□-A			
Adjuster height adjustment range (mm)	0 to 10			0 to 15				
Product mass (kg)	75	80	130	125	220	215	245	235
Product height (mm)	1017		1217		1383			

Caster mounting location

Rotating casters with adjusters at the four corners are attached to the caster bases.

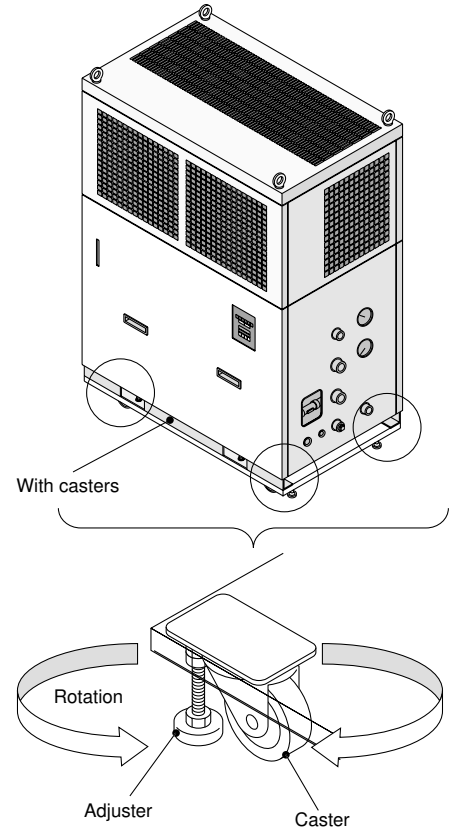

B Option symbol With Ground Fault Circuit Interrupter

HRG --B
● With ground fault circuit interrupter

In the event of a short circuit, overcurrent or overheating, the ground fault circuit interrupter will automatically shut off the power supply. The power supply can be switched on or off easily from the main unit.

Applicable model	HRG001-□□-B	HRG002-□□-B	HRG005-□□-B	HRG010-□-B	HRG015-□-B
Pole number	3				
Rated current sensitivity (mA)	30				
Rated shutdown current (A)	5	10	20	40	60
Short circuit display method	Mechanical button				

Breaker mounting location

Remove the front panel. The breaker is mounted inside the electrical component enclosure.

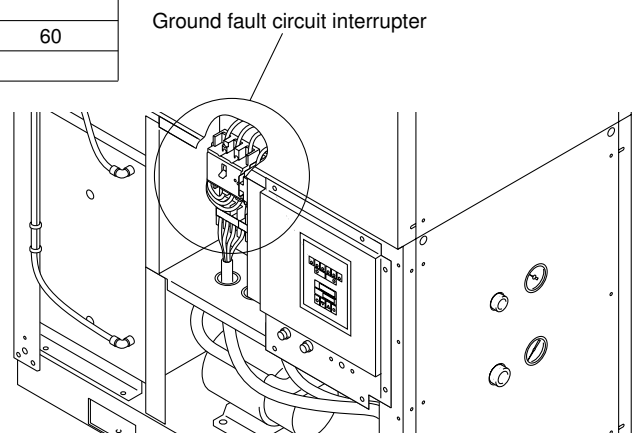

C

Option symbol

With Communications Function (RS-485)

HRG - - **C**

● With communications function (RS-485)

With a host PC programmed in accordance with your manufacturing processor method, the communications function allows you to set (write) or monitor (read) the circulating fluid temperature.

<Writing>

Circulating fluid temperature setting (SV)

<Readout>

Circulating fluid present temperature (PV)

Circulating fluid temperature setting (SV)

Applicable model	HRG001-□□-C	HRG002-□□-C	HRG005-□□-C	HRG010-□-C	HRG015-□-C
Connector no.	7 (TRD+), 8 (TRD-)			37 (TRD+), 38 (TRD-)	
Connector type (on this product side)	M3 terminal block				
Standards	EIA RS-485 compliant				
Protocol	Special protocol: For details, refer to the Communications Specifications document.				
Circuit configuration diagram					

Communication connection location

Remove the front panel, and connect your communication cable to the terminal block mounted inside the electrical component enclosure.

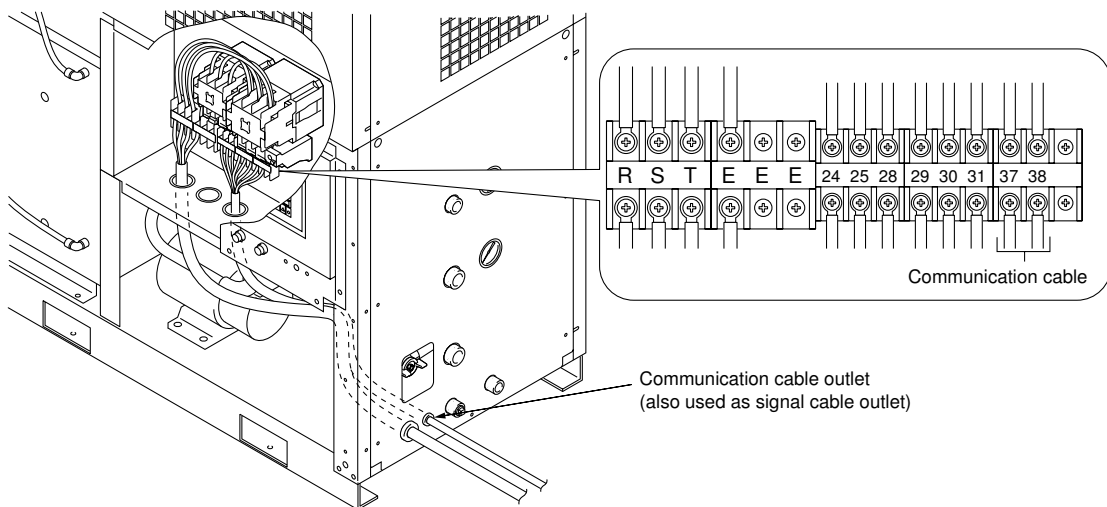





HRG
HRGC
HRZ
HRW
HEC
HEB
HED
Technical Data
Related Products

Series HRG

Optional Accessories

Note) Please order separately.
Necessary to be fitted by customer.

Specifications

Description	Description	Specifications	Applicable Thermo-cooler
Dustproof filter set	 Prevents performance degradation when using air-cooled refrigeration Thermo-coolers in dusty or contaminated environments.	Maximum ambient temperature 40°C	HRG001-A□ to 015-A
By-pass piping set	 Prevents overloading of the pump at low flow rates when the maximum Thermo-cooler operating pressure of 0.5 MPa is exceeded.	Circulating fluid temperature range 5°C to 35°C	HRG001-A□ to 015-A HRG001-W□ to 015-W
Separate power transformer	 Makes it possible to use the equipment with a power supply voltage differing from the standard specifications.	Maximum ambient temperature 40°C (Relative humidity 85% or less)	HRG001-A□ to 015-A HRG001-W□ to 015-W
Foundations bolt set	 Bolts used to affix the Thermo-cooler to the foundation. Easy to use – just drive in the core rod.	Stainless steel	HRG001-A□ to 015-A HRG001-W□ to 015-W
Piping adapter	 Adapter to change the type of screw used in the connection port of the Thermo-cooler.	Copper alloy	HRG001-A□ to 015-A HRG001-W□ to 015-W

How to Order

[Dustproof filter set]

HRG – FL

• **Applicable Thermo-cooler**

Symbol	Applicable Thermo-cooler	Quantity per set
001	HRG001-A□ HRG002-A□	1
005	HRG005-A□	1
010	HRG010-A	1
015	HRG015-A	(Large) 1 (Small) 2

Note) Refer to page 30 for dimensions and page 34 for mounting.

[By-pass piping set]

HRG – BP

• **Applicable Thermo-cooler**

Symbol	Applicable Thermo-cooler	Set pressure (Blow pressure)
001	HRG001-□□ HRG002-□□	0.12 [MPa]
005	HRG005-□□	0.30 [MPa]
010	HRG010-□	0.31 [MPa]
015	HRG015-□	0.32 [MPa]

Note) Refer to page 31 for dimensions and pages 34 and 35 for mounting and flow characteristics.

How to Order

[Separate power transformer]

IDF – TR 

• **Volume**

Symbol	Applicable Thermo-cooler	Volume
1700	HRG001-□□	1.7 kVA
4000	HRG002-□□	4 kVA
7000	HRG005-□□	7 kVA
14000	HRG010-□	14 kVA
18000	HRG015-□	18 kVA

• **Power supply voltage**

Symbol	Inlet voltage	Outlet voltage	Type
5	220 VAC (50 Hz)	200 VAC (50 Hz) 200 to 220 VAC (60 Hz)	3-phase single
	220 to 240 VAC (60 Hz)		
6	380, 400, 415 VAC (50 Hz)		
	380 to 440 VAC (60 Hz)		
7	440, 460 VAC (50 Hz) 440 to 500 VAC (60 Hz)		
8	220, 240, 380, 400, 415, 440 VAC (50/60 Hz)	200 VAC (50/60 Hz)	3-phase double

Note) Refer to page 32 for dimensions.

[Foundations bolt set]

IDF – AB 

• **Size**

Symbol	Applicable Thermo-cooler	Material	Quantity per set
500	HRG001-□□	Stainless steel	4
	HRG002-□□		
	HRG005-□□		
501	HRG010-□		
	HRG015-□		

Note) Refer to page 33 for dimensions.

[Piping adapter]

IDF – AP 

• **Size**

Symbol	Applicable Thermo-cooler	Thread type and port size		Material	Quantity per set
		Male side A	Female side B		
601	HRG001-□□	R 1/2	NPT 1/2	Copper alloy	2
	HRG002-□□				
	HRG005-□□				
	HRG010-□ HRG015-□				
603	HRG010-□ HRG015-□	R 3/4	NPT 3/4		

Note) Refer to page 33 for dimensions. Specify the quantity of units necessary for use with your piping system.

HRG

HRGC

HRZ

HRW

HEC

HEB

HED

Technical Data

Related Products

Series HRG

Dimensions

[Dustproof filter set]

HRG-FL001

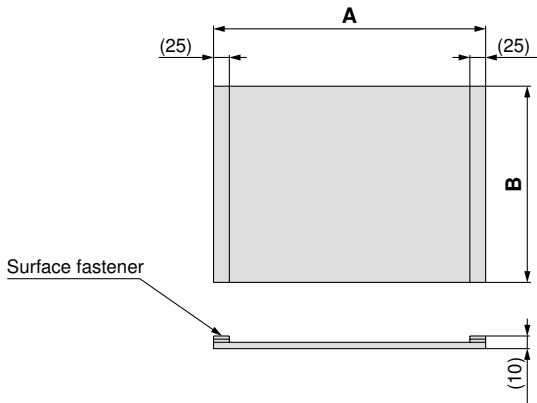

HRG-FL005

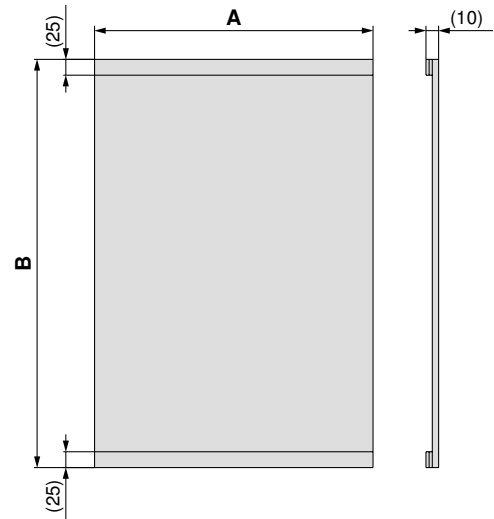

HRG-FL010

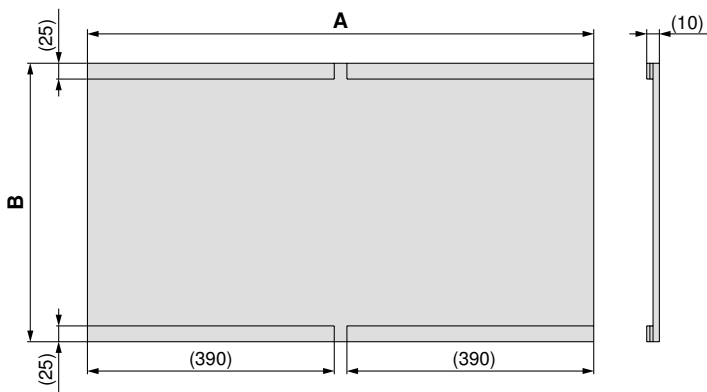

HRG-FL015

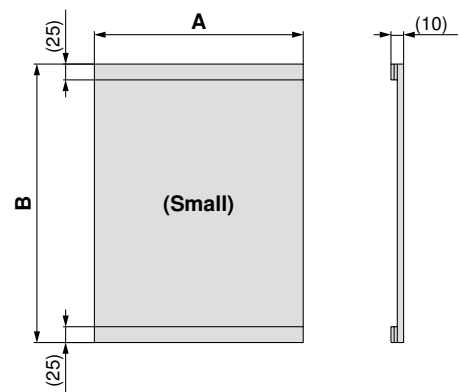
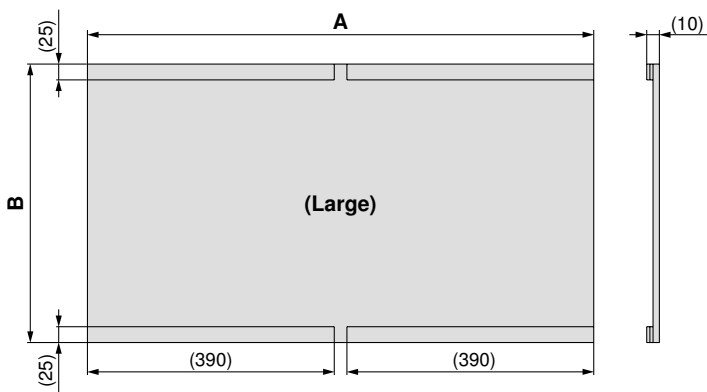

(mm)

Part no.	A	B	C	Quantity per 1 set
HRG-FL001	430	310	10	1
HRG-FL005	440	645	10	1
HRG-FL010	880	440	10	1
HRG-FL015	(Large) 880 (Small) 330	(Large) 440 (Small) 440	(Large) 10 (Small) 10	(Large) 1 (Small) 2

Dimensions

[By-pass piping set]

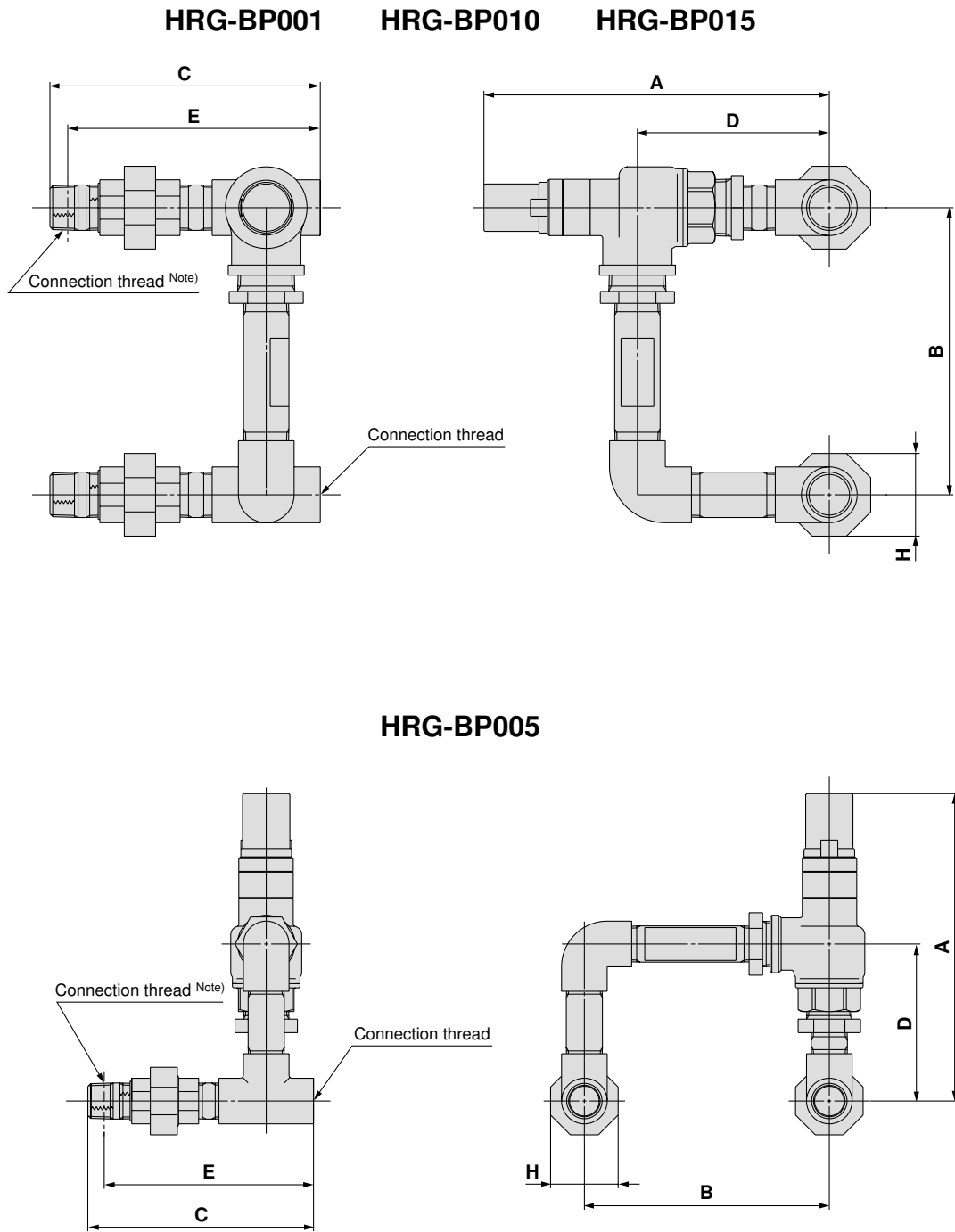

Part no.	Connection thread R, Rc	A	B	C	D	E	H (Width across flats)	Mass (kg)
HRG-BP001	1/2	168	160	120	84	109	40	2
HRG-BP005	1/2	182	145	120	93	109	40	2
HRG-BP010	3/4	206	170	150	114	138	49	2.6
HRG-BP015	3/4	236	170	150	122	138	49	3.2

Note) The connection thread of the nipple comes with PTFE seal tape.

Series HRG

Dimensions

[Separate power transformer]

Specifications

Transformer part no.	Applicable Thermo-cooler	Volume	Type	Inlet voltage	Outlet voltage
IDF-TR1700-5	HRG001-□□	1.7 kVA	3-phase single	220 VAC (50 Hz) 220 to 240 VAC (60 Hz)	200 VAC (50 Hz) 200 to 220 VAC (60 Hz)
IDF-TR1700-6				380, 400, 415 VAC (50 Hz) 380 to 440 VAC (60 Hz)	
IDF-TR1700-7				440, 460 VAC (50 Hz) 440 to 500 VAC (60 Hz)	
IDF-TR4000-5	HRG002-□□	4 kVA		220 VAC (50 Hz) 220 to 240 VAC (60 Hz)	
IDF-TR4000-6				380, 400, 415 VAC (50 Hz) 380 to 440 VAC (60 Hz)	
IDF-TR4000-7				440, 460 VAC (50 Hz) 440 to 500 VAC (60 Hz)	
IDF-TR7000-8	HRG005-□□	7 kVA	3-phase double	220, 240, 380, 400, 415, 440 VAC (50/60 Hz)	200 VAC (50/60 Hz)
IDF-TR14000-8	HRG010-□	14 kVA			
IDF-TR18000-8	HRG015-□	18 kVA			

IDF-TR1700-5

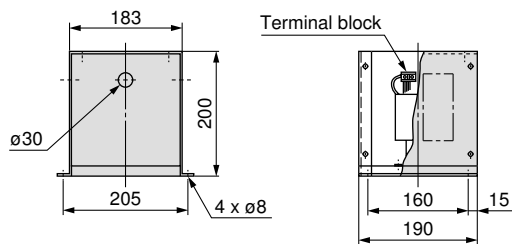

IDF-TR1700-6/7

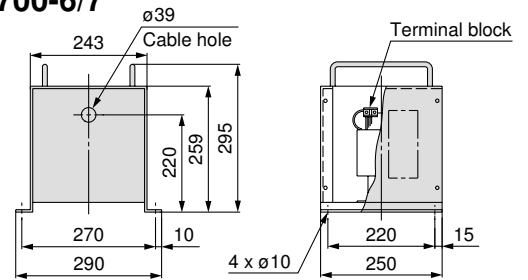

IDF-TR-□-5/6/7

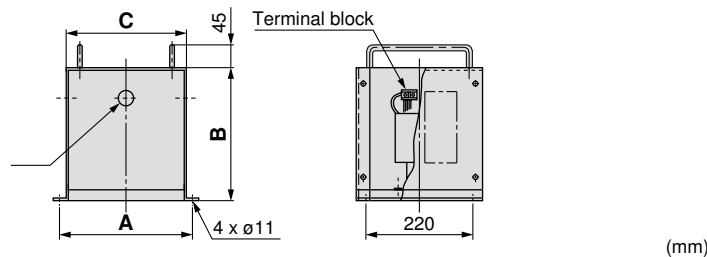

Transformer part no.	A	B	C	Mass (kg)
IDF-TR4000-5	275	259	240	14
IDF-TR4000-6	355	299	320	35
IDF-TR4000-7	355	299	320	42

IDF-TR-□-8



Transformer part no.	A	B	C	D	E	F	G	Mass (kg)
IDF-TR7000-8	360	540	400	260	300	11	30	94
IDF-TR14000-8	400	650	450	300	350	13	40	152
IDF-TR18000-8	400	650	450	300	350	13	40	179

Dimensions

[Foundations bolt set]

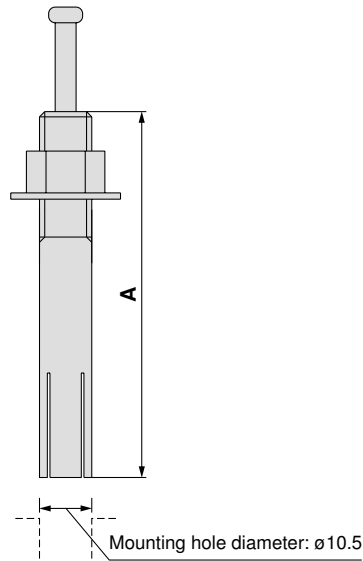

(mm)				
Part no.	Applicable Thermo-cooler	Nominal thread size	A	Quantity per set
IDF-AB500	HRG001-□□	M10	50	4
	HRG002-□□			
	HRG005-□□			
IDF-AB501	HRG010-□		70	4
	HRG015-□			

[Piping adapter]

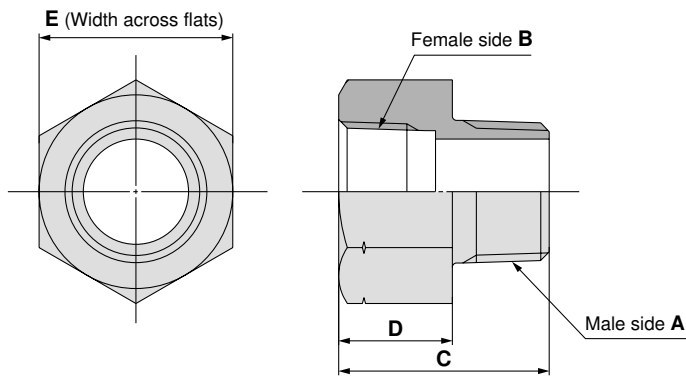

Part no.	Applicable Thermo-cooler	Thread type and port size		C	D	E	Quantity per set
		Male side A	Female side B				
IDF-AP601	HRG001-□□	R 1/2	NPT 1/2	38	23	26	2
	HRG002-□□						
	HRG005-□□						
	HRG010-□						
	HRG015-□						
IDF-AP603	HRG010-□	R 3/4	NPT 3/4	43	23	32	2
	HRG015-□						

HRG
HRGC
HRZ
HRW
HEC
HEB
HED
Technical Data
Related Products

Mounting Example

Note) Please order separately. Necessary to be fitted by customer.

[Dustproof filter set]

- ① This dustproof filter is secured with hook-and-loop tape. This is sewed onto the male side of the surface fastener, and has adhesive tape backing for fixing to the female side.
- ② Remove the paper covering of the adhesive tape and affix the loop tape to the external panel of the ventilation hole on the Thermo-cooler.
- ③ Simply press the hook tape on to the loop tape to mount the dustproof filter.

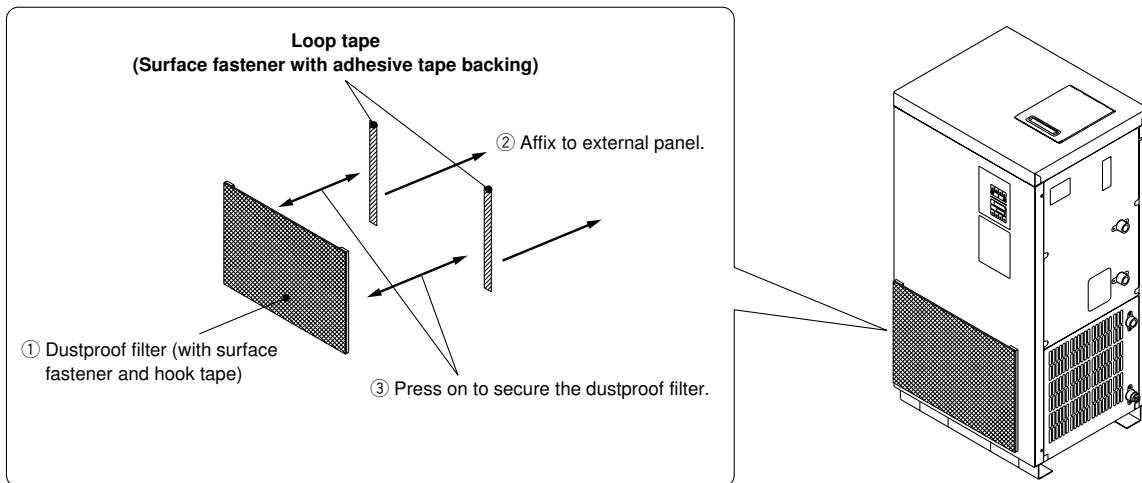

[By-pass piping set]

- ① This set consists of a body with assembly of relief valve and union (female), along with a nipple, union (male) and union seal.
- ② To mount, screw the union (male) and nipple onto the circulating fluid outlet and circulating fluid return inlet of the thermo-cooler.
- ③ Next, place the union seal between the union (male) and union (female) of the body, and gently tighten screw on tentatively (manually), in the appropriate mounting direction for the model used (refer to instruction manual), paying attention to the direction of flow of the body (relief valve).
- ④ Finally, tightly fasten the union (female) of the body to the union (male) tightly. Note)

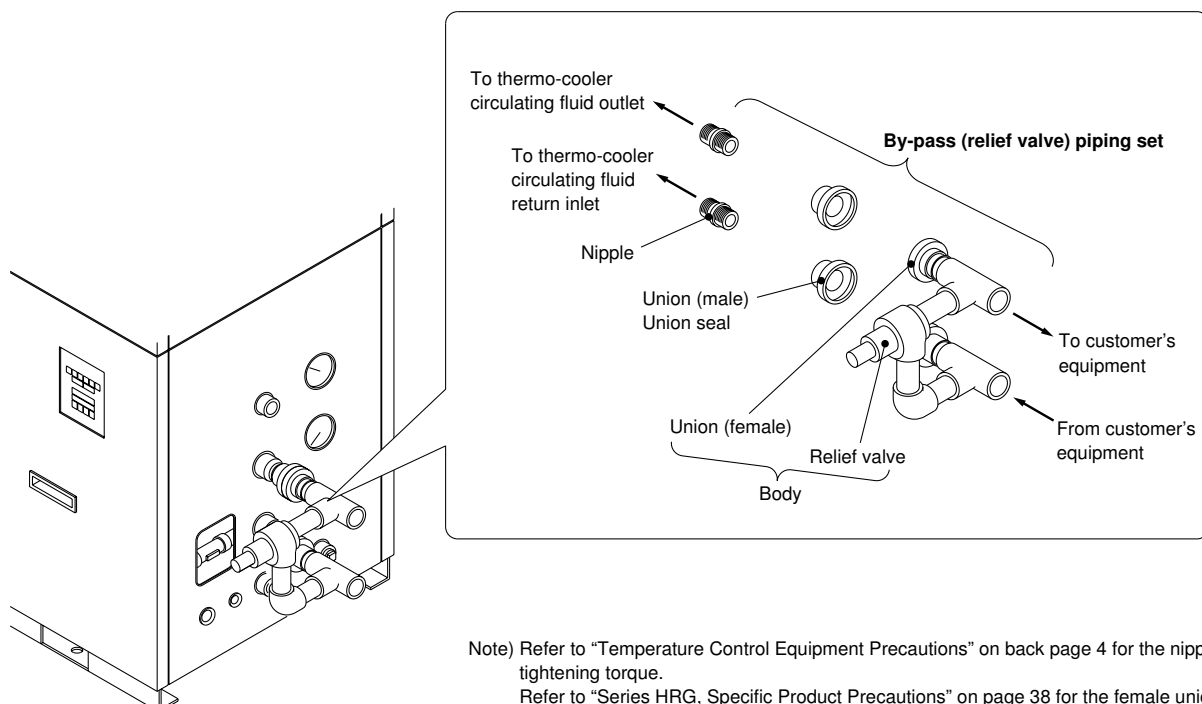

Note) Refer to "Temperature Control Equipment Precautions" on back page 4 for the nipple tightening torque.
Refer to "Series HRG, Specific Product Precautions" on page 38 for the female union tightening torque.

[Pump capacity for each Thermo-cooler after mounting the by-pass piping set]

HRG001-□□ (After mounting HRG-BP001)

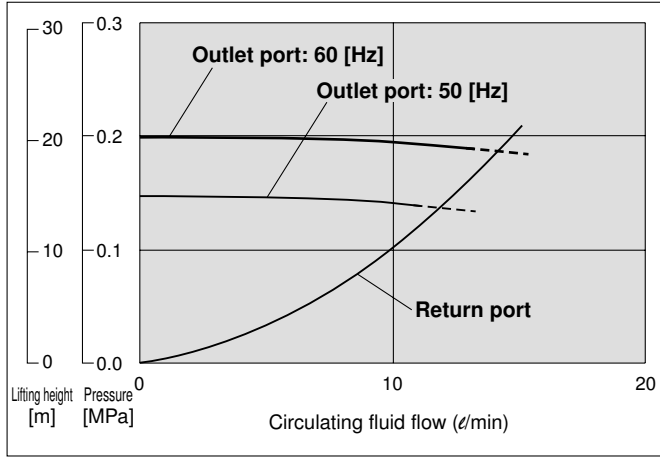

HRG002-□□ (After mounting HRG-BP001)

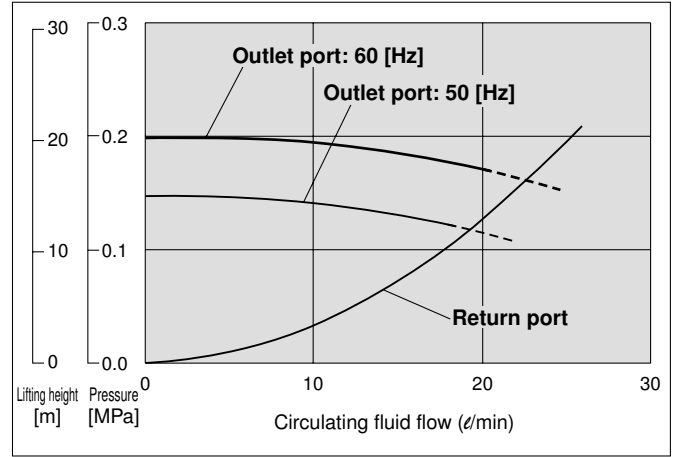

HRG005-□□ (After mounting HRG-BP005)

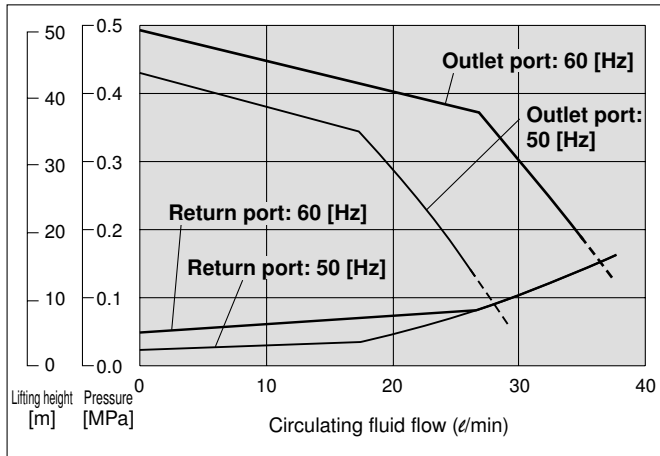

HRG010-□ (After mounting HRG-BP010)

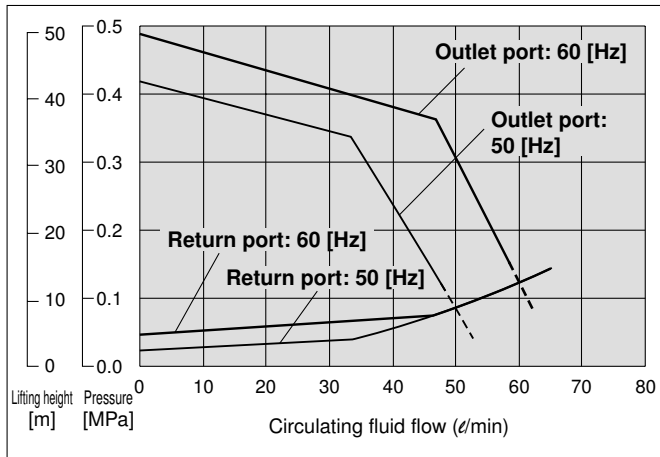

HRG015-□ (After mounting HRG-BP015)

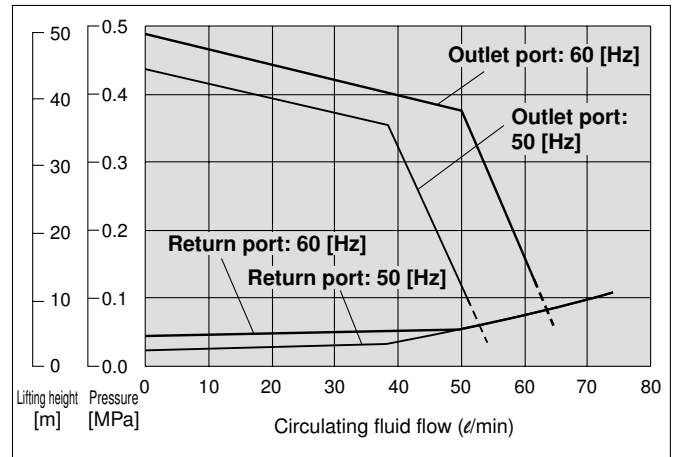

HRG
HRGC
HRZ
HRW
HEC
HEB
HED
Technical Data
Related Products



Series HRG Specific Product Precautions 1

Be sure to read this before handling.

Refer to back pages 1 and 2 for Safety Instructions and back pages 3 to 6 for Temperature Control Equipment Precautions.

Design

Warning

1. This catalog shows the specification of a single unit.

1. Confirm the specification of the single unit (contents of this catalog) and thoroughly consider the adaptability between the customer's system and this unit.
2. Although the protection circuit as a single unit is installed, prepare a drain pan, water leakage sensor, discharge air facility, and emergency stop equipment, depending on the customer's operating condition. Also, the customer is requested to carry out the safety design for the whole system.

2. When attempting to cool areas that are open to the atmosphere (tanks, pipes), plan your piping system accordingly.

When cooling open-air external tanks, arrange the piping so that there are coil pipes for cooling inside the tanks, and to carry back the entire flow volume of circulating fluid that is released.

Selection

Warning

1. Model selection

For selecting a model of Thermo-cooler, it is required to know the heat generation amount of a customer's equipment. Obtain the heat generation amount, referring to the model selection example for the HRG series before selecting a model.

2. Indication of model number

Select the cooling method and temperature stability depending on the customer's application.

Handling

Warning

1. Thoroughly read the operating manual.

Read the operating manual completely before operation, and keep a copy on-site, for future reference.

Operating Environment / Storage Environment

Warning

1. Do not use in the following environment because it will lead to a breakdown.

1. Environment like written in "Temperature Control Equipment Precautions".
2. Locations where spatter will adhere to when welding.
3. Locations where it is likely that the leakage of flammable gas may occur.
4. Locations having a large quantity of dust.
If it is necessary to use the unit in an environment where there is a risk of the fin portion of the air-condenser becoming clogged, please use the dustproof filter set (sold separately).

2. Install in an environment where the unit will not come into direct contact with rain or snow.

(HRG001 to HRG005)

These models are for indoor use only.

Do not install outdoors where rain or snow may fall on them.

(HRG010/015)

These models are built to rainproof enclosure IPx3, but are not completely waterproof to rain, etc. (as with IPx4 or higher).

To prolong the lifespan of this equipment, we recommend installation under an awning or other shelter.

Operating Environment / Storage Environment

Warning

3. Conduct ventilation and cooling to discharge heat.

(Air-cooled refrigeration)

The heat which is cooled down through air-cooled condenser is discharged. When using in a room which is shut tightly, ambient temperature will exceed the specification range stipulated in this catalog, which will activate the safety detector and stop the operation.

In order to avoid this situation, discharge the heat outside of a room by ventilation or cooling facilities.

Circulating Fluid

Caution

1. Avoid oil or other foreign objects entering the circulating fluid.

2. Use ethylene glycol aqueous solution which does not contain additives such as antiseptics.

3. When using ethylene glycol aqueous solution, maintain a maximum concentration of 15%.

Overly high concentrations can overload the pump, and cause safety protection devices to commence operation, stopping the operation of the unit.

Low concentrations, however, can lead to freezing at cold temperatures and cause the thermo-cooler to break down.

4. When using clear water as a circulating fluid, use water that conforms to the appropriate water quality standards.

Use water that conforms to the standards shown in the table below (including water used for dilution of ethylene glycol aqueous solution).

Clear Water (as Circulating Fluid) Quality Standard

The Japan Refrigeration and Air Conditioning Industry Association

JRA GL-02-1994 "Cooling water system – Circulation type – Make-up water"

	Item	Unit	Standard value
Standard item	pH (at 25°C)	—	6.8 to 8.0
	Electrical conductivity (25°C)	[μS/cm]	100* to 300*
	Chloride ion (Cl ⁻)	[mg/L]	50 or less
	Sulfuric acid ion (SO ₄ ²⁻)	[mg/L]	50 or less
	Acid consumption amount (at pH4.8)	[mg/L]	50 or less
	Total hardness	[mg/L]	70 or less
	Calcium hardness (CaCO ₃)	[mg/L]	50 or less
Reference item	Ionic state silica (SiO ₂)	[mg/L]	30 or less
	Iron (Fe)	[mg/L]	0.3 or less
	Copper (Cu)	[mg/L]	0.1 or less
	Sulfide ion (S ₂ ⁻)	[mg/L]	Should not be detected.
	Ammonium ion (NH ₄ ⁺)	[mg/L]	0.1 or less
	Residual chlorine (Cl)	[mg/L]	0.3 or less
	Free carbon (CO ₂)	[mg/L]	4.0 or less

* In the case of [MΩ·cm], it will be 0.003 to 0.01.

5. It is possible to use or supply the unit with deionized water, but it is not possible to maintain specific resistance.

When using deionized water, make sure to supply water with an electrical conductivity of 1 μS/cm or more. (In case of electrical resistivity, it should be 1 MΩ·cm or less.) However, it is not possible to maintain electrolyte concentration, as elements of the parts coming into contact with fluid may dissolve.

(HRG001/002)

1. A magnet pump is used as a circulating pump for the lubricating liquid.

It is particularly impossible to use liquid including metallic powder such as iron powder.



Series HRG Specific Product Precautions 2

Be sure to read this before handling.

Refer to back pages 1 and 2 for Safety Instructions and back pages 3 to 6 for Temperature Control Equipment Precautions.

Transportation / Transfer / Movement

Warning

1. Transportation by forklift (HRG001 to 015)

1. A licensed driver should drive the forklift.
2. The proper place to insert the tines of the forklift differs depending on the model of cooler. Check the operating manual to confirm, and be sure to drive the fork in far enough for it to come out the other side.
3. Be careful not to bump the fork to the cover panel or piping ports.

2. Hanging transportation (HRG005 to 015)

1. Crane manipulation and slinging work should be done by an eligible person.
2. Do not grip the piping on the right side or the handles of the panel.
3. When hanging by the eye bolts, be sure to use a 4-point hanging method. For the hanging angle, use caution regarding the position of the center of gravity and hold it within 60°.

HRG001/002

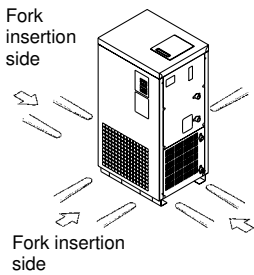

HRG005

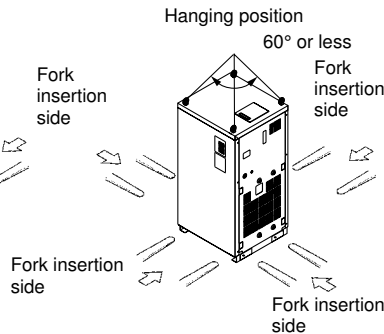

HRG010/015

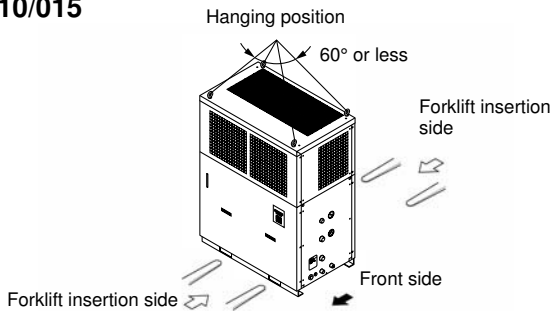

(When using optional casters HRG□□□-□□-**A**)

1. Transporting using casters

1. This product is heavy and should be moved by at least two people.
2. Do not grip the piping port on the right side or the handles of the panel.
3. When transporting using a forklift, be sure not to let it hit the casters or adjusters, and drive the fork all the way through until it comes out the other side.

Mounting / Installation

Warning

1. Do not place heavy objects on top of this proping, or step on it.
The external panel can be deformed and danger can result.

2. Do not directly touch the edge of the external panel when removing and installing it.
It may cause injury. Be sure to wear protective gloves.

(When using optional casters HRG□□□-□□-**A**)

3. Lower the adjuster and do not move.
Be sure to lower all four adjusters to the level of the floor.

Caution

1. Install on a rigid floor which can withstand this product's mass.

2. Secure with bolts, anchor bolts, etc.

Fasteners such as bolts or anchor bolts should be tighten with the recommended torque shown below.

Fixing Threads Tightening Torque

Connection thread	Applicable tightening torque N·m
M5	3
M6	5.2
M8	12.5
M10	24.5
M12	42

(When using optional accessories/dustproof filter set)

1. Use the attached surface fastener (with adhesive tape) to affix the dustproof filter to the panel of the Thermo-cooler.

2. Mounting the filter will create a certain amount of resistance to ventilation that will reduce the volume of airflow.

For this reason, be sure to keep the ambient temperature at 40°C or less.

3. Depending on the installation height of the Thermo-cooler and/or the cooled substrates, circulating fluid may overflow from the tank lid or overflow outlet.

In particular, avoid overflow from the lid of the built-in tank by installing with a height difference of 10 m or less.

Be sure to pipe the overflow outlet to a wastewater collection pit, etc.

HRG

HRGC

HRZ

HRW

HEC

HEB

HED

Technical Data

Related Products



Series HRG Specific Product Precautions 3

Be sure to read this before handling.

Refer to back pages 1 and 2 for Safety Instructions and back pages 3 to 6 for Temperature Control Equipment Precautions.

Piping

Caution

1. Regarding the circulating fluid pipings, consider carefully the suitability for shutoff pressure, temperature and circulating fluid.

If the operating performance is not sufficient, the pipings may burst during operation.

2. For the circulating fluid pipings, use clean pipings which have no dust, piping debris or other foreign objects inside the pipings, and blow with air prior to undertaking any piping works.

If piping debris or other foreign objects remain inside the circulating fluid circuit, it can result in blockage, insufficient cooling or damage to the pump impeller.

3. Select the piping port size which can exceed the rated flow.

For the rated flow, refer to the pump capacity table.

4. When tightening at the circulating fluid inlets and outlets, tank drain port or overflow outlet of this product, use a pipe wrench to clamp the connection ports.

5. For the circulating fluid piping connection, install a drain pan and wastewater collection pit just in case the circulating fluid may leak.

6. While cleaning the inside of the tank, attach a valve to the tank drain outlet to drain the circulating fluid (clear water).

7. This product series consists of circulating fluid temperature controllers with built-in tanks.

Do not install equipment on your system side such as pumps that forcibly return the circulating fluid to the unit. Also, if you attach an external tank that is open to the air, it may become impossible to circulate the circulating fluid. Proceed with caution.

(Water-cooled refrigeration HRG□□□-W□)

1. When tightening at the facility water inlets and outlets of this product, use a pipe wrench to clamp the connection ports.

2. Install by-pass piping.

This product has a built-in water control valve, so when the refrigeration circuit is stopped, facility water does not flow out in order to save energy.

For this reason, by-pass piping is necessary for conducting maintenance of your facility water equipment, so be sure to install it.

(HRG010/015)

1. When tightening at the water supply ports of this product, use a pipe wrench to clamp these ports.

This product has a built-in ball (float) tap. If you attach it to the faucet of a sink, etc. it will automatically supply water to the rated fluid level of the tank (halfway between HIGH and LOW.)

2. Supply water at a pressure of 0.5 MPa or less.

If the water supply pressure is too high, the pipes may burst during use. Proceed with caution.

(When using optional accessories/by-pass piping set)

1. In order to prevent foreign objects from entering during shipment, a polyethylene cap is attached to the inlets and outlets.

Remove these caps before piping.

2. Pay attention to the flow direction of the relief valve.

Refer to the mounting example shown in the separate operating manual for the by-pass piping set when mounting.

3. Tighten to the applicable torque shown in the below table when tightening the cap nut (female) of the union.

Union (female) Tightening Torque

Nominal size	Applicable tightening torque N•m
Rc 1/2	64 to 125
Rc 3/4	106 to 208

Electrical Wiring

Warning

1. Never change the set value of the safety instrument.

If the set value is changed, it will likely cause a breakdown or cause the product to catch on fire.

2. Before wiring, be sure to cut the power supply.

Never perform any job while the product is energized.

3. When connecting the power, confirm the phase sequence (R, S, T) of the three-phase AC power supply.

An incorrect phase sequence will cause the anti-reversal safety protection device to be activated, and the unit will fail to operate. If this occurs, switch the two wires to the correct phase sequence.

4. Secure the cable so that its force, etc. is not applied to the terminal connector parts.

When the connection or attachment is incomplete, it will likely lead to an electrical shock, a fire, etc.

5. Grounding should never be connected to a water line, gas line or lightning rod.

6. Multiple wiring is dangerous because it will lead to heat generation or cause a fire.

Caution

1. Power supply, signal cable and connecting terminal should be prepared by customer.

2. In the event of wiring the signal for operation/stop commands (remote control), use caution regarding the correct polarity (+, -) of 24 VDC.

(When using the HRG□□□-□□-C with optional communications function)

1. Communication cables and adapters should be prepared by customer.

Prepare parts that conform to the connector specifications of your host computer.

2. Pay attention to the polarity (TRD+, TRD-) when connecting communication cables.



Series HRG Specific Product Precautions 4

Be sure to read this before handling.

Refer to back pages 1 and 2 for Safety Instructions and back pages 3 to 6 for Temperature Control Equipment Precautions.

Facility Water Supply

Warning

(Water-cooled refrigeration HRG□□□-W□)

1. Before startup, be sure to open the valve of your facility water equipment.

Prepare before startup, so that facility water can flow when the fitted water control valve (facility water control valve) opens during operation.

2. Supply pressure should be 0.5 MPa or less.

When the supply pressure is high, it will cause water leakage.

3. Be sure to prepare your utilities so that the pressure of the Thermo-cooler facility water outlet is at 0 MPa (atmospheric pressure) or more.

If the facility water outlet pressure becomes negative, the internal facility water piping may collapse, and proper flow control of facility water will be impossible.

Operation

Warning

1. Confirmation before operation

1. The fluid level of a tank should be within the specified range of "HIGH" and "LOW".

When exceeding the specified level, the circulating fluid will overflow.

2. Remove the air.

Conduct a trial operation, looking at the fluid level.

Since the fluid level will go down when the air is removed from a customer's piping system, supply water once again when the fluid level is reduced. When there is no reduction in the fluid level, the job of removing the air is completed.

3. Handling of by-pass valve

At the time this product is shipped from our factory, the by-pass valve is fully open.

Operation with it fully closed will cause the circulating fluid outlet pressure to increase high and it may safely stop in order to prevent the pump's operation from overloading.

When operating for the first time after installation, be sure to operate it with the by-pass valve fully open.

2. Confirmation during operation

1. Adjust the by-pass valve.

Monitor the external piping, pressure gauge, or flow meter mounted on the equipment from the customer's side, in order to adjust the open angle of the by-pass valve, so that the required pressure or flow can be obtained.

2. Confirm the circulating fluid temperature.

The operating temperature range of the circulating fluid is between 5 and 35°C.

When the amount of heat generated from a customer's equipment is greater than the product's capability, the circulating fluid temperature may exceed this range. Use caution regarding this matter.

3. Emergency stop method

• When an abnormality is confirmed, stop the equipment immediately.

After pushing the (OFF) switch, be sure to turn off the power supply breaker.

(When using optional accessories/by-pass piping set)

1. Do not adjust or change the preset pressure.

When persons other than experts carry out adjustments, leakage can occur from the shaft seal of the adjustment screw. Proceed with caution.

Operation

Caution

1. The temperature set value can be written to EEPROM, but only up to approx. 1 million times.

Especially when using communication function, save data with STOR before stoppage, and do not carry out frequent saving (STOR) of temporary setting values.

Operation Restart Time

Caution

1. Wait five minutes or more before restarting operation after it has been stopped. If the operation is restarted within five minutes, the protection circuit may activate and the operation may not start properly.

Protection Circuit

Caution

1. If operating in the below conditions, the protection circuit will activate and an operation may not be performed or will stop.

- Power supply voltage is not within the rated voltage range of $\pm 10\%$.
- The order of the 3-phase power supply, R, S, T is different.
- In case the water level inside the tank is reduced abnormally.
- Facility water is not supplied. (HRG□□□-W)
- Transfer pressure of the circulating fluid is too high.
- Circulating fluid temperature is too high.
- Compared to the cooling capacity, the heat generation amount of a customer's equipment is too high.
- Ambient temperature is too high (40°C or higher)
- Refrigerant pressure is too high.
- Ventilation hole is clogged with dust or dirt. (Especially HRG□□□-A)

Maintenance

Warning

1. Do not operate the switch with wet hands or touch electrical parts. This will lead to an electrical shock.

2. In the event of cleaning, do not splash water directly on this product for cleaning. This will lead to an electrical shock or a fire.

3. When the panel was removed for the purpose of inspection or cleaning, mount the panel after works were done.

If the panel is still open, or running the equipment with the panel removed, it may cause an injury or electric shocks.

4. In the event of cleaning the air-cooled condenser, do not touch the fin directly.

This may lead to injuries.

HRG

HRGC

HRZ

HRW

HEC

HEB

HED

Technical Data

Related Products



Series HRG Specific Product Precautions 5

Be sure to read this before handling.

Refer to back pages 1 and 2 for Safety Instructions and back pages 3 to 6 for Temperature Control Equipment Precautions.

Maintenance

Caution

<Periodical inspection every one month>

(Air-cooled refrigeration HRG□□□-A□)

1. Cleaning the ventilation hole

If the fin portion of the air-condenser becomes clogged with dust or debris, a decline in cooling performance can result.

In order to avoid deforming or damaging the fin, clean it with a long-haired brush or air gun.

(When using optional accessories/dustproof filter set)

1. Clean the dustproof filter.

To prevent dirt or clogging of the dustproof filter from leading to a decline in heat-releasing performance of the air-condenser, clean or wash it regularly.

2. Remove the filter from the Thermo-cooler before cleaning it.

Do not directly splash water on the filter to clean it while it is still attached to the Thermo-cooler.

This can lead to electric shock or fires in the main unit of the Thermo-cooler.

<Periodical inspection every three months>

1. Inspect the circulating fluid.

1. When using clear water or deionized water

- Replacement of clear water or deionized water

Failure to replace the clear water or deionized water can lead to the development of bacteria or algae. Replace it regularly depending on your usage conditions.

- Tank cleaning

Consider whether dirt, slime or foreign objects may be present in the circulating fluid inside the tank, and carry out regular cleanings of the tank.

2. When using ethylene glycol aqueous solution

Use a concentration measurement device to confirm that the concentration does not exceed 15%.

Dilute or add as needed to adjust the concentration.

2. Check the water quality of facility water.

Regarding the water quality standards for facility water, refer to "Temperature Control Equipment Precautions".

<Periodical inspection every six months>

(HRG005-□□, HRG010-□, HRG015-□) ^{Note 1)}

1. Inspect the circulating fluid.

1. Remove the panel and inspect if there is abnormal leakage from the pump's mechanical seal.

2. Leakage amount of a mechanical seal

Leakage of the mechanical seal cannot be completely avoided due to its construction (rotating machine).

Although this amount of leakage is stipulated as 3 (cc/h) or less (reference value) according to the JIS standard, replace the mechanical seal when the amount of leakage is 0.3 (cc/h) or greater.

Also, as a guide for periodically replacement, the operation hours is 6000 to 8000 hours. (normally 1 year) ^{Note 2)}

Note 1) In the case of the HRG001/002, because the pump included in the unit is a magnet pump with no rotating shaft seal, it is not necessary to inspect the mechanical seal (rotating shaft seal).

Note 2) In placing an order of mechanical seal set (service parts), inform us of the complete model number and the production lot number of the product in use.

<Periodical inspection during the winter season>

1. Keep the pump operating.

(HRG001-□□ to HRG005-□□)

- Continue operating the pump repeatedly.

The heat generated by the pump will prevent freezing.

(HRG010-□, HRG015-□)

- Keep the power supply running (POWER light on, RUN light off), and fully open the valves in the circulating fluid piping.

If the circulating fluid temperature falls below 3°C, the pump will start operating automatically. The heat generated by the pump operation will warm up the circulating fluid. When the temperature rises above 5°C, the pump will stop automatically. Consequently, the circulating fluid temperature is kept between 3°C and 5°C to avoid being frozen.

2. Make water-removal arrangements beforehand.

In extremely cold weather conditions, the heat generated by the pump as described above may not be enough to prevent freezing.

If you expect these kind of conditions, remove the circulating fluid (especially clear water or deionized water) beforehand.

3. Consult a professional.

For additional methods to prevent freezing (such as commercially available tape heaters, etc.), consult a professional for advice.

Technical Data CONTENTS

A	Accumulator	P. 193	M	Magnet pump	P. 195
	Adjustment sensitivity (Hysteresis)	P. 197		Mechanical seal pump	P. 194
	Air-cooled condenser	P. 192	N	Non-return valve	P. 195
	Analog communication	P. 199		NRTL (National Recognized Test Laboratories)	P. 199
	ARW width (Anti-Reset Windup width)	P. 197	O	Offset function	P. 197
	Auto-tuning	P. 197		ON/OFF temperature control	P. 197
B	Band width, Temperature upper/lower limit width	P. 197		Overload relay	P. 198
	Breaker	P. 198	P	Particle filter	P. 195
C	Capillary tube	P. 192		Peltier element	P. 193
	Cascade pump	P. 194		Phase reversal relay (Plugging relay)	P. 198
	CE marking	P. 199		PID control	P. 197
	Centrifugal pump	P. 194		Pipe resistance	P. 194
	CFC refrigerant	P. 192		Power supply frequency	P. 198
	Check valve	P. 195		Propylene glycol aqueous solution	P. 196
	Circulating fluid/Constant temperature circulating fluid	P. 196		Protective devices in refrigeration circuits	P. 193
	Clear water	P. 196		PT sensor/Platinum resistance temperature detector	P. 196
	Compressor	P. 192		Pump capacity/Water-supply capacity	P. 193
	Condenser	P. 192		Pump heat input	P. 195
	Cooler	P. 192		PV	P. 196
	Cooling capacity	P. 195		PWM control	P. 197
	Cooling tower	P. 193	R	Refrigerant dryer	P. 192
	CSA standards	P. 199		Refrigerator	P. 192
D	DC canned pump	P. 195		Relay	P. 198
	DC power supply	P. 198		Relief valve	P. 195
	Degree of viscosity	P. 195		RS232C	P. 198
	Deionized water	P. 196		RS485	P. 198
	Density/Specific gravity	P. 195		RTD (Resistance Temperature Detector)	P. 196
	DeviceNet	P. 199	S	Sealing mechanism	P. 194
	DI filter	P. 195		SEMI F47	P. 199
E	Electrical conductivity	P. 196		SEMI S2	P. 199
	Electromagnetic contactor	P. 198		SEMI S8	P. 199
	Electromagnetic switch	P. 198		Signal input/output, I/O	P. 199
	EMO circuit	P. 198		Solenoid valve	P. 195
	Ethylene glycol aqueous solution	P. 196		Solid state relay (SSR)	P. 198
	eti mark	P. 199		Specific heat/Specific heat capacity	P. 195
	ETL mark	P. 199		Specific resistance	P. 195
	Evaporator	P. 192		Specified CFC	P. 192
	Expansion valve	P. 192		SV	P. 196
	External sensor	P. 197	T	Temperature fuse	P. 196
F	Facility water	P. 193		Thermal relay	P. 198
	Flow sensor/Flow switch	P. 195		Thermistor	P. 196
	Fluorinated fluids	P. 196		Thermo couple	P. 196
	Fluorinert™	P. 196		Thermoelectric device	P. 193
	Fundamentals of refrigeration circuits	P. 192		Thermoelectric system	P. 193
G	GALDEN®	P. 196		Thermo-module	P. 193
	Gear pump	P. 194		Thermostat	P. 196
H	Hardware interlock	P. 198		Three-phase power supply	P. 198
	Heat	P. 195		Time division proportional output	P. 197
	Heat load	P. 195		Turbine pump	P. 194
	Hot gas by-pass	P. 193	U	UL standards	P. 199
I	Impedance protection	P. 198	V	Vane pump	P. 194
	Insulation resistance	P. 199		Vortex pump	P. 194
	Insulation withstand voltage	P. 199	W	Water control valve	P. 193
	Inverter control	P. 193		Water-cooled condenser	P. 192
L	Learning control	P. 197			
	Level switch	P. 195			
	Lifting height/Pressure	P. 193			

HRG
HRGC
HRZ
HRW
HEC
HEB
HED
Technical Data
Related Products

Refrigeration Circuits, Peltier Elements, Cooling Sources

● Compressor

A compressor draws in low-pressure chlorofluorocarbon (CFC) refrigerant gas, compresses the gas and then discharges it as a high-pressure, high-temperature gas. Compressors are classified into various types (reciprocating, rotary, screw, etc.) according to the mechanical compression method used.

● Refrigerator

A compressor that compresses a refrigerant gas. These are called refrigerators to distinguish them from machines such as air compressors.

● CFC refrigerant

CFC (chlorofluorocarbon) refrigerants are organic compounds made up of elements including carbon, hydrogen, chlorine and fluorine. They are referred to generically using the DuPont brand name of Freon®.

When CFCs are used as heat-transfer mediums and circulated inside refrigeration circuits, causing heating and cooling during their condensation and evaporation phase changes, the CFCs are referred to as CFC refrigerants.

● Specified CFC

Due to their stability as a chemical substance and their safety with respect to humans, CFCs came to be widely used as industrial materials, particularly refrigerants. However, it was later recognized that when CFCs (and HCFCs (hydrochlorofluorocarbons)) containing chlorine are released into the atmosphere, they rise up into the ozone layer and deplete it. This resulted in the establishment of the Montreal Protocol in 1987, which classified CFCs such as Freon R12 and HCFCs such as Freon R22 as "specified CFCs" and prohibited their manufacture. As a result, their use has now almost completely died out.

Instead of specified CFCs and HCFCs, SMC products now use HFC refrigerants such as R134a and R404A that have an ozone depletion potential (ODP) of zero.

● Fundamentals of refrigeration circuits

In a refrigeration circuit, refrigerant gas injected into the circuit repeatedly travels through a cycle of compression, condensation, expansion and evaporation, creating high-temperature and low-temperature sections in the circuit. The compressor compresses low-pressure refrigerant gas and discharges the gas at a high temperature and pressure level. The hot, pressurized refrigerant gas enters the condenser where it is cooled by the external air or cooling water and condenses to form a high-pressure liquid refrigerant. As the high-pressure liquid refrigerant passes through a constricting mechanism, such as an expansion valve, it rapidly depressurizes and some of the refrigerant evaporates. The release of evaporation heat causes the refrigerant itself to cool so that it becomes a combination of gas and liquid at a low-

temperature and pressure level. In its combined gas-liquid state, the refrigerant enters the evaporator where it continually evaporates while absorbing the heat within the evaporator, thereby cooling the interior of the evaporator. When the refrigerant emerges from the evaporator, it evaporates entirely and becomes a low-pressure refrigerant gas. The low-pressure refrigerant gas is then drawn into the compressor and again becomes a high-temperature, high-pressure gas as the cycle is repeated.

● Condenser

A heat exchanger used to condense high-temperature, high-pressure refrigerant gas. A condenser has the function of releasing heat drawn up by the refrigeration circuit to the outside. Condensers can be air-cooled or water-cooled, depending on the cooling method used.

● Air-cooled condenser

Air-cooled condensers are generally made up of copper tubes through which the refrigerant flows, with numerous thin aluminum fins attached around the outside of the tubes. Outside air is forced over the fins by a device, such as a fan motor, to cool the pipes to the ambient temperature and condense the refrigerant gas.

If an air-cooled condenser is installed inside a building, it can be used to heat the interior of the building since the heat generated by the refrigeration circuit is released as waste heat from the outside of the condenser. The room in which an air-cooled condenser is installed must have adequate ventilation or air-conditioning equipment.

● Water-cooled condenser

A heat exchanger that uses cooling water to cool and condense the coolant. Water-cooled condensers can be used in environments, such as large factories where cooling tower water or the cooling water for an air-conditioning system can be circulated and used.

Depending on their construction, heat exchangers can be double-pipe type, shell-and-tube type or plate type units.

● Refrigerant dryer

In a refrigeration circuit, a refrigerant dryer consists of filters that absorb and remove moisture inside the refrigeration circuit. Refrigerant dryers are normally installed in pipes carrying liquid refrigerant after it emerges from the condenser.

● Expansion valve

A component that creates an expansion in the refrigeration circuit. As the refrigerant passes through this valve, a large pressure loss results, thereby making it possible to create high-pressure and low-pressure segments within the refrigeration circuit.

There are several types of expansion valve, including constant-pressure expansion valves and thermal expansion valves. Such types allow the size of the valve aperture to be adjusted using refrigerant pressure or temperature feedback from an outlet passage.

● Capillary tube

The capillary tubes used in refrigeration circuits are simply small-caliber copper tubes, normally used in the expansion step, that act as a fixed restrictor in the refrigerant passage.

● Evaporator

A heat exchanger used to cool the target substance (e.g., water or air) using the evaporative heat from a low-temperature, low-pressure combined gaseous and liquid refrigerant in the refrigeration circuit.

● Cooler

→ Evaporator

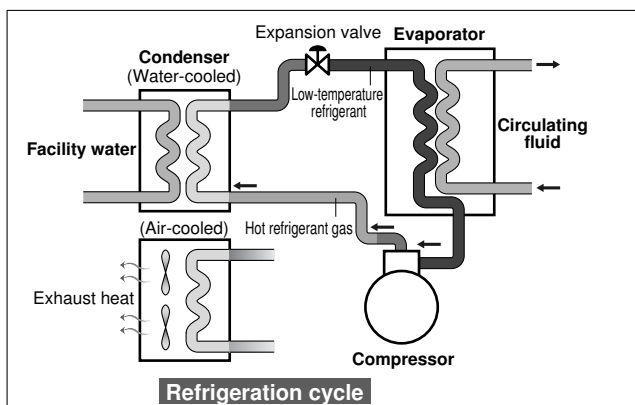

● Accumulator

A tank installed in a refrigeration circuit on the inlet side of the compressor. A compressor is a component designed to compress gas, so a malfunction will occur if any liquid coolant enters the compressor. Installing an accumulator has the function of separating out the coolant gas that is sucked into the compressor and any remaining refrigerant, and of preventing the liquid refrigerant from being sucked into the compressor. The inclusion of an accumulator creates a system that is highly resistant to variability in factors such as the cooling load.

● Hot gas by-pass

A refrigeration circuit sometimes includes a circuit that allows high-temperature, high-pressure refrigerant gas (hot gas) discharged from the compressor to by-pass the condenser so that it reaches the evaporator (on the low-pressure side) without being condensed. This prevents the evaporator temperature (on the low-pressure side) from dropping too far and reduces the risk of liquid refrigerant being drawn into the compressor when the cooling load is low (if there is nothing to refrigerate), thereby ensuring more stable functions of the refrigeration circuit.

This also allows a flow of hot gas to be intentionally directed to the evaporator with the aim of heating the evaporator rather than cooling it.

● Water control valve

A water control valve, installed on the cooling water pipe for a water-cooled condenser, used to adjust the amount of cooling water flowing to the condenser. Water control valves can be either pressure-regulated or temperature-regulated, with the amount of flow regulated using feedback from the condensing pressure or condensing temperature, respectively.

When the cooling water temperature is low, a large flow of cooling water to a water-cooled condenser reduces the condensing pressure and lowers the cooling capacity. In this sort of situation, a water control valve restricts the cooling water flow and maintains the condensing pressure at the desired value. Water control valves also have the function of reducing water consumption by preventing unnecessarily large flows of cooling water.

● Inverter control

In compressors that use an ordinary AC motor, the motor rotation rate is fixed according to the frequency of the AC power supply, with the result that the refrigerant discharge rate is also fixed. Inverter control in a refrigeration circuit is the use of an inverter to vary the compressor rotation rate and thereby control the rate of refrigerant circulation.

This provides means of saving energy by, for example, running the compressor at a slower rate when the cooling load is low.

● Protective devices in refrigeration circuits

In refrigeration circuits, protection must be provided for electrical components such as compressors, and against abnormal refrigerant pressures. Protective measures for compressors (motors) include protective devices such as overload relays (built into the compressor to detect overcurrent and overheating), thermal relays (fitted externally to detect motor overcurrent) and temperature switches.

The devices used to protect against pressure faults include pressure switches, safety valves and rupture disks. However, in refrigeration circuits built into compact devices, the protective devices are often confined to just overload relays, or just thermal relays and pressure switches depending on the anticipated level of risk.

● Facility water

The cooling water flowing through a water-cooled condenser used to expel waste heat generated in the refrigeration circuit

to the outside.

In ordinary factories or buildings, fluids such as cooling tower water or chiller water are used as facility water.

● Cooling tower

A cooling tower is a facility that uses cooling water to expel the waste heat circulated and collected inside a factory or other building into the outside air. Cooling towers are installed in outdoor locations such as on the rooftops of buildings. The cooling water is sprayed down like a shower from the top of the cooling tower and forcibly brought into contact with the outside air by a fan motor. As well as being directly cooled by the temperature of the outside air, the partial evaporation of the cooling water itself draws off evaporation heat, cooling the water further.

Because cooling towers are directly cooled by the outside air, the resulting cooling water temperature varies seasonally depending on the climatic conditions. In addition, the cooling water cannot theoretically be cooled to a temperature any lower than 5°C above the wet-bulb temperature of the outside air.

● Peltier element

An element with a structure made up of alternating layers of flat P-type and N-type semiconductors arrayed in series. When a direct current flows through the element, heat moves from one plate surface to the next, so that one surface is cooled as the opposing surface is heated. This is referred to as the Peltier effect.

By changing the direction of current flow, the direction of heat movement can also be changed, providing a simple means of cooling and heating.

● Thermo-module

→ Peltier element

● Thermoelectric device

→ Peltier element

● Thermoelectric system

A temperature control system that uses a Peltier element to directly cool and heat a liquid, gas or solid.

Heat exchangers suitable for fluids are installed on both sides of the Peltier element, with the fluid to be temperature-controlled on one side of the element while the heat exchanger on the other side is used to dissipate heat.

Fluid Control and Heat-related

● Pump capacity/Water-supply capacity

A pump's water-supply capacity is indicated by the amount of water it can cause to flow at a given pressure (lifting height).

The characteristic curve (pump curve) that indicates the correlation between pressure and flow rate varies depending on the pump type, and thus, the user must check that the type of pump selected is suitable for the intended application.

● Lifting height/Pressure

Lifting height (in meters) is often used instead of pressure to indicate the pump capacity. Lifting height is a numerical value that indicates the capacity of a pump in terms of the height (in meters) to which it can lift a fluid.

The value for pressure is obtained by multiplying the lifting height by the density of the fluid; for example, if a pump capable of generating a lifting height of 10 meters is used to pump water, which has a density of 1 kg/l, the unit pressure generated by the pump is 1 kgf/cm² (0.1 MPa).

If a more dense fluid is used, the pressure is higher even though the lifting height remains the same.

HRG

HRGC

HRZ

HRW

HEC

HEB

HED

Technical
Data

Related
Products

- **Pipe resistance**

When water or another fluid is caused to flow through a passage composed of pipes, valves, etc., the pressure differential generated by friction between the various devices and the fluid is known as “pipe resistance.” A synonymous term is “pressure loss.”

- **Centrifugal pump**

This is one type of pump in which a bladed wheel (impeller) spins inside the pump chamber (casing), applying centrifugal force to the fluid. This force is converted to pressure that discharges the fluid. A large volume of fluid can be pumped, but it is difficult to attain high pressure. When high-pressure is desired, a type fitted with multistage impellers can be used. This is a low-lifting height, high-flow volume pump.

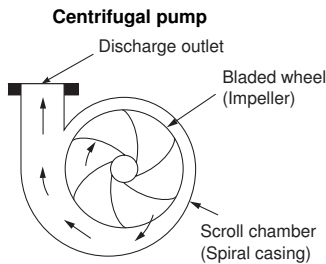

- **Vortex pump**

In this type of pump, a bladed wheel (impeller) spins inside the pump chamber (casing), applying centrifugal force to the fluid. This force is converted to pressure that discharges the fluid. As in a centrifugal pump, the fluid is discharged using centrifugal force, but the impeller has more blades than in a centrifugal pump, and in the pump chamber (casing), the aperture (clearance) is set more narrowly, allowing for a higher discharge pressure. The pressure and flow characteristics attained are somewhere between that of a centrifugal pump and a vane pump. This is a mid-lifting height, mid-flow volume pump.

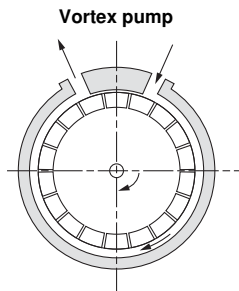

- **Turbine pump**

→ Vortex pump

- **Cascade pump**

→ Turbine pump

- **Vane pump**

In this type of pump, vanes set in a rotor inside the pump chamber brush against the inside walls of the chamber as they rotate, pushing out and discharging the fluid that is surrounded by the vanes, rotor and pump chamber walls. This is a type of PD (positive displacement) pump. This is a high-lifting height, low-flow volume pump.

The vanes slide against the interior walls of the pump chamber, generating abrasion powder. In addition, this type of pump is susceptible to entry of foreign objects such as outside debris, etc.

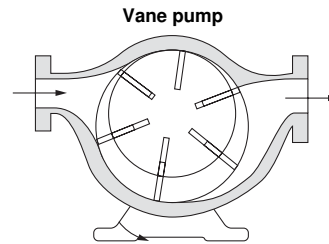

- **Gear pump**

Like the vane pump, this is a type of PD (positive displacement) pump, in which a pair of gears meshes with one another and rotates, pushing the fluid through the gap between them and discharging it.

This is a high-lifting height, low-flow volume pump.

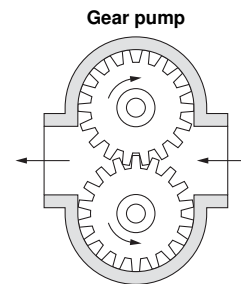

- **Sealing mechanism**

The bladed wheel (impeller) in the pump chamber through which the fluid passes is linked to the shaft of the external electric motor, and the rotation of the impeller discharges the fluid. As water or other fluids seeping through the motor shaft and reaching the electric motor can cause short circuits and other damage, it is necessary to have a mechanism sealing the pump chamber off from the shaft. This is known as a “sealing mechanism.”

There are mechanical seal types, magnet coupling types and others.

- **Mechanical seal pump**

This is a general terms for pumps that use mechanical seals for the sealing mechanism.

The rotating seal mounted on the motor shaft side and the fixed seal mounted on the pump chamber side rotate, and their surfaces touch one another, sealing off the fluid. As a result, there is a slight, external leakage of fluid. The volume of leakage increases over time, so it is necessary to replace the seal portions regularly.

This type can be used for applications where the motor shaft and impeller are directly linked and there is high-shaft power.

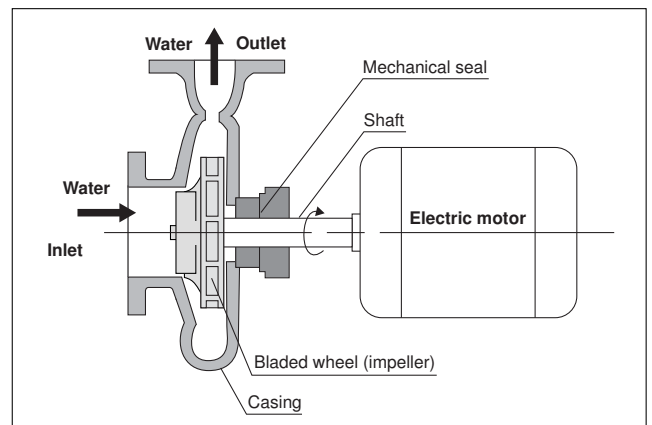

- **Magnet pump**

This is a general term for pumps that use magnetic coupling for the sealing mechanism.

Using magnetism to couple the rotor on the inside of the pump chamber to the permanent magnet mounted on the motor shaft side, with the pump chamber wall between them, the rotation is conveyed to the rotor inside the pump chamber. Since the pump chamber can be completely separated, pump chamber can be completely sealed off, so there is absolutely no external leakage.

Since a large magnet coupling is needed, this type of pump is more difficult to make in small sizes than the mechanical seal type, and the cost is also higher.

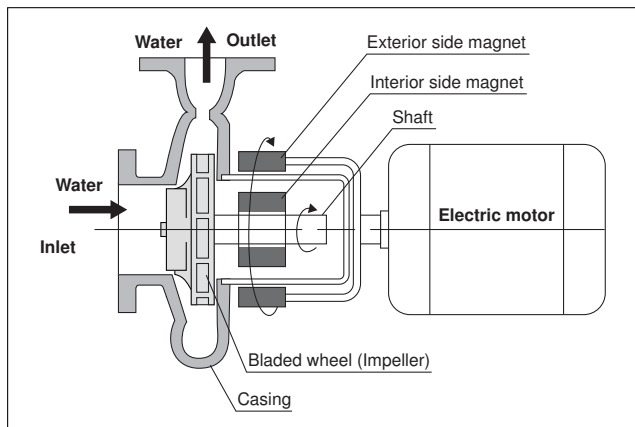

- **DC canned pump**

A pump with a seal-less construction combining the motor and the pump in one. It can be made in compact sizes with absolutely no external leakage of fluid. A DC brushless motor is used.

- **Pump heat input**

The volume of heat applied to the circulation loop, generated by the operation of the pump. When calculating the overall volume of heat applied to the circulation loop, it is necessary to consider the volume of heat generated by the pump, along with that of the object being cooled.

The pump converts the electrical power entering the motor into the kinetic energy of the fluid, which causes the fluid to circulate. This kinetic energy is reduced as a result of undergoing pressure loss inside the piping, and eventually the entirety of the kinetic energy is released into the circulating fluid as heat.

While there are differences depending on the type of pump, for rough calculations, the nominal heat emitted from the pump can be treated as the pump heat input.

- **Solenoid valve**

A component that switches the flow of fluid from ON to OFF, or changes the direction by moving the plunger (iron core) using the force of electromagnetism.

- **Relief valve**

When the inlet pressure exceeds a set level, this valve opens to release the outlet pressure.

- **Flow sensor/Flow switch**

These components monitor the flow rate of the fluid. The flow sensor measures the flow rate linearly. The flow switch only has the function of commencing operation when the flow rate reaches a certain level, and does not perform measurement of the flow volume.

- **Particle filter**

A filter that removes debris and other particles.

- **Check valve**

A check valve is a device that prevents reverse flow of the fluid, keeping it flowing in one direction only.

- **Non-return valve**

→ Check valve

- **Level switch**

A switch that detects the fluid level inside the liquid tank. There are many different types, but the most common type employs a floating buoy, which causes a lead switch (magnetic switch) to turn ON and OFF.

- **DI filter**

A filter that is filled with ion exchange resin used to remove leftover ions from the water. DI stands for “deionized,” while “DI water” is deionized water, or water with its ions removed.

Fluid Properties, Materials, Physical Values

- **Density, specific gravity**

The mass per unit of volume, measured in units of [kg/m³]. Specific gravity is the ratio of the density of a given substance to the density of water, and is a dimensionless quantity. When expressing this quantity within the CGS system of units, density and specific gravity have the same value.

- **Degree of viscosity**

Thickness of a fluid. The units used to express absolute degree of viscosity are [Pa·s] units, but it is often expressed within the CGS system of units with [P] (Poise).

$$1 [\text{Pa}\cdot\text{s}] = 10 [\text{P}]$$

The value obtained by dividing absolute degree of viscosity by density is called the kinetic viscosity. This can be measured in [m²/s] units, but in general, [St] (Stokes) are used.

$$1 [\text{St}] = 0.0001 [\text{m}^2/\text{s}]$$

- **Specific heat, specific heat capacity**

The heat energy required to increase the temperature of an object by a certain temperature interval, under specific pressure and volume conditions.

$$\text{The specific heat of water: } 1 [\text{cal}/\text{g}\cdot\text{K}] = 4.184 \times 10^3 [\text{J}/\text{kg}\cdot\text{K}]$$

- **Cooling capacity**

The volume of heat (heat energy) that temperature control equipment can absorb (cool) per unit of time, at an arbitrary temperature.

- **Heat load**

→ Cooling capacity

- **Heat**

Terms such as heat, heat load, cooling capacity, etc., that are used in this catalog, indicate quantities of heat that can be absorbed or radiated per unit of time. As a result, the units employed are [W] = [J/s] (work rate) or [kcal/hr].

$$1 \text{ kW} = 860 \text{ kcal/hr}$$

- **Specific resistance**

A value indicating the electrical insulating properties of a liquid, and the unit used is [Ω·cm]. When expressing the specific resistance of deionized water, it is sometimes called “DI level.” At 25°C, the specific resistance of theoretically 100% deionized water is 18.3 [MΩ·cm].

HRG

HRGC

HRZ

HRW

HEC

HEB

HED

Technical
Data

Related
Products

● Electrical conductivity

A value indicating the ease with which electricity passes through a liquid, and is inversely proportional to the specific resistance. The unit used is [S/m], incorporating [S] (Siemens), the opposite of [Ω] (resistance).

At 25°C, the electrical conductivity of theoretically 100% deionized water is 0.055 [μ S/m].

● Clear water

Water that has been filtered and distilled and any impurities eliminated. It is also known as purified water.

● Deionized water

Water that has had any impurities or ion elements removed. It is obtained by removing ion elements with ion exchange resin, after filtering out impurities with a particle filter. Its theoretical specific resistance has a limit of 18.3 [$M\Omega\cdot$ cm], but it is impossible to actually attain this value. As a general rule, water with a specific resistance of 1 to 10 $M\Omega\cdot$ cm is referred to as deionized water.

● Ethylene glycol aqueous solution

Ethylene glycol is a type of alcohol, and adding it to water causes the freezing point of the water to drop. It is a major ingredient in antifreeze for automobiles. At a concentration of 60%, the freezing point drops to -40°C or lower, but the viscosity increases as the temperature drops, so taking fluidity into account, it is practical to consider about -20°C as the minimum temperature.

By adding ethylene glycol to deionized water, it is possible to raise the fluid's specific resistance, so it can be used for applications where circulating fluid with high insulating properties is desired.

● Propylene glycol aqueous solution

Propylene glycol is a type of alcohol, and adding it to water causes the freezing point of water to drop. Like ethylene glycol, it is a major ingredient in antifreeze for automobiles.

It has lubricating properties, and is characteristically non-volatile.

● Fluorinated fluids

Inert fluids in the fluorine series. There are many types, including perfluoropolyether (PFPE), perfluorocarbon (PFC), hydrofluoropolyether (HFPE), and hydrofluoroether (HFE), but they share the characteristic of high electrical insulation properties, and grades can be selected with appropriate fluidity even at low temperatures, such as -100°C, and high temperatures, such as 200°C and above.

They are chemically inert and non-poisonous.

Products are sold on the market, such as Fluorinert, made by 3M, and GALDEN, made by Solvay Solexis.

● GALDEN®

The product name of a fluorinated fluid manufactured by Solvay Solexis. It is a perfluoropolyether with a high polymer compound, and various grades can be selected with differing temperature ranges and viscosity ranges depending on the degree of polymerization.

● Fluorinert™

The product name of a fluorinated fluid manufactured by 3M. Its basic structure is a perfluorocarbon, but it has a wide variety of chemical structures, and various grades can be selected with differing temperature and viscosity ranges.

● Circulating fluid, constant temperature circulating fluid

Fluid that circulates among the customer's equipment, with temperature controlled by a chiller.

Taking freezing temperature, boiling point, electrical insulation properties and so on into consideration, clear water, deionized water, ethylene glycol aqueous solution, fluorinated fluids, etc., can be selected depending on the application.

Temperature Measurement and Control

● PT sensor, platinum resistance temperature detector

A type of temperature sensor taking advantage of the properties of platinum (Pt), which has an electrical resistance that increases in proportion to the temperature. A sensor with the specification Pt 100 Ω has a resistance of 100 Ω at 0°C. As the resistance value is relatively small, and the sensor is easily influenced by the resistance value of the conductive wires, an input circuit is generally used which cancels out the resistance value of the conductive wires, by using, for instance, 3-wire or 4-wire wiring configurations and long conductive wires.

● RTD (Resistance Temperature Detector)

→ PT sensor

● Thermo couple

This is created by forming a loop, connecting the ends of two wires made of two different metals, and by keeping the two wires at separate temperatures at the connecting point. Thermoelectric power is generated according to this temperature differential (the Seebeck effect).

As a sensor, by keeping the end of one wire at a standard temperature and measuring the thermoelectric power generated, it can determine the temperature of the other wire terminal. A thermo couple is a sensor employing this principle.

● Thermistor

A temperature sensor employing a semiconductor with electrical resistance that changes in accordance with the temperature. There are two types,

PTC: positive temperature coefficient (a type for which the resistance increases as the temperature rises)

NTC: negative temperature coefficient (a type for which the resistance decreases as the temperature rises.)

The resistance value is generally large, amounting to several $M\Omega$, and there is little influence from the resistance of the conductive wires, so a 2-wire configuration is generally used.

● Thermostat

A switch that turns ON or OFF when it reaches a certain set temperature. Most thermostats are bimetallic.

They are sometimes used for direct temperature control, such as switching a heater ON or OFF, but are also used often for safety circuits which switch OFF when the temperature becomes abnormally high.

The switch can be returned to its original position either automatically or manually.

● Temperature fuse

A fuse in which an internal metal wire melts, breaking the circuit when exposed to a temperature exceeding the set temperature. When this kind of fuse blows, it cannot be reset and must be replaced.

● PV

PV: Process Value. In temperature control equipment, this indicates the current temperature measured by the temperature sensor.

● SV

SV: Set Value. In temperature control equipment, this indicates the target value (set value) for performing temperature control.

- **ON/OFF temperature control**

A control method for adjusting temperature by turning temperature control output ON or OFF relative to the set temperature. When the temperature is above (below) the set temperature, output of the refrigerator (heater) is turned ON, and when the temperature is below (above) the set temperature, output is turned OFF.

Since there are only two operating rates relative to the set temperature, 0% or 100%, this is also called 2-position control.

- **Adjustment sensitivity (Hysteresis)**

When the PV is extremely close to the SV in ON/OFF control, there may be "chattering" where the temperature control output repeatedly turns ON/OFF with small temperature variations, and this may have an adverse impact on output relays and connected equipment. To prevent this, spacing is provided between ON and OFF operation to stabilize control. This operation spacing is called adjustment sensitivity (hysteresis).

For example, if the cooling output ON point (SV) is set to 20.0°C and hysteresis is set to 1.0°C, then cooling output will go OFF when temperature drops to 19.0°C, and go ON when temperature rises to 20.0°C.

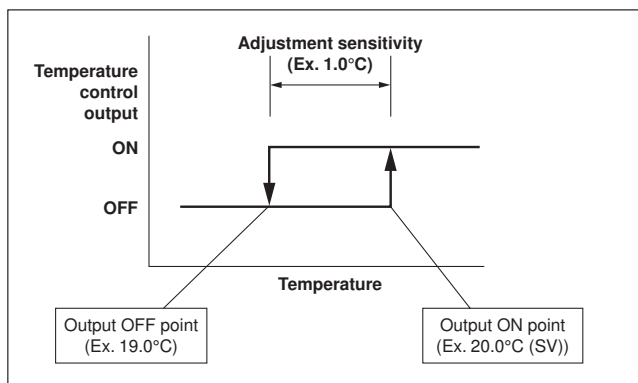

- **PID control**

A control method for producing temperature control output by comparing the temperature difference between the input value from the temperature sensor (PV) and the set temperature (SV), and using a combination of P (Proportional) operation, I (Integral) operation and D (Derivative) operation. Output is linearly variable from 0 to 100%, and this enables smooth temperature control with no temperature wavering.

P (Proportional) operation: Operation where the amount of output is varied from 0 to 100% in proportion to the deviation between PV and SV (temperature difference). The range of temperatures for performing proportional operation (proportional band) must be input as a parameter.

I (Integral) operation: Operation where the temperature discrepancy is corrected by adjusting the amount of output relative to the time that deviation between PV and SV has continued. Since the amount of output is determined in response to the time that deviation continues, the integral time must be input as a parameter.

D (Derivative) operation: Operation where output is produced in accordance with the derivative (speed of change) of the temperature deviation. This is used to quickly correct sudden temperature variations when there is a sudden change in the ambient environment or load. The derivative time is input as a

parameter, and the longer the derivative time, the stronger the correction output that is produced.

- **ARW width (Anti-Reset Windup width)**

Range of integral operation used for PID control. This value is used to designate the range for calculating the integral term, to suppress buildup of the integral component.

- **Auto-tuning**

In PID control, P, I, D and each parameter must be optimally set for the balance of the heat capacity of all parts where the circulation loop is connected. Auto-tuning refers to a function for automatically determining the setting of those parameters. SMC's temperature control equipment is shipped with PID parameters set at factory shipment to the greatest common factor for the various use conditions. However, if those parameter settings are likely to be unsuitable for the actual operating environment, some models provide a function which can automatically set parameters by using auto-tuning.

- **Time division proportional output**

When controlling output of a heater or other device via a relay or SSR, this method of operation makes the ratio of ON time to OFF time proportional to the control output over a fixed time (0.2 to 1.0 sec) in accordance with a previously set time cycle.

For example, if the control cycle is 1.0 sec, and the control output is 70%, then the ON time will be 0.7 sec and the OFF time 0.3 sec.

- **PWM control**

→ Time division control

- **Offset function**

Function for shifting the target temperature for actual temperature control from SV by adding or subtracting a separately set offset value (+ or - a certain number of °C) to or from the set temperature (SV).

For example, if the temperature upon arrival at the object of temperature control is shifted higher (or lower) relative to the temperature discharged from the chiller because a certain amount of heat input is received from piping due to the effects of ambient temperature, this offset value is set to correct that effect.

- **Learning control**

A function for automatically calculating and setting the offset value (correction value for the set temperature).

A temperature sensor (external sensor) is provided near the object to be temperature controlled, and those signals are input to the chiller. The offset value is automatically calculated from the deviation between the discharged temperature and the external sensor.

- **External sensor**

Temperature sensor mounted to the outside of temperature control equipment and used for learning control etc.

- **Band width, Temperature upper/lower limit width**

Temperature range for outputting alarms etc., when PV deviates by more than a fixed temperature from the set temperature (SV).

HRG

HRGC

HRZ

HRW

HEC

HEB

HED

Technical Data

Related Products

Power Supply, Electrical Equipment

● Power supply frequency

There are two frequencies for commercial AC power: 50 Hz and 60 Hz. The AC motors installed in temperature control equipment turn at a rotation speed corresponding to the power supply frequency. When operating with a 60 Hz power supply, the rotation speed is generally 10% faster than with 50 Hz. In the case of a pump, the flow rate and pressure increase, and in the case of a compressor in a refrigeration circuit, the cooling capacity increases. Current consumption also increases in the same way.

In the case of a resistance load, such as a DC pump or heater, performance does not depend on the frequency.

● Three-phase power supply

With three-line AC current or AC voltage, the phases of the lines are shifted by 120°.

The current values of each line are $1/\sqrt{3}$ smaller than single phase with the same level of transmitted power, so thinner wires can be used. There is also the advantage that a rotating magnetic field can be easily produced. (It is possible to use a 3-phase motor with a simple structure.)

A 3-phase power supply is used for equipment with high output.

● Breaker

A device which protects load circuits and wires by breaking the circuit when an abnormal current flows in an outlet circuit due to problems such as overload or shorting. Depending on the application, a breaker may be called a motor breaker, circuit protector or other names. Ground fault circuit interrupters monitor both current in the main circuit and leakage current, and break the circuit if leakage current is too high.

● Relay

A switch which turns a mechanical contact ON/OFF with the power of an electromagnet (solenoid). This makes it possible to turn ON/OFF the high power of the contact with the low power needed to drive the electromagnet only, and thus relays are used for amplification. They are also frequently used as logic elements in sequence circuits.

● Electromagnetic contactor

An electric device for turning power circuits ON/OFF to start and stop power equipment (e.g. motors, heaters). Just like a relay, these devices open or close a mechanical contact with the power of a solenoid. The principle of operation is the same as a relay, but a contactor is designed for high-voltage and large current.

● Thermal relay

A circuit protection device incorporated into the power input circuit of a motor to provide output when motor overcurrent is detected. It is comprised of a heater which heats up in response to current, and a bimetal which opens and closes a contact in response to that heat. Since the thermal relay itself cannot open and close a high capacity power circuit, the main circuit for a motor or other device is broken by incorporating a control circuit with an electromagnetic contactor or relay.

● Electromagnetic switch

A device integrating an electromagnetic contactor with a thermal relay.

● Overload relay

This has the same structure as a thermal relay, and is used for the same purpose. Overload relays built into the compressors of small refrigeration circuits are installed on the wall of the compressor, and are actuated not by heat due to overcurrent but by the temperature of the compressor itself. In many small

compressors, the main circuit is directly broken by the overload relay.

● Impedance protection

A type of motor protection generally used for small AC fan motors and other small motors.

The motor is constructed so that it will not rise above a certain temperature, even when locked for some reason, due to the inherent impedance (AC resistance) of the motor coil itself. Therefore, the motor itself is protected against burnout, even though no thermal relay or other protective device is installed.

● Solid state relay (SSR)

A relay which enables switching of high power using low power by using a thyristor or other semiconductor element. In comparison with an electromagnetic relay, this type has no mechanical moving parts, and thus is capable of high-speed switching. SSRs are compact, and have a long service life.

However, this does not mean that contacts are physically isolated. The fact that there is some leakage current even when the device is OFF must be taken into account.

● Phase reversal relay (Plugging relay)

A switch which monitors the phase sequence of a 3-phase main power supply, and issues a warning if anything is abnormal.

When driving a 3-phase motor with a 3-phase power supply, the motor will turn backwards if the phase sequence of wiring is wrong. This relay is installed to prevent such reverse rotation. These relays are also called plugging relays.

● DC power supply

A device which produces DC power from commercial AC power. DC power is for CPUs inside equipment and other control circuits. Peltier elements for Peltier circulators, thermoelectric baths and other equipment are driven with DC power, so they have a high-capacity DC power supply built-in.

● EMO circuit

An EMO (EMergency Off) circuit is an electrical circuit provided to shut off all power and ensure safe conditions when an emergency stop button (EMO button) is pressed in an emergency.

● Hardware interlock

This is an equipment control circuit for shutting off power in case of trouble. The circuit is logically configured using only relays and other hardware, and does not use software running on the CPU.

● RS232C

A standard for serial communication. This is the communication standard when connecting a PC with an acoustic coupler or modem, and is used for one-to-one communication between PCs.

Since RS232C itself only roughly stipulates the use of wiring systems and other hardware, detailed hardware specifications and software protocols are determined independently by each equipment manufacturer.

● RS485

A standard for serial communication. Only one-to-one communication between devices can be done with RS232C, but with RS485 it is possible to communicate simultaneously with multiple devices by wiring them in a chained, multidrop fashion, and providing addresses via software.

Since RS485 itself only roughly stipulates the use of wiring systems and other hardware, detailed hardware specifications and software protocols are determined independently by each equipment manufacturer. Actual detailed protocols are determined independently by each equipment manufacturer.

- **DeviceNet**

A standard for serial communication.
An open network owned by ODVA (Open DeviceNet Vendor Association Inc.), a non-profit organization headquartered in the US. This is a field network standard covering a wide scope, from the sensor level to the device level.

- **Analog communication**

A method of communicating with external devices using voltage output such as 0 to 10 V. This enables output of PV (measured temperature etc.) and reception of values like SV (set temperature).

- **Signal input/output, I/O**

Input/Output signals such as alarm signal, or operation signals. Since there are various communication methods depending on the equipment model, such as relay output and open collector output, communication specifications must be checked before wiring.

- **Insulation withstand voltage**

Electric potential difference where an insulator material will not be destroyed. In withstand voltage testing at product shipment from the factory, a high AC voltage of 1.5 kV (varies depending on the model) is applied between the electric circuit conductor and the chassis (grounded). Then it is checked that there is no flow of leakage current above the reference value.

- **Insulation resistance**

Electrical resistance between the conductor inside the device and the chassis (grounded). In insulation resistance testing at product shipment from the factory, it is checked that the resistance value with a measured DC voltage of 500 V (or 250 V) is at or above the reference value (a value such as 1 MΩ; varies depending on the model).

- **eti mark**

eti (Electro-Test Inc.) is an NRTL, and issues the eti mark. This mark demonstrates compliance with UL standards.

- **ETL mark**

Intertek ETL SEMKO is an NRTL, and issues the ETL mark. This mark demonstrates compliance with UL standards.

- **SEMI S2**

SEMI is an international industry association of companies producing equipment and materials for the manufacture of semiconductors and flat panel displays. It has established its own standards as safety guidelines for the design of semiconductor manufacturing equipment.

SEMI S2 requirements relate to the work environment, health and safety for products used in semiconductor manufacturing, and cover chemical, radiation, electrical, physical, mechanical, environmental, fire, earthquake, emissions and ergonomics, as well as quality, documentation and manuals etc. Many semiconductor manufacturers require that equipment operating in their plants comply with SEMI S2.

- **SEMI S8**

SEMI S8 is a guideline on ergonomics which is more detailed than the ergonomic requirements in Section 14 of SEMI S2.

- **SEMI F47**

SEMI F47 is a SEMI standard which stipulates guidelines regarding voltage sag immunity. Semiconductor manufacturers require this standard for temperature control equipment, just like SEMI S2.

Safety Standards

- **CE marking**

For machinery and other equipment distributed in the EU (European Union), it is mandatory to display the CE mark. To display the CE mark, a product must declare itself to be in compliance with EU Directives. The main EU Directives relating to the products in this catalog are the Machinery Directive, EMC Directive and Low Voltage Directive. Each directive requires product compliance with the corresponding EN Standard (European Standard).

- **UL standards**

Standards of a non-profit testing organization founded by the US National Fire Protection Association.
In the US, some states and municipalities require UL certification for the sale of electrical products.

- **CSA standards**

Safety standards by the Canadian Standard Association, a non-governmental Canadian standardization organization.
Electrical products distributed in Canada must be CSA certified.

- **NRTL (National Recognized Test Laboratories)**

Testing organizations capable of certification (of UL or CSA standards etc.) which have been recognized according to Occupational Safety and Health Law set forth by OSHA (the US Occupational Safety and Health Administration). At present, 18 organizations have been recognized as NRTLs. UL and CSA are examples of certified organizations.

HRG
HRGC
HRZ
HRW
HEC
HEB
HED
Technical Data
Related Products

Temperature Control Equipment Related Products

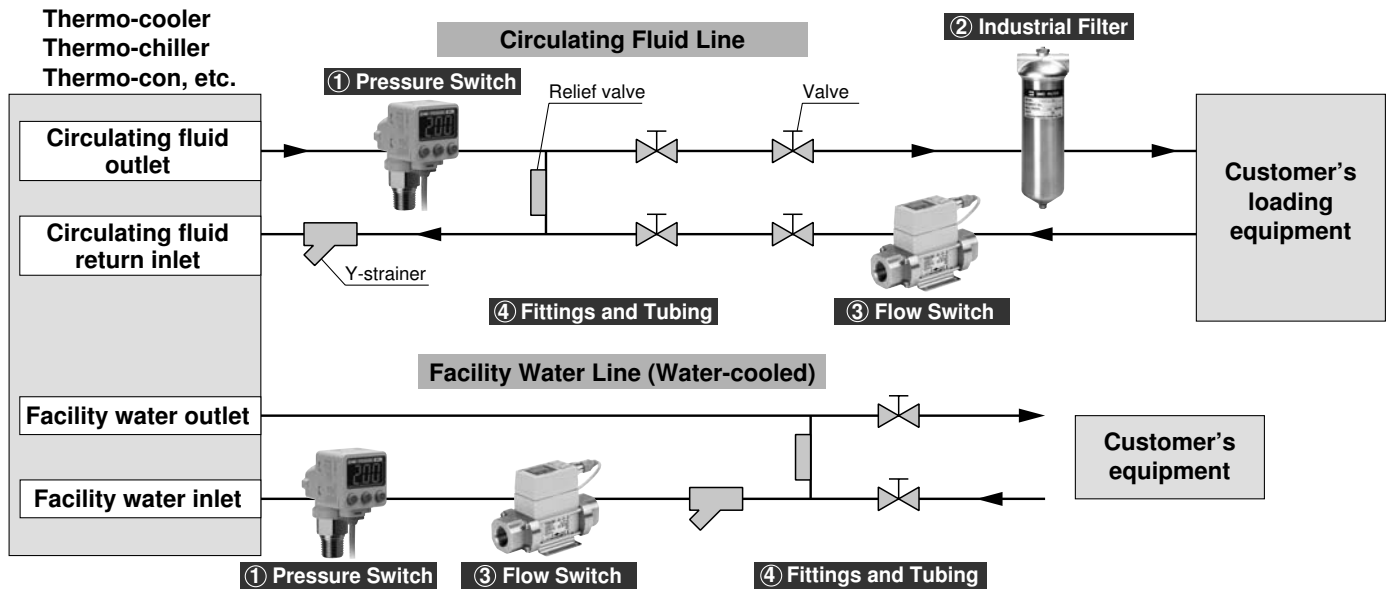

Refer to Best Pneumatics No. 6 for details.

① Pressure Switch: Monitors pressure of the circulating fluid and facility water.

2-Color Display High-Precision Digital Pressure Switch *ISE80*



Series	Type	Rated pressure range
ISE80	Positive pressure	-0.100 to 1.000 MPa
Features	<ul style="list-style-type: none"> • Suitable for a wide variety of fluids with stainless diaphragm • IP65 • RoHS compliant • Low leakage. VCR®, Swagelok® compatible fittings can be selected. • With one-touch fitting (Straight, Elbow) • Back piping, Underside piping 	

Pressure Sensor for General Fluids *PSE56*□

Separate type sensor



Series	Type	Rated pressure range
PSE564	Positive pressure	0 to 500 kPa
PSE560	Positive pressure	0 to 1 MPa
Features	<ul style="list-style-type: none"> • Wetted parts: Stainless steel 316L • IP65 • Suitable for a wide variety of fluids • Analog output (voltage/current) • Low leakage. VCR®, Swagelok® compatible fittings can be selected. 	

Multi-Channel Digital Pressure Sensor Controller *PSE200*

Separate type monitor



Series	Features
PSE200	<ul style="list-style-type: none"> • Four sensors can be connected. • Applicable sensors: PSE53□, 54□, 56□ • Capable of controlling various different applications from one controller • 4 inputs, 5 outputs

2-Color Display Digital Pressure Sensor Controller *PSE300*

Separate type monitor



Series	Features
PSE300	<ul style="list-style-type: none"> • Applicable sensors: PSE53□, 54□, 550, 56□ • Compatible with voltage input and current input • Response time: 1 ms • Space-saving, capable of vertical and horizontal contact mounting • Panel mount, Bracket, DIN rail mount

Refer to Best Pneumatics No. 7 for details.

② Industrial Filter: Filters the circulating fluid and facility water.

Industrial Filter/Vessel Series *FGD*



Series	Port size	Max. operating pressure	Temperature (°C)
FGD	Rc 3/8, 1/2, 3/4	0.7, 1 MPa	Max. 80
Features	<ul style="list-style-type: none"> • Ideal for low-flow filtration (Max. 60 ℓ/min) • Possible to select the antistatic specification (FGDE, FGDF). 		

High-Precision Filter for Fluid *FGH*



Series	Port size	Max. operating pressure	Temperature (°C)
FGH	Rc 3/8 to 1	1 MPa	Max. 80
Features	<ul style="list-style-type: none"> • Filtration efficiency: Removing over 99% 		

Quick Change Filter *FQ1*



Series	Port size	Max. operating pressure	Temperature (°C)
FQ1	Rc 1/2, 3/4, 1	1 MPa	Max. 80
Features	<ul style="list-style-type: none"> • Ideal for low flow filtration (Max. 30 ℓ/min) • No tools required • Takes only 60 seconds for element replacement 		

Refer to Best Pneumatics No. 6 for details.

③ Flow Switch: Monitors the flow rate of the circulating fluid and facility water.

Digital Flow Switch for Water *PF2W*

Integrated type



Monitor

Sensor

Separate type

Series	Set flow rate range (ℓ/min)
PF2W	0.5 to 4
	2 to 16
	5 to 40
	10 to 100
Features	<ul style="list-style-type: none"> • Integrated type and Separate monitor type are available. • Switch output, Accumulated pulse output, Analog output • Capable of switching back and forth between cumulative and instantaneous flow • Capable of operating at temperatures as high as 90°C • IP65

Digital Flow Switch for Deionized Water and Chemicals *PF2D*

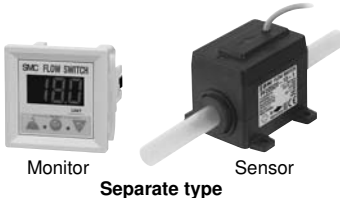

Monitor

Sensor

Separate type

Series	Set flow rate range (ℓ/min)
PF2D	0.4 to 4
	1.8 to 20
	4.0 to 40
Features	<ul style="list-style-type: none"> • Body sensor: New PFA, Tube: Super PFA • Low-particle generation, Excellent flow-through characteristics

4-Channel Flow Monitor *PF2□200*

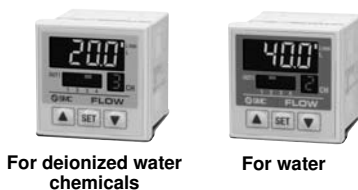

For deionized water chemicals

For water

Series	Applicable sensor	Set flow rate range (ℓ/min)
PF2W200/201	For water	PF2W5
		0.35 to 4.50
		1.7 to 17.0
		3.5 to 45.0
PF2D200/201	For deionized water/chemicals	PF2D5
		0.25 to 4.50
		1.3 to 21.0
		2.5 to 45.0
Features	<ul style="list-style-type: none"> • One controller can handle four units' worth of flow volume maintenance. • Four different flow ranges can be connected to one controller. 	

Related Products

Refer to Best Pneumatics No. 6 for details.

④ Fittings and Tubing

S Coupler

Series KK

- Fluid: **Air, Water**
- Applicable tubing O.D.: **ø3.2 to ø16**
- Applicable hose I.D./O.D.: **5/8 to 11/16**
- Port size: **M5 to 25A(3/4)**



S Coupler/Stainless Steel (Stainless Steel 304)

Series KKA

- Fluid: **Air, Water**
- Port size: **6A to 50A (1/8 to 11/2)**



Brass One-touch Fittings

Series KQB

- Fluid: **Air, Water**
- Applicable tubing O.D.: **ø4 to ø12**



Stainless Steel 316 One-touch Fittings

Series KQG

- Fluid: **Air, Water, Steam**
- Applicable tubing O.D.: **ø4 to ø12**



Stainless Steel 316 Insert Fittings

Series KFG

- Fluid: **Air, Water, Steam**
- Applicable tubing O.D.: **ø4 to ø12**



Fluoropolymer Fittings

Series LQ

- Fluid: **Deionized water, Chemicals, etc.**
(Please contact SMC for details.)
- Applicable tubing O.D.: **ø3 to ø25**



Tubing

Series T□

Series	Material	Fluid	O.D.
T	Nylon	Air, Water	ø4 to ø16
TU	Polyurethane	Air, Water	ø4 to ø16
TH	FEP (Fluoropolymer)	Air, Water, Inert gas	ø4 to ø12
TD	Modified PTFE (Soft fluoropolymer)	Air, Water, Inert gas	ø4 to ø12
TL	Super PFA	Deionized water, Chemicals, etc. ^{Note)}	ø4 to ø19

Length: Rolls up to 500 m in length are available, but please contact SMC for details because the maximum roll length varies depending on the tubing material and outer diameter. (Available with made-to-order specifications)

Note) Please contact SMC for details.



Temperature Control Equipment Warranty

1. Conditions of warranty

When a nonconformance should take place to our temperature control equipment, we will repair the unit without charge in accordance with our current terms and conditions.

This free repair covers the replacement of all nonconforming parts, their adjustment and checks. Please note that the disassembled parts will be the property of SMC.

2. Period of warranty

The warranty period of the product is 1 year in service or 1.5 years after the product is delivered.

3. Items out of warranty

The following cases are not subject to warranty.

1. Nonconformance caused by implementing no check-up (daily check-up, regular check-up) specified by SMC.
2. Nonconformance caused by the usage other than stipulated in the operating manual or outside the specification designated by SMC.
3. Nonconformance caused by remodeling which is not permitted by SMC.
4. Nonconformance caused by the usage other than the specified circulating fluid or facility water.
5. Nonconformance caused by elapsing. (painted surface, plated surface discolored naturally)
6. Sensuous phenomenon which is not affected functionally (sound, noise, vibration, etc.)
7. Nonconformance caused by natural disasters such as earthquake, typhoon, water disaster, accidents, or fire hazard.
8. Nonconformance caused by the installation environment stipulated in the operating manual.
9. Nonconformance caused by no observation to the following 5, "Items to be observed by customer."

4. Exemption from liability

1. Cost for daily check-up, regular check-up.
2. Cost for repair by a third party other than the designated distributors or agents.
3. Cost for moving this unit and installation or dislocation.
4. Cost for replacement or replenishment of the component parts or liquid other than specified.
5. Cost for inconvenience or loss caused by not being able to use the unit. (Telephone charge, warranty for job suspension, commercial loss, etc.)
6. Cost or compensation, etc. stipulated other than the above 1. "Conditions of warranty."

5. Items to be observed by customer

In order to use this product safely, the correct usage and check-up by customer are necessary.

Please be sure to observe the following things. Please note that we may decline the repair request upon warranty in case that the following things are not observed.

- 1) Use the unit in accordance to the proper handling as mentioned in the operating manual.
- 2) Conduct inspection and maintenance (daily check-up, regular check-up) as mentioned in the operating manual.
- 3) Record the inspection and maintenance results as mentioned in the operating manual.

6. How to ask a repair upon warranty

When a warranty repair is requested, please contact the nearest sales distributor.

With this, we will repair the unit upon warranty.

We promise a repair for free on the basis of the above mentioned periods or terms. Therefore, nonconformance occurred after the warranty period will be charged in principle.





Safety Instructions

These safety instructions are intended to prevent hazardous situations and/or equipment damage. These instructions indicate the level of potential hazard with the labels of “**Caution**,” “**Warning**” or “**Danger**.” They are all important notes for safety and must be followed in addition to International Standards (ISO/IEC), Japan Industrial Standards (JIS)*1) and other safety regulations*2).

- * 1) ISO 4414: Pneumatic fluid power – General rules relating to systems.
- ISO 4413: Hydraulic fluid power – General rules relating to systems.
- IEC 60204-1: Safety of machinery – Electrical equipment of machines. (Part 1: General requirements)
- ISO 10218-1992: Manipulating industrial robots -Safety.
- JIS B 8370: General rules for pneumatic equipment.
- JIS B 8361: General rules for hydraulic equipment.
- JIS B 9960-1: Safety of machinery – Electrical equipment of machines. (Part 1: General requirements)
- JIS B 8433-1993: Manipulating industrial robots - Safety.
- etc.
- * 2) Labor Safety and Sanitation Law, etc.

 **Caution:** Operator error could result in injury or equipment damage.

 **Warning:** Operator error could result in serious injury or loss of life.

 **Danger :** In extreme conditions, there is a possibility of serious injury or loss of life.

Warning

1. The compatibility of the product is the responsibility of the person who designs the equipment or decides its specifications.

Since the product specified here is used under various operating conditions, its compatibility with specific equipment must be decided by the person who designs the equipment or decides its specifications based on necessary analysis and test results. The expected performance and safety assurance of the equipment will be the responsibility of the person who has determined its compatibility with the product. This person should also continuously review all specifications of the product referring to its latest catalog information, with a view to giving due consideration to any possibility of equipment failure when configuring the equipment.

2. Only personnel with appropriate training should operate machinery and equipment.

The product specified here may become unsafe if handled incorrectly. The assembly, operation and maintenance of machines or equipment including our products must be performed by an operator who is appropriately trained and experienced.

3. Do not service or attempt to remove product and machinery/equipment until safety is confirmed.

1. The inspection and maintenance of machinery/equipment should only be performed after measures to prevent falling or runaway of the driven objects have been confirmed.
2. When the product is to be removed, confirm that the safety measures as mentioned above are implemented and the power from any appropriate source is cut, and read and understand the specific product precautions of all relevant products carefully.
3. Before machinery/equipment is restarted, take measures to prevent unexpected operation and malfunction.

4. Contact SMC beforehand and take special consideration of safety measures if the product is to be used in any of the following conditions.

1. Conditions and environments outside of the given specifications, or use outdoors or in a place exposed to direct sunlight.
2. Installation on equipment in conjunction with atomic energy, railways, air navigation, space, shipping, vehicles, military, medical treatment, combustion and recreation, or equipment in contact with food and beverages, emergency stop circuits, clutch and brake circuits in press applications, safety equipment or other applications unsuitable for the standard specifications described in the product catalog.
3. An application which could have negative effects on people, property, or animals requiring special safety analysis.
4. Use in an interlock circuit, which requires the provision of double interlock for possible failure by using a mechanical protective function, and periodical checks to confirm proper operation.



Safety Instructions

Caution

The product is provided for use in manufacturing industries.

The product herein described is basically provided for peaceful use in manufacturing industries.

If considering using the product in other industries, consult SMC beforehand and exchange specifications or a contract if necessary. If anything is unclear, contact your nearest sales branch.

Limited Warranty and Disclaimer/Compliance Requirements

The product used is subject to the following “Limited Warranty and Disclaimer” and “Compliance Requirements”. Read and accept them before using the product.

Limited Warranty and Disclaimer

1. The warranty period of the product is 1 year in service or 1.5 years after the product is delivered.*3)

Also, the product may have specified durability, running distance or replacement parts. Please consult your nearest sales branch.

2. For any failure or damage reported within the warranty period which is clearly our responsibility, a replacement product or necessary parts will be provided.

This limited warranty applies only to our product independently, and not to any other damage incurred due to the failure of the product.

3. Prior to using SMC products, please read and understand the warranty terms and disclaimers noted in the specified catalog for the particular products.

* 3) Vacuum pads are excluded from this 1 year warranty.

A vacuum pad is a consumable part, so it is warranted for a year after it is delivered.

Also, even within the warranty period, the wear of a product due to the use of the vacuum pad or failure due to the deterioration of rubber material are not covered by the limited warranty.

Compliance Requirements

When the product is exported, strictly follow the laws required by the Ministry of Economy, Trade and Industry (Foreign Exchange and Foreign Trade Control Law).



Temperature Control Equipment Precautions 1

Be sure to read this before handling. Refer to back pages 1 and 2 for Safety Instructions and the main text for Specific Product Precautions on every series.

Selection

Warning

1. Confirm the specifications.

Fully understand the applications, environment, fluids and other operating conditions. Use this product within the specified range shown in this catalog. Using outside the specified range can cause injury, damage, or malfunction. When in doubt, please contact SMC beforehand.

2. Secure the performance margin.

When you consider the product's cooling/heating performance or flow characteristics, allowance must be made because there are heat loss from the piping, etc. or pressure drop.

Operating Environment / Storage Environment

Warning

1. Observe the ambient temperature range.

The operating ambient temperature range must be within the specification range shown in this catalog.
Use caution because using beyond the range will lead to damage, breakage or malfunction.

2. Avoid using and storing in the following environment because it will lead to malfunction.

1. In locations where water, water steam, salt water, and oil may splash on the product.
2. In locations where a large amount of particles are airborne.
3. In locations with an atmosphere of corrosive or explosive gases, solvents, or chemicals.
(This product is not explosion proof.)
4. In locations which receive direct sunlight or radiated heat.
(Protect from direct sunshine to avoid the resin from deteriorating by ultraviolet rays or increasing the temperature.)
5. In locations where temperature substantially changes.
6. In locations where there is a heat source nearby and the ventilation is poor.
(Insulate the heat source or ventilate well to avoid damages caused by the heat or temperature increase, such as softening.)
7. In locations where condensation occurs.
8. In locations where strong magnetic noise occurs.
(In locations where strong electric fields, strong magnetic fields and surge voltage occur.)
9. In locations where static electricity occurs, or conditions which make the product discharge static electricity.
10. In locations where high frequency occurs.
11. In locations where damage is likely to occur due to lightning.
12. In locations where impacts or vibrations occur.
13. In conditions where a massive force strong enough to deform the product is applied or a weight from a heavy object is applied.
14. In locations more than 1000 m in altitude (except storage, transportation).

Fluid

Warning

1. Type of fluids

1. The operating fluids must be used within the specified range shown in this catalog.
Please consult with SMC when using the product with other fluids.
2. Depending on the combination, foreign matter, chemical leakage and catalysts may change the piping material and operating fluid qualities.
3. When solid foreign objects may be mixed with a fluid, install a filter to remove them.

Transportation / Transfer / Movement

Warning

1. Product transfer should be performed by a knowledgeable and experienced person.

Especially, transferring a heavy object is dangerous.
Use adequate caution to prevent falling down or dropping accidents from occurring.

2. Avoid transportation in the following environment because it will lead to breakage.

1. In conditions where strong shock and vibrations occur.
2. In operating and storage environments other than those specified.

3. Caution when transferring a heavy object

This product is heavy. Use adequate caution to avoid injury when picking up and setting down the product, and falling and dropping accidents should be avoided.

4. Before moving this product, remove operating fluid, facility water from the inside of this product.

Mounting / Installation

Warning

1. Installation should be performed by a knowledgeable and experienced person.

Especially, installation of a heavy object is dangerous.
Use adequate caution to avoid falling and dropping accidents from occurring.

Caution

1. Provide space for ventilation and maintenance.

Provide enough space for the ventilation requirement of each equipment. Otherwise, a cooling malfunction or operation stoppage may occur. Also, provide space required for maintenance.

2. Verify the mounting orientation.

Mount and install horizontally.



Temperature Control Equipment Precautions 2

Be sure to read this before handling. Refer to back pages 1 and 2 for Safety Instructions and the main text for Specific Product Precautions on every series.

Piping

Warning

- 1. For this product and future equipment, design of the piping system should be performed by a knowledgeable and experienced person.**
- 2. Work performed on the piping should be done by a knowledgeable and experienced person.**
If work performed on the piping is done by a less knowledgeable and inexperienced person, it will likely lead to operating fluid leakage, etc.
- 3. Thoroughly read the operating manual.**
Read the operating manual completely before piping. Also, keep the manual where it can be referred to as necessary.
- 4. Tighten threads with the proper tightening torque.**

When installing piping, etc., follow the given torque levels below.

Piping Tightening Torque

Connection thread	Proper tightening torque (N·m)
M5	1.5 to 2
Rc 1/8	7 to 9
Rc 1/4	12 to 14
Rc 3/8	22 to 24
Rc 1/2	28 to 30
Rc 3/4	28 to 30
Rc 1	36 to 38
Rc 1 1/4	40 to 42
Rc 1 1/2	48 to 50
Rc 2	48 to 50

- 5. Confirm the leakage of fluid.**

Confirm that the hose or tubing is not pulled out and that there is no leakage in the fitted parts.

Caution

- 1. Refer to the Fittings and Tubing Precautions (Best Pneumatics No. 6) for handling one-touch fittings.**
- 2. Preparation before piping**
Before piping is connected, it should be thoroughly blown out with air (flushing) or washed to remove chips, cutting oil and other debris from inside the pipe.
- 3. Use caution regarding the flowing direction of the fluid.**
When installing piping to a product, do not mistake the flow direction of supply port, etc. Check "IN" and "OUT" or labels and the operating manual before connection.
- 4. Sealant tape**
When installing piping or fitting into a port, ensure that sealant material does not enter the port internally. When using sealant tape, leave 1.5 to 2 threads exposed on the end of pipe/fitting.
- 5. Take countermeasures against condensation.**
Depending on the operating condition, condensation may occur in the piping. In such a case, take countermeasures such as installing insulation material, etc.



Temperature Control Equipment Precautions 3

Be sure to read this before handling. Refer to back pages 1 and 2 for Safety Instructions and the main text for Specific Product Precautions on every series.

Electrical Wiring

Warning

1. Electrical wiring job should be performed by a knowledgeable and experienced person.

Power supply facilities and wiring works should be implemented in accordance with the electric facilities technical standards and provisions and conducted correctly.

2. Mounting a dedicated ground fault circuit interrupter

As a countermeasure against current leakage, install a ground fault circuit interrupter (GFCI) in the main power supply.

3. Check the power supply.

If this product is used with voltages other than specified, it will likely lead to a fire or an electrical shock. Before wiring, confirm the voltage, volume, and frequency.

Confirm that the voltage fluctuation is within $\pm 10\%$ of the specified value.

4. Grounding

Be certain to ground (frame ground) with class D grounding (grounding resistance of 100 Ω or less).

Can be grounded with the PE line of the power supply cable.

Also, do not use together with equipment that generates a strong electrical magnetic noise or high frequency noise.

5. Wiring cable should be handled with care.

Do not bend, twist or stretch the cord or cable.

6. Wire with an applicable size cable and terminal.

In the event of attaching a power supply cable, use a cable and terminal size which is suitable for the electrical current of each product.

Forcibly mounting with an unsuitable size cable will likely result in a fire.

7. Avoid wiring the signal line and power line in parallel.

Since there may be a possibility of malfunction from noise, avoid parallel wiring between the temperature sensor line, communication line, signal line of alarm line, etc. and the power line and high voltage line. Also, do not place them in the same wiring tube.

Facility Water Supply

(Water-cooled refrigeration)

Warning

1. Be certain to supply the facility water.

1. Prohibition of water-cut operation, very little flow rate of water operation.

Do not operate under the condition that there is no facility water or where there is very little flow rate of water is flowing. In this kind of operation, facility water temperature may become extremely higher. It is dangerous enough the material of hose may soften and burst when the piping supplying the facility water is connected with hose.

2. Actions to be taken when an emergency stop occurs due to high temperature.

In case a stop occurs due to extremely high temperature resulting from a decrease in the facility water flow rate, do not immediately flow facility water. It is dangerous enough the material of hose may soften and burst when the piping supplying the facility water is connected with hose.

First, naturally let it cool down by removing the cause of the flow rate reduction. Secondly, confirm that there is no leakage again.

Caution

1. Facility water quality

1. Use the facility water within the specified range as shown below.

When using with other fluid than facility water, please consult with SMC.

2. When it is likely that foreign objects may enter the fluid, install a filter (20 mesh or equivalent).

Facility Water Quality Standard

The Japan Refrigeration and Air Conditioning Industry Association



JRA GL-02-1994 "Cooling water system – Circulation type – Circulating water"

	Item	Unit	Standard value
Standard item	pH (at 25°C)	—	6.5 to 8.2
	Electrical conductivity (25°C)	[μ S/cm]	100* to 800*
	Chloride ion (Cl ⁻)	[mg/L]	200 or less
	Sulfuric acid ion (SO ₄ ²⁻)	[mg/L]	200 or less
	Acid consumption amount (at pH4.8)	[mg/L]	100 or less
	Total hardness	[mg/L]	200 or less
	Calcium hardness (CaCO ₃)	[mg/L]	150 or less
Reference item	Ionic state silica (SiO ₂)	[mg/L]	50 or less
	Iron (Fe)	[mg/L]	1.0 or less
	Copper (Cu)	[mg/L]	0.3 or less
	Sulfide ion (S ₂ ⁻)	[mg/L]	Should not be detected.
	Ammonium ion (NH ₄ ⁺)	[mg/L]	1.0 or less
	Residual chlorine (Cl)	[mg/L]	0.3 or less
	Free carbon (CO ₂)	[mg/L]	4.0 or less

* In the case of [M Ω ·cm], it will be 0.00125 to 0.01.

Circulating Fluid Temperature Controller Refrigerated Thermo-cooler

Makes cooling water easily available, anytime, anywhere.

- Worldwide in voltage: Single phase 200 to 230 VAC, 50/60 Hz
- Compliant with overseas standards: , 
- Energy saving: Stop-idling function ($\pm 1^{\circ}\text{C}$ type)
Automatic facility-water-saving function (water-cooled)
- Environmentally friendly: RoHS compliant, Refrigerant R407C
- Selectable performance: Temperature stability $\pm 1^{\circ}\text{C}$ (Refrigerator ON/OFF control), $\pm 0.5^{\circ}\text{C}$ (Proportional valve PID control)
- Easy installation: No need for facility water (air-cooled), Caster, by-pass valve and strainer (water-cooled), Stainless steel drain pan available as standard equipment, No need for power supply for remote operation
- Easy maintenance: "Alarm code" display, Accessible from the front electric control panel

A variety of "Options" and "Optional Accessories" (Pages 9 to 14)

NEW

 Newly added function

Options

- With ground fault circuit interrupter
- With communications function (RS-485)
- With communications function (RS-232C)
- With water leakage sensor
- With heater
- With automatic water supply function
- With external switch inlet
- Stainless steel wetted part for circulating fluid
- High-lift pump
- With DI control kit

Optional accessories

- Dustproof filter set
- By-pass piping set
- DI (Deionized water) filter
- Insulating material for DI (Deionized water) filter



- Cooling capacity (60 Hz):
1.1 kW/2.3 kW/4.8 kW (Air-cooled refrigeration/Water-cooled refrigeration)
- Temperature stability: $\pm 1^{\circ}\text{C}$ (Refrigerator ON/OFF control) /
 $\pm 0.5^{\circ}\text{C}$ (Proportional valve PID control)
- Temperature range setting: **5 to 35 $^{\circ}\text{C}$**

Series **HRGC**



CAT.ES40-51B

Energy Saving and Environmentally Friendly

Power consumption: Max. 74% reduction

When the circulating fluid reaches a certain preset temperature, the refrigerator stops temporarily (idling stop) and the temperature is adjusted even in processes where there is heat loading, performance is at least as good as that of inverter control.

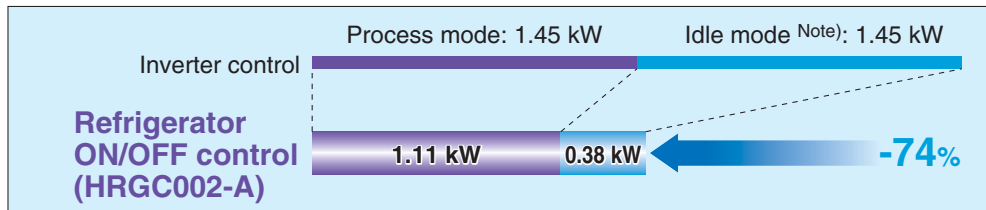

Note) Operating conditions: Process mode: Circulating fluid temperature 20°C, Heat load 2 kW
Idle mode: Circulating fluid temperature 20°C, Heat load 0 kW

- Reduced running cost
- Contribution to the environmental preservation

Refrigerant: Max. 35% reduction (SMC comparison)

Conventionally, reducing the amount of refrigerant gas has meant a reduction in cooling performance. Now, however, the use of an improved high-performance **heat exchanger** (Note) makes it possible to reduce the volume of refrigerant used (refrigerant charge volume) without sacrificing cooling performance.

- More environmentally friendly

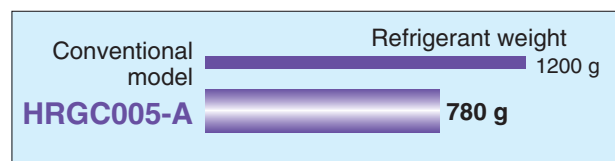

Note) HRGC005-A only

Selectable Performance

Temperature stability: $\pm 0.5^{\circ}\text{C}$ (Note 1) 3) $\pm 1.0^{\circ}\text{C}$ (Note 2) 3) (when a load is stable)

Two types of temperature control are provided: to $\pm 0.5^{\circ}\text{C}$ specifications using split flow from a three-way proportional valve, and simple temperature control to $\pm 1.0^{\circ}\text{C}$ specifications using the refrigerator ON/OFF mechanism. Choose the temperature stability that is right for your manufacturing process and method.

■ $\pm 0.5^{\circ}\text{C}$ type (HRGC002-A5)

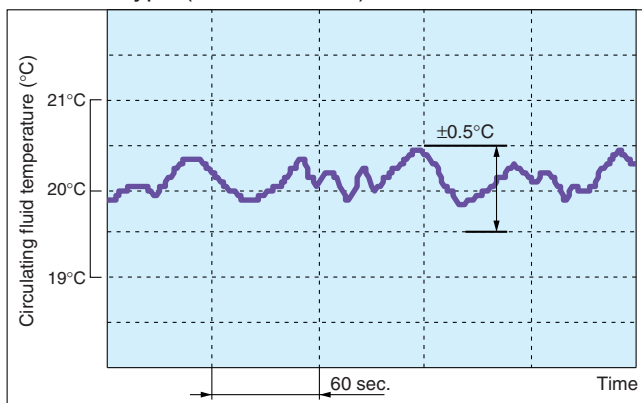

Note 1) HRGC001-□5 to HRGC005-□5 only

Note 2) HRGC001-□ to HRGC005-□

■ $\pm 1.0^{\circ}\text{C}$ type (HRGC002-A)

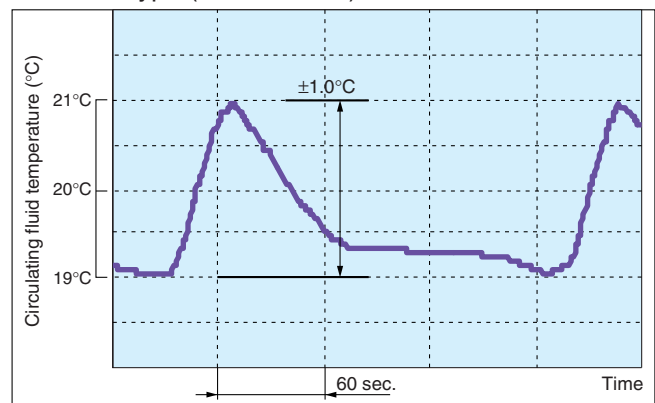

Note 3) The value shown applies to a stable load state with no outside interference.

Actual values may vary depending on the operating conditions.

Material compatible with a wide variety of circulating fluids is used for wetted parts.

- Aqueous solution of 15% ethylene glycol
- Clear water, Deionized water (Note)

Note) Supply water with electrical conductivity of $1 \mu\text{S/cm}$ or more.

However, the same level of electrical conductivity cannot be maintained.

Optional DI control kit (symbol Y) is available to keep electrical resistance. Refer to page 12 for details.

Easy Installation and Maintenance

Simple operation

Operation 1
Press the **START** button.

Operation 2
Adjust the temperature setting with the **UP/DOWN** keys.

Operation 3
Press the **STOP** button to shut down.
What could be easier?!

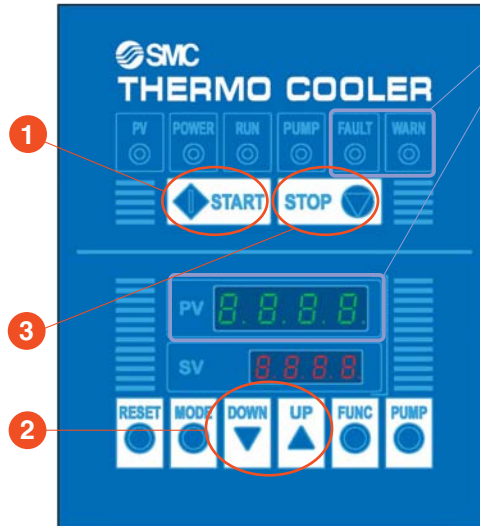

With alarm code indicators

Fault, Warn and alarm code indicators for easy failure diagnosis

- Fault (FAULT) indicator (red LED)
- Warning (WARN) indicator (yellow LED)

Note) Refer to page 7 for operation display panel and alarms.

Contact input/output signal

Remote operation signal input

No need for power supply. Startup and shut-down can be remotely controlled.

Operation, shutdown, alarm signal output

Operation, shutdown, alarm signal can be output via the relay contact.

Easy maintenance

Components can be accessed from the front. The pump, refrigerator thermal relay and reset switch are located inside the electrical component enclosure.

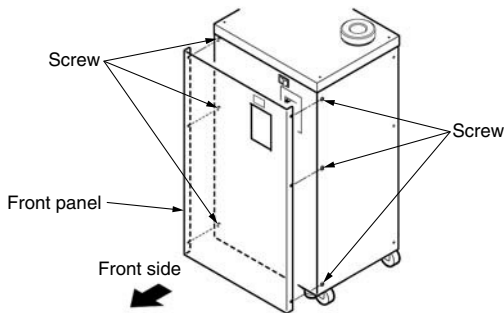

Options

- With ground fault circuit interrupter
 - With communications function (RS-485)
 - With communications function (RS-232C)
 - With water leakage sensor
 - With heater
 - With automatic water supply function
 - With external switch inlet
 - Stainless steel wetted part for circulating fluid
 - High-lift pump
 - With DI control kit
- (Refer to pages 9 to 12 for options.)

Optional accessories

Dustproof filters for the air-cooled refrigeration and by-pass piping set for preventing pressure increase are available. These improve durability and ease of use.
(Refer to pages 13 and 14 for optional accessories.)

Caster available as standard equipment

Can be used when the Thermo-cooler is carried onto the floor or moved to change the layout. Also, there is an adjuster which can be used as a stopper.

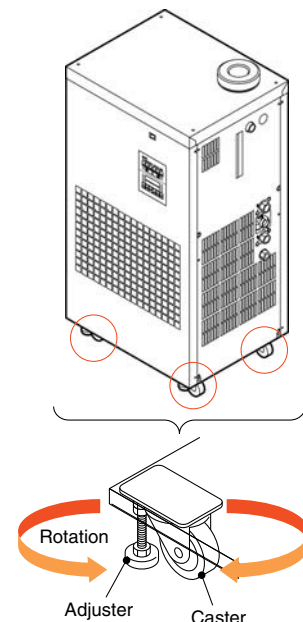

Air-Cooled Refrigeration

Air-cooled refrigeration

Unlike the water-cooled refrigeration, the air-cooled refrigeration does not require a facility water, and is easy to install alongside your equipment.

Communications

- **Communications function (RS-485, RS-232C)**
(Refer to pages 9 to 12 options.)
- **Contact input/output function**
(Refer to page 8.)

Application Examples

Semiconductor

Example: Temperature control of a chamber electrode

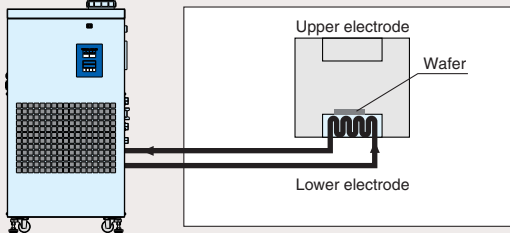

- Etching equipment
- Spatter equipment
- Cleaning equipment
- Coating equipment
- Dicing equipment
- Tester, etc.

Medical

Example: Blood preservation

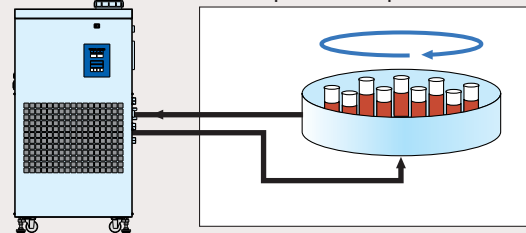

- X-ray instrument
- MRI
- Blood preservation equipment

Food

Example: Tofu (Bean curd) production

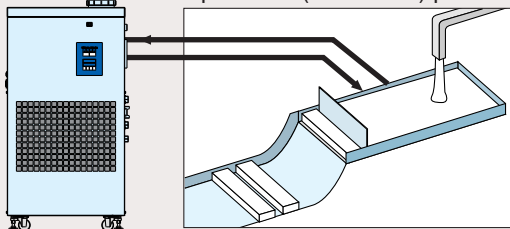

- Bottle-cleaning machine
 - Tofu (Bean curd) production equipment
 - Noodle-making machine, etc.
- Water temperature control for forming tofu by mixing the boiled soy-bean milk and bitter

Analysis

Example: Electronic microscope

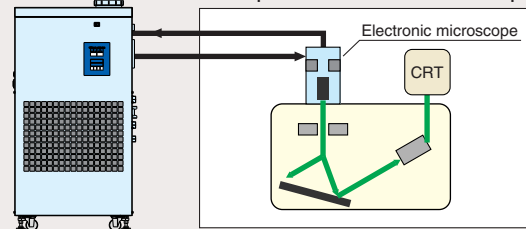

- Electron microscope
 - X-ray analytical instrument
 - Gas chromatography
 - Sugar level analytical instrument, etc.
- Prevents the distortion caused by the heat generated by the electronic gun in an electronic microscope.

Machine tool

Example: Laser machining

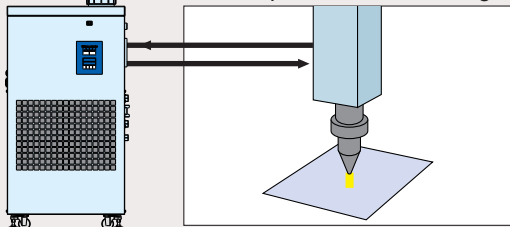

- Wire cutting
 - Grinder
 - Spot welding
 - Plasma welding
 - Laser machining, etc.
- Temperature-controlling the laser generating tube enables the laser wavelength to be optimised, improving the accuracy of the machined cross sectional area.

Printing

Example: Printing temperature control

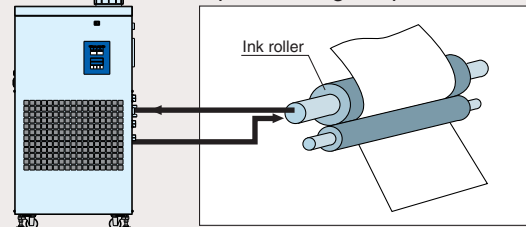

- Offset printing machine
 - Automatic developing machine
 - UV equipment, etc.
- Temperature-controlling the ink roller enables to control the evaporation amount and viscosity of an ink and optimise the tint of colors.

Molding

Example: Injection molding

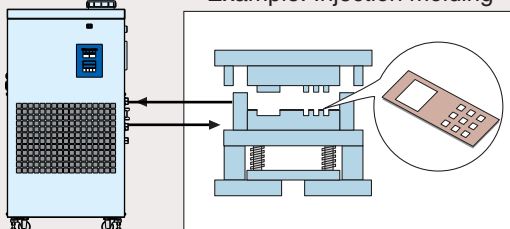

- Plastic molding
 - Rubber molding
 - Wire cable coating machine
 - Injection molding, etc.
- Temperature-controlling the mold results in improved product quality.

Construction and Principles

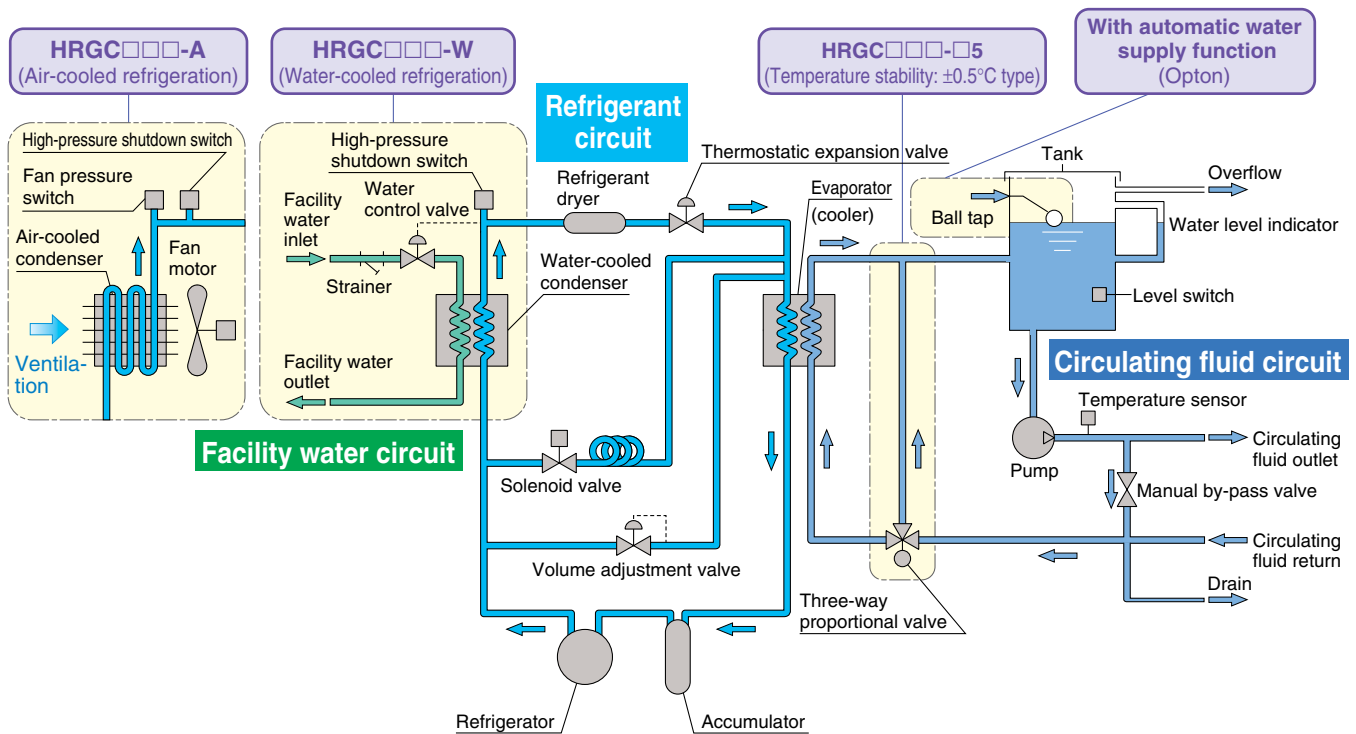

Circulating fluid circuit

With the circulating pump, circulating fluid will be discharged to the customer's equipment side. After the circulating fluid will cool the customer's equipment side, it will heat up and return to the Thermo-cooler.

Temperature stability: $\pm 0.5^{\circ}\text{C}$ type (HRGC□□□-□5)

If the temperature of the circulating fluid is higher than the preset temperature, the three-way proportional valve will return the circulating fluid to the cooler. If the temperature of the circulating fluid is lower than the preset temperature, the fluid will be returned directly to the tank.

When the temperature of the circulating fluid is nearly the same as the preset temperature, the temperature will be stabilized by split flow between the cooler and the tank.

Refrigerant circuit

High-temperature, high-pressure freon gas compressed by the refrigerator is made to release heat by the condenser, and turns to liquid. As the liquefied high-pressure freon passes through the thermostatic expansion valve, it expands and cools down; as it passes through the evaporator, heat is extracted from the circulating fluid and it evaporates.

The evaporated freon is once again sucked in and compressed by the refrigerator, and the above cycle is repeated.

When the circulating fluid is cooled sufficiently, the solenoid valve and volume adjustment valve open. These valves balance the refrigerant pressure and prevent freezing of the circulating fluid in excessively cold conditions.

Temperature stability: $\pm 1.0^{\circ}\text{C}$ type (HRGC□□□-□)

If the temperature of the circulating fluid is higher than the preset temperature, the refrigerator starts up, and freon gas flows to the evaporator (cooler). This cools the circulating fluid. If the temperature of the circulating fluid is lower than the preset temperature, the refrigerator shuts down, and the flow of freon gas stops. At such times, the circulating fluid is not cooled, and the temperature rises.

Temperature stability is achieved by the refrigerator starting up and shutting down.

Facility water circuit

Cooling method: Water-cooled refrigeration (HRGC□□□-W)

When the freon gas is adequately liquefied and the circulating fluid is adequately cooled, the water control valve automatically closes the facility water circuit and adjusts the flow of facility water.

This method assures normal pressure in the refrigerator and reduces energy use by your facility water equipment.

CONTENTS

Series *HRGC*

Model Selection

- Guide to Model Selection Front matter 2
- Calculation of Required Cooling Capacity ... Front matter 3 to 4
- Precautions on Model Selection Front matter 4
- Circulating Fluid Typical Physical Property Values Front matter 4

● **Basic Model**

- How to Order/Specifications P.1 to 2
- Cooling Capacity/Pump Capacity/
Facility Water Flow Rate P.3
- Dimensions: Air-Cooled Refrigeration P.4
- Dimensions: Water-Cooled Refrigeration P.5
- Piping Connection and Installation Dimensions ... P.6
- Operation Panel Display P.7
- Alarm P.7
- Contact Input/Output Function P.8
- Other Features P.8

● **Options**

- With Ground Fault Circuit Interrupter P.9
- With Communications Function (RS-485) P.9
- With Water Leakage Sensor P.9
- With Heater P.9
- With Automatic Water Supply Function P.10
- With External Switch Inlet P.10
- Stainless Steel Wetted Part for Circulating Fluid ... P.11
- With Communications Function (RS-232C) P.11
- High-lift Pump P.12
- With DI Control Kit P.12

● **Optional Accessories**

- Dustproof Filter Set P.13
- By-pass Piping Set P.13
- DI (Deionized Water) Filter P.14
- Insulating Material for DI (Deionized Water) Filter ... P.14

Specific Product Precautions P.15 to 17

Safety Instructions Back cover

Series HRGC Model Selection

Guide to Model Selection

1. Which is best for you: a water-cooled refrigeration or an air-cooled refrigeration?

You should base your choice on the configuration of your equipment.

Thermo-cooler series refrigeration methods

Water-cooled refrigeration

Requires facility water equipment (cooling tower etc.) as well as electrical power supply. This type provides stable cooling performance year round, regardless of ambient temperature changes.

Air-cooled refrigeration

Only electrical power supply is needed.

Facility water equipment is not necessary, so the system is easy to install wherever you need it, when you need it.

(Note that ventilation or air conditioning is required to dissipate heat: for details, refer to page 15. Operating Environment / Storage Environment 3 on Specific Product Precautions 1.)

Example) Customer requirement: Air-cooled refrigeration

2. How much is the temperature in degrees centigrade for the circulating fluid?

Temperature range which can be set with the Thermo-cooler

5°C to 35°C

Example) Customer requirement: 20°C

3. What power supply frequency?

Thermo-cooler power supply frequency specifications

50 Hz, 60 Hz (common use)

Example) Customer requirement: 60 Hz

4. What is the kW for the required cooling capacity?

* To calculate the cooling capacity, refer to example 1 to 3.

Example) Customer requirement: 4.2 kW (Refer to example 1 (1).)

Selection

Example: Customer requirements 1 to 4

Cooling method : Air-cooled refrigeration
 Circulating fluid temperature: 20°C
 Power supply frequency : 60 Hz
 Required cooling capacity : 4.2 kW

Based on the results of 1 to 4, refer to the graph of cooling capacity of an air-cooled refrigeration Thermo-cooler at 60 Hz (page 3). On the same graph, plot the intersections between the customer's required temperature (20°C) and cooling capacity (4.2 kW).

[Cooling Capacity Graph] Cooling Method: Air-cooled Refrigeration, Power Supply Frequency: 60 Hz

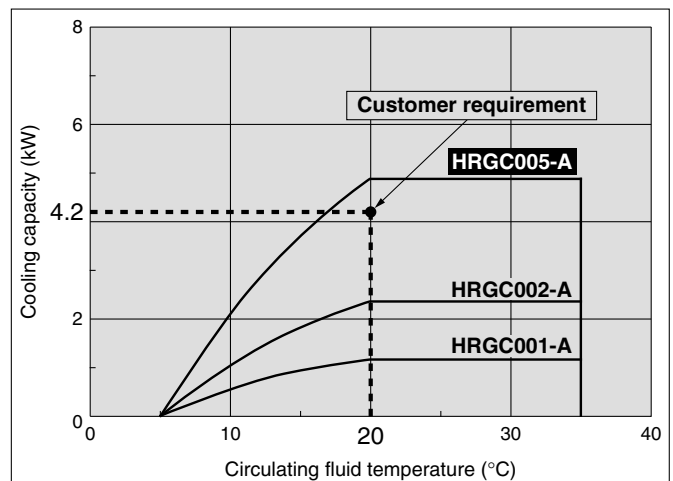

The point plotted in the graph is the requirement from your customer. Select the Thermo-cooler models exceeding this point. In this case, select the **HRGC005-A**.

Calculation of Required Cooling Capacity

Example 1: When the heat generation amount in the customer's equipment is known.

The heat generation amount can be determined based on the power consumption or output of the heat generating area — i.e. the area requiring cooling — within your facility.

(1) Derive the amount of heat generated from the power consumption.

Power consumption **P**: 3.5 [kW]

$$Q = P = 3.5 \text{ [kW]}$$

Cooling capacity = Considering a safety factor of 20%,
 $3.5 \text{ [kW]} \times 1.2 = 4.2 \text{ [kW]}$

(2) Derive the amount of heat generated from the power supply output.

Power supply output **VI**: 4.1 [kVA]

$$Q = P = V \times I \times \text{Power factor}$$

In this example, using a power factor of 0.85:

$$= 4.1 \text{ [kVA]} \times 0.85 = 3.5 \text{ [kW]}$$

Cooling capacity = Considering a safety factor of 20%,
 $3.5 \text{ [kW]} \times 1.2 = 4.2 \text{ [kW]}$

(3) Derive the amount of heat generated from the output.

Output (shaft power, etc.) **W**: 2.2 [kW]

$$Q = P = \frac{W}{\text{Efficiency}}$$

In this example, use an efficiency of 0.7:

$$= \frac{2.2}{0.7} = 3.14 \text{ [kW]}$$

Cooling capacity = Considering a safety factor of 20%,
 $3.14 \text{ [kW]} \times 1.2 \approx 3.8 \text{ [kW]}$

* The above examples calculate the heat generation amount based on the power consumption.

The actual heat generation amount may differ due to the structure of customer facilities.

Please be sure to check it carefully.

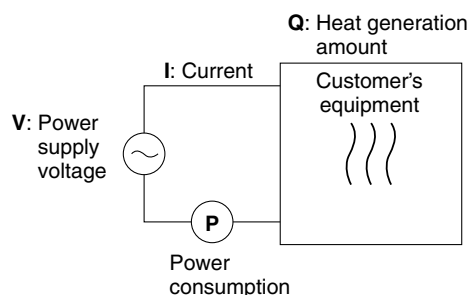

Example 2: When the heat generation amount in the customer's equipment is not known.

Obtaining the temperature difference between inlet and outlet by circulating the circulating fluid inside the customer's equipment.

Amount of heat generated by equipment **Q**: Unknown [kW] ([kJ/s])
 Circulating fluid : Clear water*
 Circulating fluid flow rate (weight) q_m : (= $\rho \times q_v \div 60$) [kg/s]
 Circulating fluid density ρ : 1 [kg/dm³]
 Circulating fluid flow rate (volume) q_v : 25 [dm³/min]
 Circulating fluid specific heat capacity **C** : 4.2 [kJ/(kg·K)]
 Circulating fluid outlet temperature **T₁** : 293 [K] (20 [°C])
 Circulating fluid return temperature **T₂** : 295 [K] (22 [°C])
 Circulating fluid temperature difference ΔT : 2.0 [K] (= $T_2 - T_1$)
 Conversion factor: minutes to seconds : 60 [s/min]
 (SI units)

* Refer to front matter 4 for the typical physical property values of clear water or other circulating fluids.

$$Q = q_m \times C \times (T_2 - T_1)$$

$$= \frac{\rho \times q_v \times C \times \Delta T}{60}$$

$$= \frac{1 \times 25 \times 4.2 \times 2.0}{60}$$

$$= 3.50 \text{ [kJ/s]} \approx 3.5 \text{ [kW]}$$

Cooling capacity = Considering a safety factor of 20%,
 $3.5 \text{ [kW]} \times 1.2 = 4.2 \text{ [kW]}$

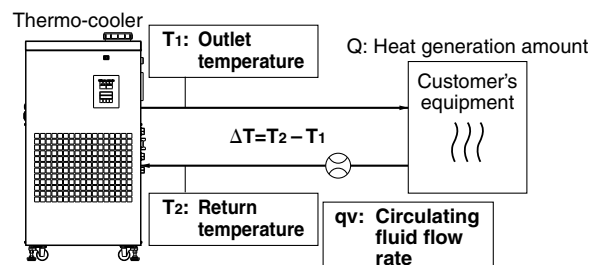

Example of the conventional measurement units (Reference)

Amount of heat generated by equipment **Q** : Unknown [kcal/h] → [kW]
 Circulating fluid : Clear water*
 Circulating fluid flow rate (weight) q_m : (= $\rho \times q_v \times 60$) [kgf/h]
 Circulating fluid weight: volume ratio γ : 1 [kgf/l]
 Circulating fluid flow rate (volume) q_v : 25 [d/min]
 Circulating fluid specific heat capacity **C** : 1.0 [kcal/(kgf·°C)]
 Circulating fluid outlet temperature **T₁** : 20 [°C]
 Circulating fluid return temperature **T₂** : 22 [°C]
 Circulating fluid temperature difference ΔT : 2.0 [°C] (= $T_2 - T_1$)
 Conversion factor: hours to minutes : 60 [min/h]
 Conversion factor: kcal/h to kW : 860 [(kcal/h)/kW]

$$Q = \frac{q_m \times C \times (T_2 - T_1)}{860}$$

$$= \frac{\gamma \times q_v \times 60 \times C \times \Delta T}{860}$$

$$= \frac{1 \times 25 \times 60 \times 1.0 \times 2.0}{860}$$

$$= \frac{3000 \text{ [kcal/h]}}{860}$$

$$\approx 3.5 \text{ [kW]}$$

Cooling capacity = Considering a safety factor of 20%,
 $3.5 \text{ [kW]} \times 1.2 = 4.2 \text{ [kW]}$

Model Selection

Calculation of Required Cooling Capacity

Example 3: When there is no heat generation, and when cooling the object below a certain temperature and period of time.

Heat dissipated by cooled substance (per unit time) Q : Unknown [kW] ([kJ/s])
 Cooled substance : Water
 Cooled substance weight m : (= ρ × V) [kg]
 Cooled substance density ρ : 1 [kg/dm³]
 Total volume of the object being cooled down V : 60 [dm³]
 Specific heat capacity of cooled substance C : 4.2 [kJ/(kg·K)]
 Temperature of cooled substance when cooling begins T₀ : 305 [K] (32 [°C])
 Cooled substance temperature after t hour T_t : 293 [K] (20 [°C])
 Cooling temperature difference ΔT : 12 [K] (=T₀ - T_t)
 Cooling time Δt : 900 [s] (= 15 [min])

* Refer to the lower right for the typical physical property value by circulating fluid.

$$Q = \frac{m \times C \times (T_t - T_0)}{\Delta t}$$

$$= \frac{\rho \times V \times C \times \Delta T}{\Delta t}$$

$$= \frac{1 \times 60 \times 4.2 \times 12}{900}$$

$$= 3.36 \text{ [kJ/s]} \approx 3.4 \text{ [kW]}$$

Cooling capacity = Considering a safety factor of 20%,

$$3.4 \text{ [kW]} \times 1.2 = \boxed{4.08 \text{ [kW]}}$$

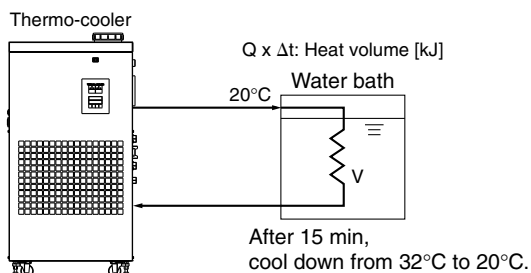

Note) This is the calculated value by changing the fluid temperature only.
 Thus, it varies substantially, depending on the water bath or piping shape.

Example of the conventional measurement units (Reference)

Heat dissipated by cooled substance (per unit time) Q : Unknown [kcal/h] → [kW]
 Cooled substance : Water
 Cooled substance weight m : (= ρ × V) [kgf]
 Cooled substance weight (volume ratio) γ : 1 [kgf/l]
 Total volume of the substance being cooled down V : 60 [l]
 Specific heat capacity of cooled substance C : 1.0 [kcal/(kgf·°C)]
 Temperature of cooled substance when cooling begins T₀ : 32 [°C]
 Cooled substance temperature after t hour T_t : 20 [°C]
 Cooling temperature difference ΔT : 12 [°C] (= T₀ - T_t)
 Cooling time Δt : 15 [min]
 Conversion factor: hours to minutes : 60 [min/h]
 Conversion factor: kcal/h to kW : 860 [(kcal/h)/kW]

$$Q = \frac{m \times C \times (T_t - T_0)}{\Delta t \times 860}$$

$$= \frac{\gamma \times V \times 60 \times C \times \Delta T}{\Delta t \times 860}$$

$$= \frac{1 \times 60 \times 60 \times 1.0 \times 12}{15 \times 860}$$

$$= \frac{2880 \text{ [kcal/h]}}{860} \approx 3.4 \text{ [kW]}$$

Cooling capacity = Considering a safety factor of 20%,

$$3.4 \text{ [kW]} \times 1.2 = \boxed{4.08 \text{ [kW]}}$$

Precautions on Model Selection

1. Heating capacity

If the circulating fluid is to be set at a higher temperature than room temperature, the circulating fluid will be heated due to heat generation of a pump in the Thermo-cooler. However, the Thermo-cooler has a lower heating capacity than a dedicated heater.

2. Pump capacity

<Circulating fluid flow>

Pump capacity varies depending on the model selected from the HRGC series. Also, circulating fluid flow varies depending on the circulating fluid discharge pressure. Consider the installation height difference between our cooler and a customer's equipment, and the piping resistance such as circulating fluid pipings, or piping size, or piping curves in the equipment. Confirm beforehand if the required flow is achieved using the pump capacity curves for each respective model.

<Circulating fluid discharge pressure>

Circulating fluid discharge pressure has the possibility to increase up to the maximum pressure in the pump capacity curves for the respective model. Confirm beforehand if the circulating fluid pipings or circulating fluid circuit of the customer's equipment are fully durable against this pressure.

Circulating Fluid Typical Physical Property Values

1. This catalog uses the following values for density and specific heat capacity in calculating the required cooling capacity.

Density ρ : 1 [kg/dm³]
 (or, using conventional unit system, weight: volume ratio γ = 1 [kgf/l])
 Specific heat capacity C : 4.19 [kJ/(kg·K)]
 (or, using conventional unit system of units, 1 [kcal/(kgf·°C)])

2. Values for density and specific heat capacity change slightly according to temperature as shown in the below table. Use this as a reference. Note)

Water

Physical property value Temperature	Density ρ [kg/dm ³]	Specific heat C [kJ/(kg·K)]	Conventional unit system	
			Weight: volume ratio γ [kgf/l]	Specific heat C [kcal/(kgf·°C)]
5°C	1.00	4.20	1.00	1.00
10°C	1.00	4.19	1.00	1.00
15°C	1.00	4.19	1.00	1.00
20°C	1.00	4.18	1.00	1.00
25°C	1.00	4.18	1.00	1.00
30°C	1.00	4.18	1.00	1.00
35°C	0.99	4.18	0.99	1.00

Aqueous Solution of 15% Ethylene Glycol

Physical property value Temperature	Density ρ [kg/l]	Specific heat C [kJ/(kg·K)]	Conventional unit system	
			Weight: volume ratio γ [kgf/l]	Specific heat C [kcal/(kgf·°C)]
5°C	1.02	3.91	1.02	0.93
10°C	1.02	3.91	1.02	0.93
15°C	1.02	3.91	1.02	0.93
20°C	1.01	3.91	1.01	0.93
25°C	1.01	3.91	1.01	0.93
30°C	1.01	3.91	1.01	0.94
35°C	1.01	3.92	1.01	0.94

Note) The above shown are reference values.

Please contact circulating fluid manufacturers for details.

Thermo-cooler Series HRGC



How to Order

HRGC 001 - A -

Cooling capacity

001	Cooling capacity: 0.9/1.1 kW (50/60 Hz)
002	Cooling capacity: 1.9/2.3 kW (50/60 Hz)
005	Cooling capacity: 4.5/4.8 kW (50/60 Hz)

Cooling method

A	Air-cooled refrigerator type
W	Water-cooled refrigerator type

Temperature stability

Nil	±1.0°C
5	±0.5°C

Option

Nil	None
B	With ground fault circuit interrupter
C	With communications function (RS-485)
S	With communications function (RS-232C)
E	With leakage breaker
H	With heater
J	With automatic water supply function
K	With external switch inlet
M	Stainless steel wetted part for circulating fluid
T	High-lift pump
Y	With DI control kit

* Refer to pages 9 to 12 for the specifications of each option.

Piping thread type

Nil	Rc
F	G (PT-G conversion fitting is included)
N	NPT (PT-NPT conversion fitting is included)

Options and Combinations

Symbol <small>Note 1)</small>	B	C	S	E	H	J	K	M	T	Y
Options <small>Note 2)</small>	With ground fault circuit interrupter	<small>Note 3)</small> With communications function (RS-485)	<small>Note 3) Note 5)</small> With communications function (RS-232C)	With water leakage sensor	<small>Note 4)</small> With heater	With automatic water supply function	<small>Note 5)</small> With external switch inlet	<small>Note 4)</small> Stainless steel wetted part for circulating fluid	High-lift pump	<small>Note 4)</small> With DI control kit
Size										
HRGC001-□ (Temperature stability ±1.0°C)	●	●	●	●	●	●	●	●	●	●
HRGC001-□5 (Temperature stability ±0.5°C)	●	●	●	●	—	●	●	—	●	—
HRGC002-□ (Temperature stability ±1.0°C)	●	●	●	●	●	●	●	●	●	●
HRGC002-□5 (Temperature stability ±0.5°C)	●	●	●	●	—	●	●	—	●	—
HRGC005-□ (Temperature stability ±1.0°C)	●	●	●	●	●	●	●	●	—	●
HRGC005-□5 (Temperature stability ±0.5°C)	●	●	●	●	—	●	●	—	—	—

Note 1) When multiple options are combined, display symbols in alphabetical order.

Note 2) Refer to pages 9 to 12 for details of options.

Note 3) Option C (with communications function (RS-485)) and option S (with communications function (RS-232C)) cannot be combined.

Note 4) Option M (stainless steel wetted part for circulating fluid) and option Y (with DI control kit) cannot be combined.

When combined with option H (with heater), circulating-fluid temperature will be between 5°C and 35°C.

Note 5) Option K (with external switch inlet) and option S (with communications function (RS-232C)) cannot be combined.

Series HRGC

Specifications (Refer to the product specifications for details.)

HRGC001, 002, 005

Model		HRGC001		HRGC002		HRGC005	
Cooling method		Air-cooled refrigeration	Water-cooled refrigeration	Air-cooled refrigeration	Water-cooled refrigeration	Air-cooled refrigeration	Water-cooled refrigeration
Refrigerant		R407C (HFC)					
Control method		Refrigerator ON/OFF control or Proportional valve PID control					
Ambient temperature/humidity <small>Note 1)</small>		Temperature: 5 to 40°C, Humidity: 30 to 70%RH					
Circulating fluid system	Circulating fluid <small>Note 2)</small>	Clear water, Deionized water, Aqueous solution of 15% ethylene glycol					
	Circulating method	For externally sealed circuit					
	Temperature range setting <small>Note 1)</small> °C	5 to 35					
	Cooling capacity <small>Note 3)</small> (50/60 Hz) kW	0.9/1.1 (at 20°C)	0.9/1.1 (at 20°C)	1.9/2.3 (at 20°C)	1.9/2.3 (at 20°C)	4.5/4.8 (at 20°C)	4.5/4.8 (at 20°C)
	Heating capacity <small>Note 4)</small> kW	—	—	—	—	—	—
	Temperature stability <small>Note 5)</small> °C	±1.0 (Refrigerator ON/OFF control), ±0.5 (Proportional valve PID control)					
	Pump capacity <small>Note 6)</small> (50/60 Hz) MPa	0.13/0.18 (at 10 ℓ/min)				0.21/0.32 (at 23 ℓ/28 ℓ/min)	
	Rated flow <small>Note 7)</small> (50/60 Hz) ℓ/min	10/10				23/28	
	Tank capacity ℓ	Approx. 10				Approx. 20	
	Port size	Rc1/2					
Wetted parts material	Stainless steel, PPE, PVC, Copper brazing (Heat exchanger), Bronze, Brass						
Facility water system	Temperature range °C	—	5 to 32	—	5 to 32	—	5 to 32
	Pressure range MPa	—	0.3 to 0.5	—	0.3 to 0.5	—	0.3 to 0.5
	Required flow rate <small>Note 8)</small> (50/60 Hz) ℓ/min	—	10/12	—	10/12	—	27/28
	Port size	—	Rc1/2	—	Rc1/2	—	Rc1/2
	Wetted parts material	Stainless steel, PVC, Copper brazing (heat exchanger), Bronze, Brass					
Electrical system	Power supply	Single-phase 200 to 230 VAC 50/60 Hz Allowable voltage fluctuation ±10%					
	Applicable ground fault circuit interrupter capacity <small>Note 9)</small> A	15		15		30	
	Maximum operating current A	8.1	7.8	8.6	8.0	17.2	14.1
	Rated power consumption <small>Note 11)</small> (50/60 Hz) kW	0.76/0.82	0.68/0.73	1.13/1.20	0.89/0.98	2.07/2.23	1.76/1.83
	Remote operation signal input	Relay contact input (operates when the switch is closed, stops when the switch is opened)					
	Operation signal output	Relay contact output (switch closed when operating, switch open when stopped, switch open when shut down)					
	Alarm stop signal output	Relay contact output (switch closed when alarm is turned off, switch open when alarm is turned on, switch closed when shut down)					
	Alarm	Refer to page 7.					
Weight <small>Note 10)</small> kg	75	75	75	75	110	110	

Note 1) It should have no condensation.

During seasons or in locations where the ambient temperature is likely to fall below freezing point, please consult SMC separately.

Note 2) If clear water is to be used, please use water that conforms to Clear Water Quality Standard of the Japan Refrigeration and Air Conditioning Industrial Association (JRA GL-02-1994 cooling water system - circulating type - make-up water).

Deionized water can be used only for supply water. Supply water with electrical conductivity of 1 μS/cm or more. (Electrical resistivity: 1 MΩ·cm or less) An optional DI control kit (symbol Y) is available to maintain electrical resistance. Refer to page 12 for details. If ethylene glycol aqueous solution is used, concentration must be 15%.

Note 3) ① Ambient temperature: 32°C, Facility water temperature: 25°C (water-cooled refrigeration), ② Circulating fluid temperature: 20°C,

③ Circulating fluid flow rate: Values at circulating fluid rated flow rate.

Note 4) Thermo-cooler specifications do not have heating capability.

(When heating capability is required, use a product with an optional heater (symbol H). Refer to page 9 for details.)

Note 5) Temperature at the Thermo-cooler outlet when the circulating fluid has a rated flow, and the facility water with the circulating fluid supply and return are directly connected. The installation environment, power supply and facility water should be stable within the specified range.

Note 6) Capacity of the Thermo-cooler outlet when the circulating fluid temperature is at 20°C.

Note 7) Required flow for cooling capacity or maintaining the temperature stability.

When used below the rated flow, open the standard manual by-pass valve and maintain a circulating fluid flow rate equivalent to the rated flow.

Also use the by-pass piping set sold separately.

Note 8) Required flow when a load is applied as shown in the cooling capacity when the facility water temperature is at 25°C.

Note 9) Purchase a ground fault circuit interrupter with current sensitivity of 30 mA separately. (Optional circuit breaker (symbol B) is also available. Refer to page 9.)

Note 10) Weight in the dry state, without circulating fluids.

Note 11) In case of refrigerator ON/OFF control. For other conditions, refer to Note 3).

Accessories (Enclosed)

Content	Applicable model
Eye bolts M12 (4 pcs.)	HRGC005
Y-type strainer (1 pc.)	Water-cooled type

• Eye bolts are included in HRGC005. (Not assembled)

• A Y-type strainer is included in the water cooled type. (Not assembled)

Cooling Capacity

HRGC001-A, HRGC001-W

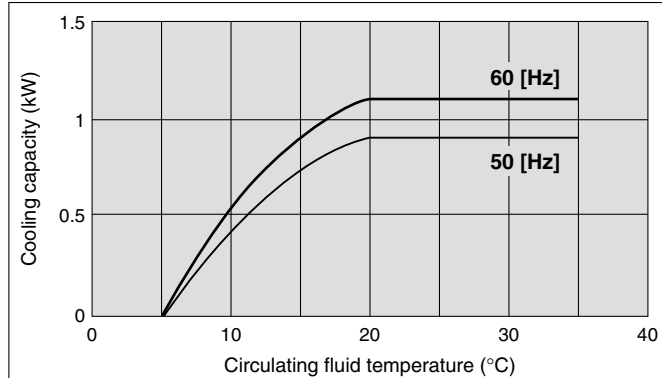

HRGC002-A, HRGC002-W

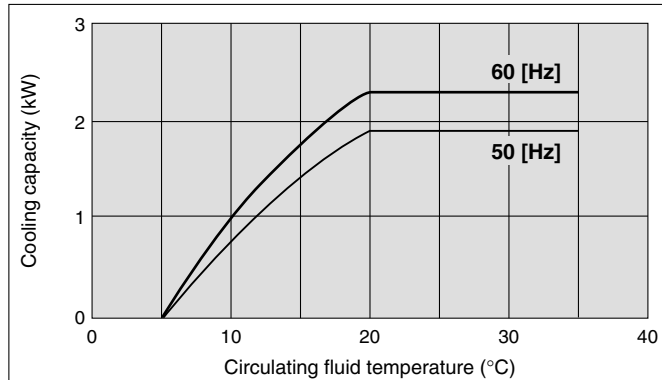

HRGC005-A, HRGC005-W

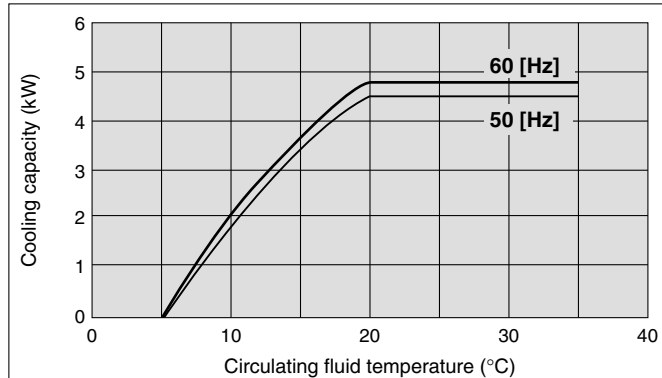

Pump Capacity

**HRGC001-A, HRGC001-W
HRGC002-A, HRGC002-W**

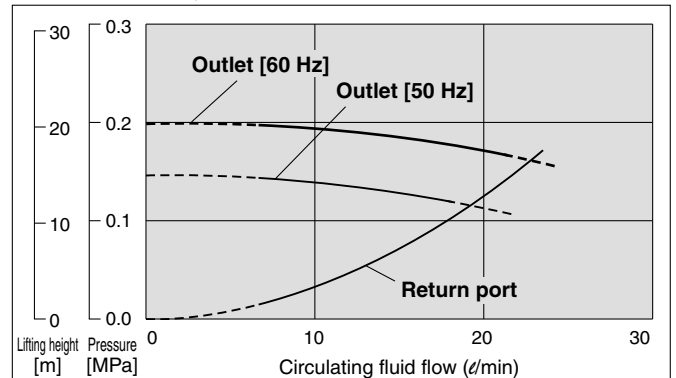

HRGC005-A, HRGC005-W

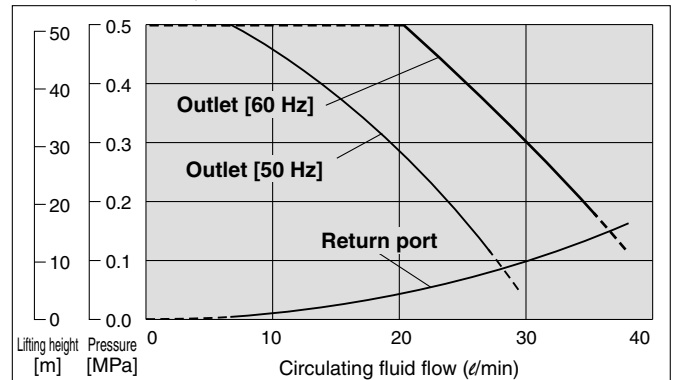

* For all common models, temperature stability will decline in the flow rate range where circulating fluid is deduced (dotted line).

Facility Water Flow Rate

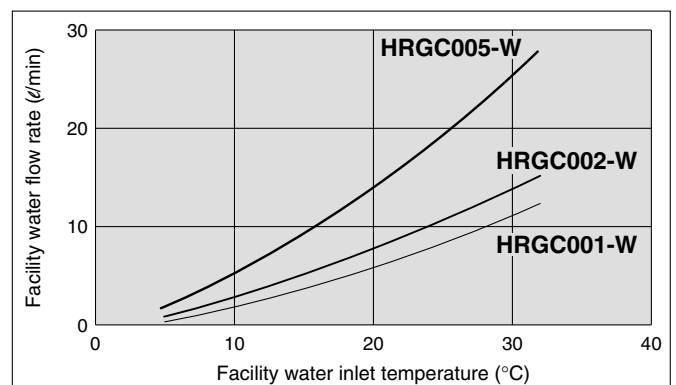

* This is the flow rate of facility water at the rated cooling capacity and circulating fluid flow, operating at 60 Hz.

Series HRGC

Dimensions: Air-Cooled Refrigeration

HRGC001-A□

HRGC002-A□

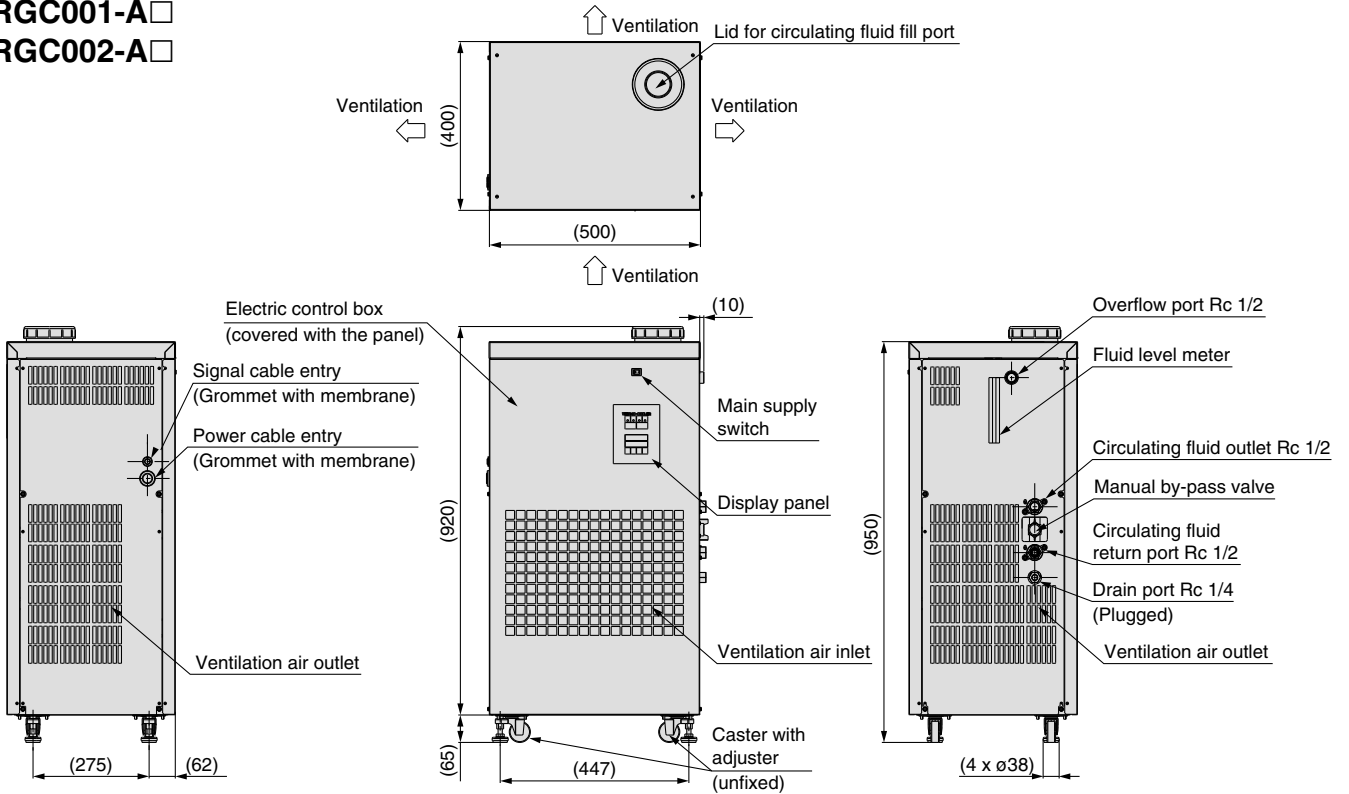

HRGC005-A□

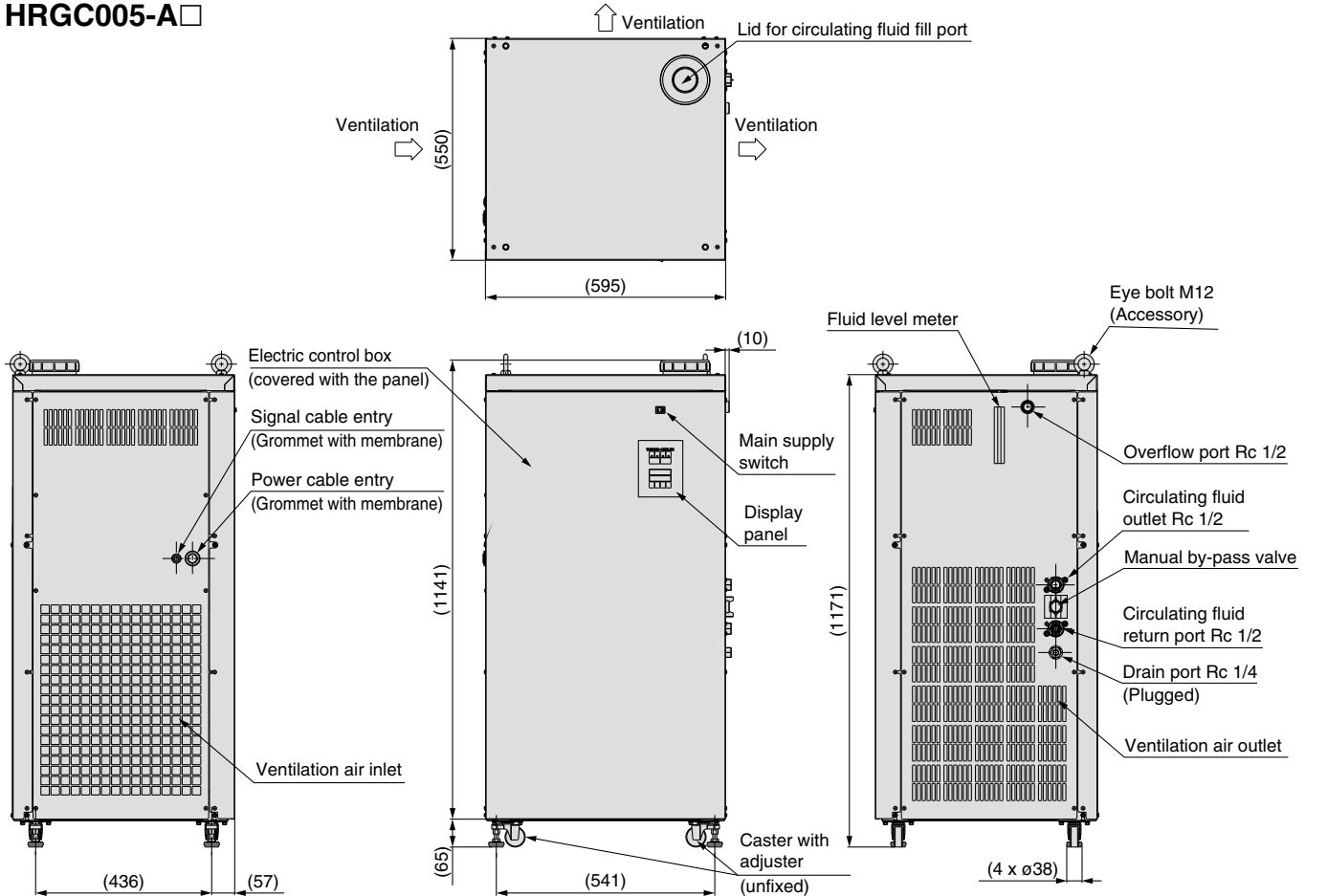

Eye bolts included. (Not assembled)

Dimensions: Water-Cooled Refrigeration

HRGC001-W□

HRGC002-W□

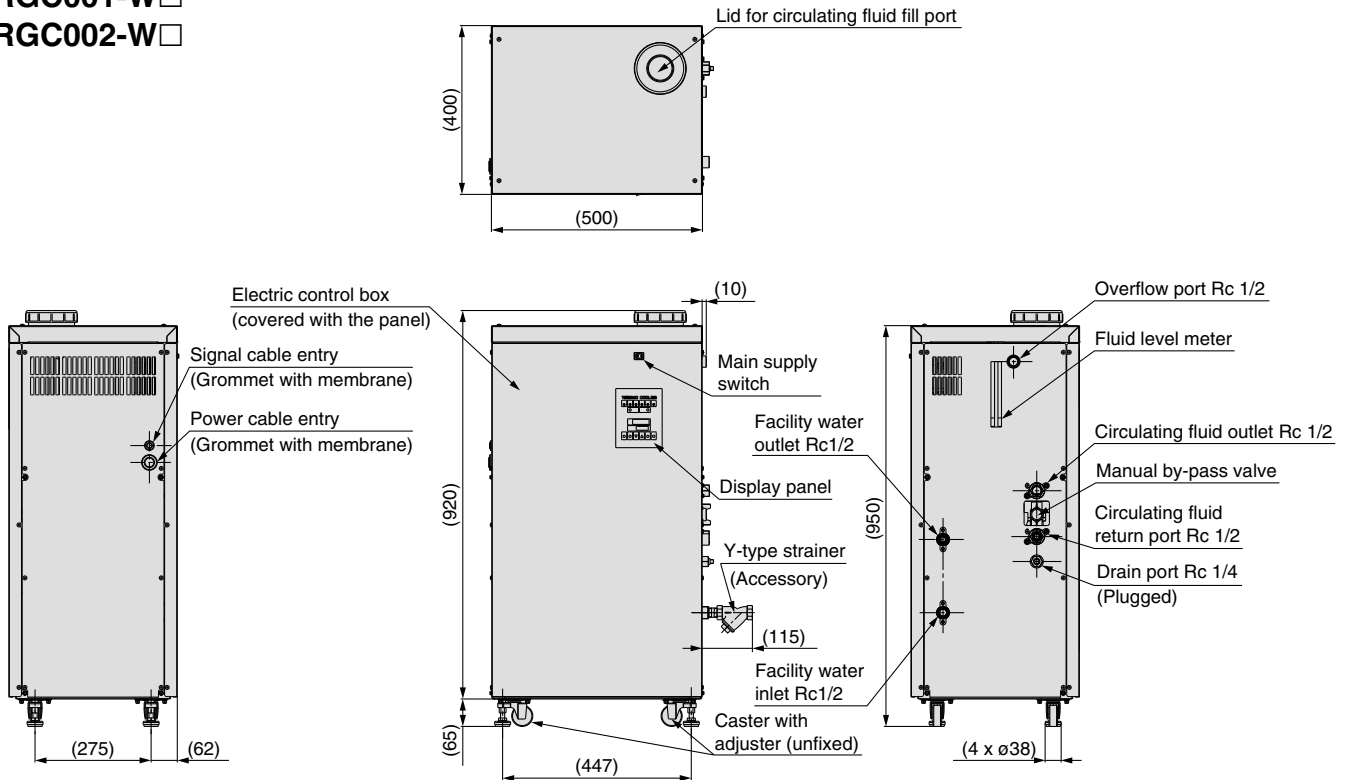

Y-type strainer included. (Not assembled)

HRGC005-W□

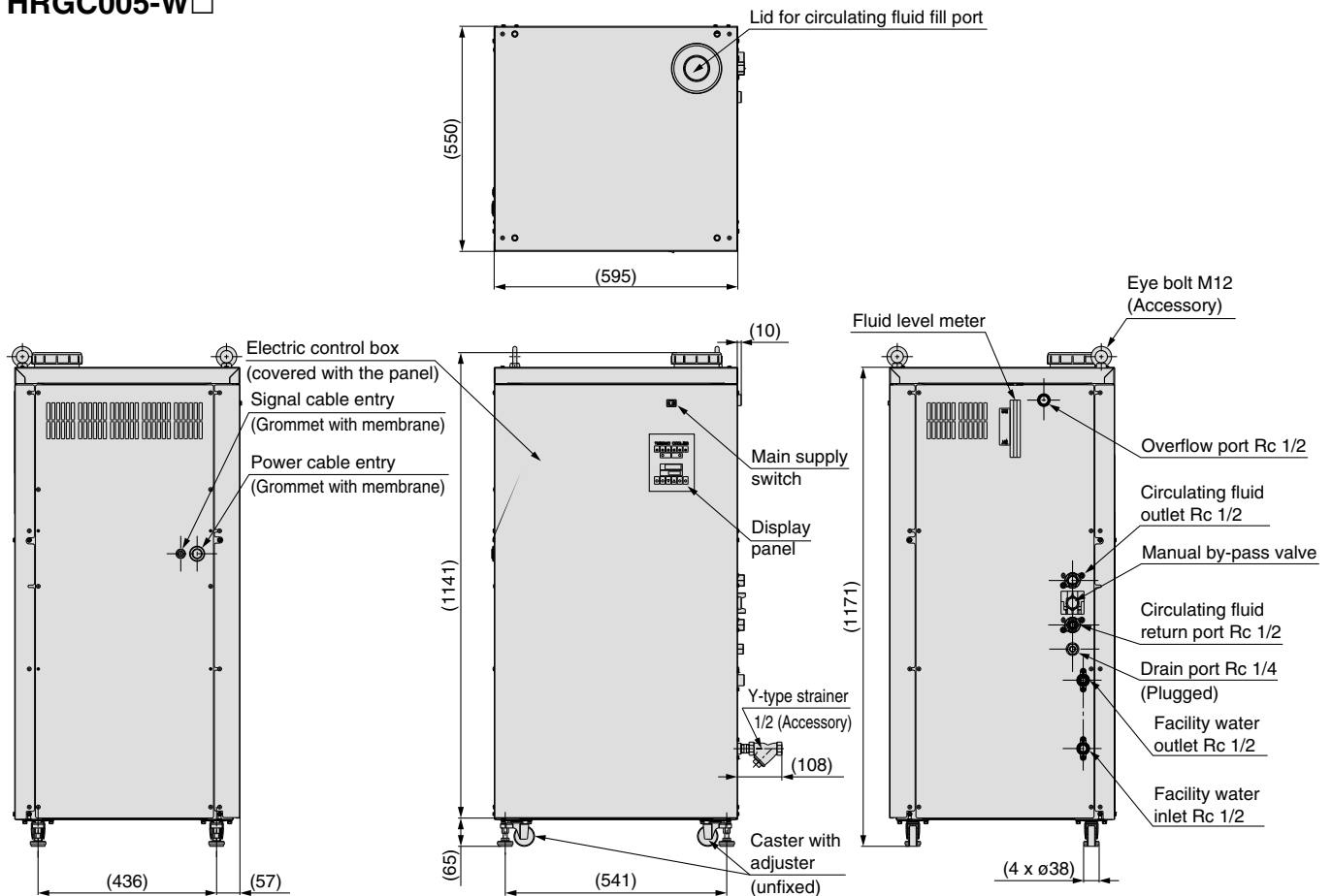

Y-type strainer and eye bolts included. (Not assembled)

Series HRGC

Piping Connection and Installation Dimensions

HRGC001, HRGC002

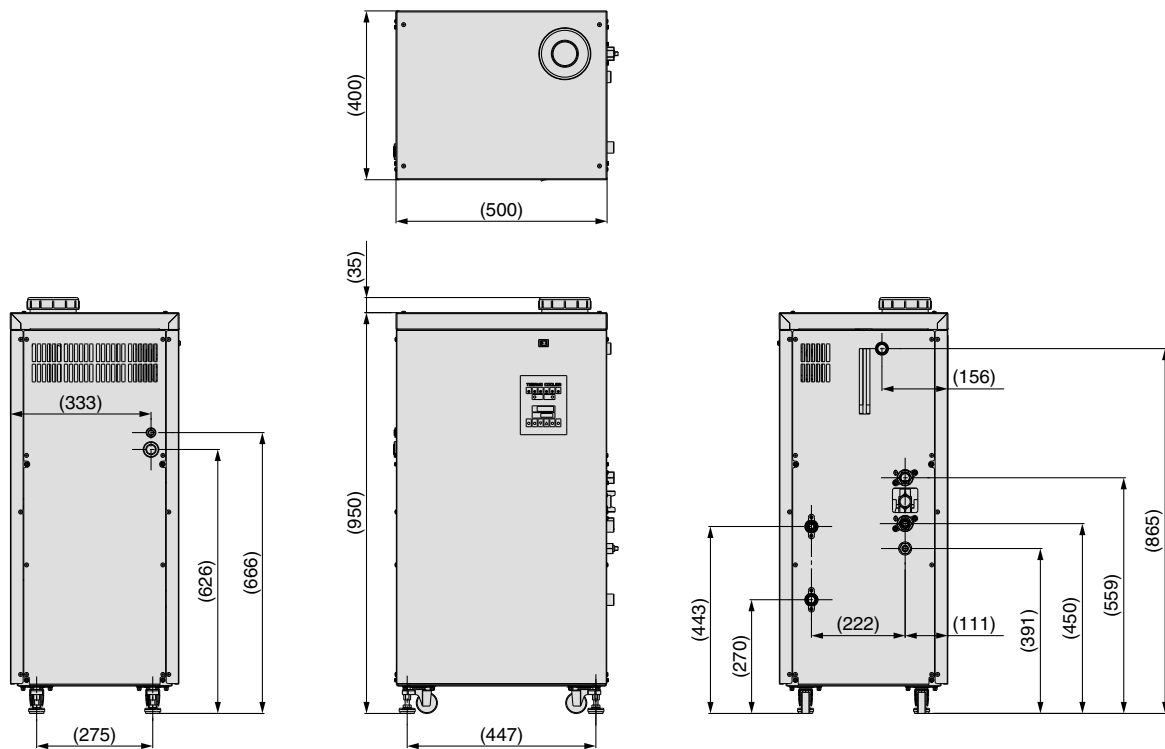

* Example figure: HRGC001-W

HRGC005

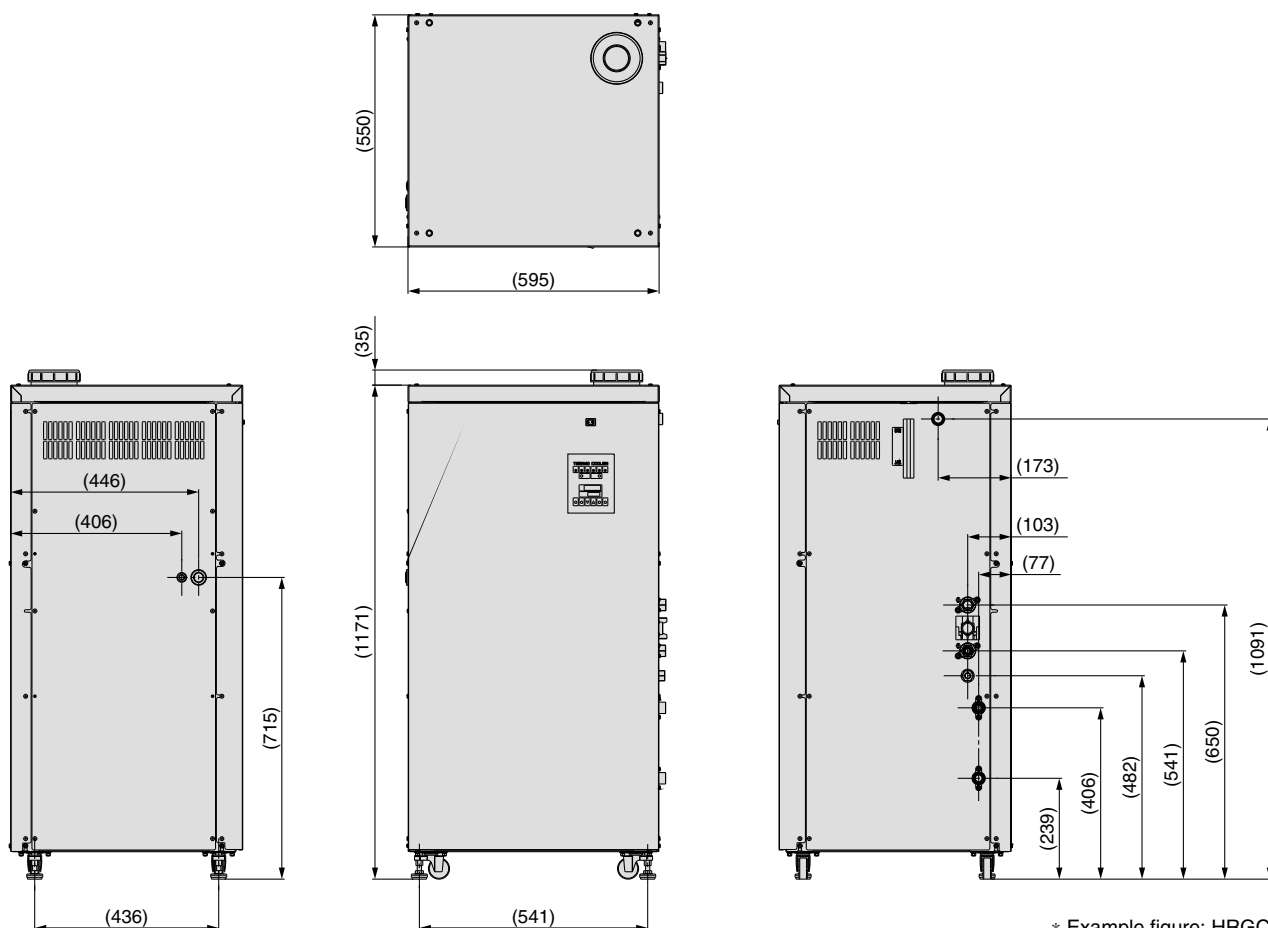

* Example figure: HRGC005-W

Operation Panel Display

HRGC001, HRGC002, HRGC005

The basic operation of the this product is performed on the front operation display panel. This operation display panel is common to all models.

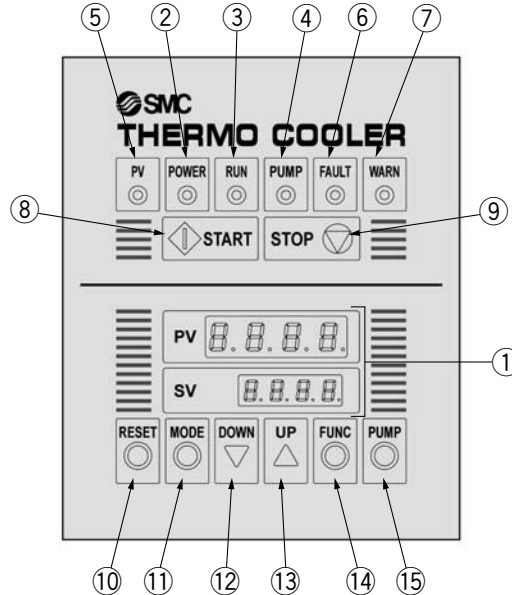

No.	Description	Function	
①	Digital display PV/SV	PV	Displays the circulating fluid temperature. Displays the alarm code when an alarm is active.
		SV	Displays the set temperature of the circulating fluid.
②	[POWER] indicator	Lights up when the power is supplied.	
③	[RUN] indicator	Lights up when the [START] key is pressed.	
④	[PUMP] indicator	Lights up when the pump is running.	
⑤	[PV] indicator	Lights up when the circulating fluid temperature is displayed.	
⑥	[FAULT] indicator	Lights up when the emergency error occurs, and stops the operation.	
⑦	[WARN] indicator	Lights up when the warning error occurs, and continues the operation.	
⑧	[START] key	Starts the operation.	
⑨	[STOP] key	Stops the operation.	
⑩	[RESET] key	Resets the alarm.	
⑪	[MODE] key	Changes settings such as the offset function, etc.	
⑫	[DOWN] key	Decreases the set temperature.	
⑬	[UP] key	Increases the set temperature.	
⑭	[FUNC] key	Changes the display between the circulating fluid temperature and optional functions.	
⑮	[PUMP] key	Operates the pump independently while pressed.	

Alarm/Alarm Indicators and Explanations of Alarms

The 6 basic temperature controller alarms are displayed on the PV of the operation display panel with their alarm codes, as well as the fault (FAULT) indicator (red LED) and warning (WARN) indicator (yellow LED).

When the source of the problem has been eliminated, the equipment must be restarted.

■ Explanations of Alarms (HRGC001/002/005)

Indicator	Alarm	Operation status	Main reason
[FAULT]	Low level of fluid in tank	Stop	Level switch activated because fluid level in tank fell below LOW.
	Rise in coolant pressure	Stop	Pressure switch activated because inadequate heat dissipation caused refrigerant pressure to rise.
	Circulating fluid temperature abnormally high	Stop	Temperature sensor activated because circulating fluid temperature became too high. (fixed at 40°C)
	Overload of pump	Stop	Circulation pump overload relay activated.
	Overload of refrigerator	Stop	Refrigerator overload relay activated.
[FAULT/WARN]	Abnormal circulating fluid temperature	Stop/Continue operation	Circulating fluid temperature is out of the customer's preset range.

Series HRGC

Contact Input/Output Function

The thermo-cooler is standard-equipped with terminals that allow remote start/stop, and enable output of an operation signal, abnormal status stop signal or alarm signal. These should be used for synchronizing startup and shutdown with your other equipment, or when adding new warning lights or buzzers. However, the contact output volume is limited, so please add warning lights and/or buzzers for special relays (for amplification) if they are necessary.

Item		Specifications		
		HRGC001	HRGC002	HRGC005
Connector type		M3 terminal block		
Remote operation signal input	Signal type	Relay contact input (Remote start when the contact signal is closed, Remote stop when the contact signal is open.)		
	Input voltage range	24 VDC±10% (Power supply is provided on the Thermo-cooler side.)		
	Input current	Max. 35 mA		
	Terminal number	1 (24 VDC), 2 (24 VCOM)		
Abnormal status stop signal output	Signal type	Relay contact output (When fault error (FAULT) occurs: open)		
	Contact capacity	250 VAC, 1 A (Resistance load)		
	Terminal number	3, 4		
Operation signal output	Signal type	Relay contact output (When operating: closed)		
	Contact capacity	250 VAC, 1 A (Resistance load)		
	Terminal number	5, 6		
Warning signal output	Signal type	Relay contact output (When warning error (WARN) occurs: open)		
	Contact capacity	250 VAC, 1 A (Resistance load)		
	Terminal number	7, 8		
Communications function (RS-485) (Note)	Communication standard	EIA standard RS-485 compliant		
	Information orientation	Half duplex		
	Synchronization method	Asynchronous communication		
	Terminal number	9, 10		
Circuit diagram		<p>24 VDC Thermo-cooler side ← → Customer's equipment side</p> <p>24 VCOM 3.9 kΩ</p> <p>Internal circuit</p> <p>Internal circuit</p> <p>Internal circuit</p> <p>Internal circuit</p> <p>Terminal block (14 poles)</p> <p>1 Remote operation signal input (Contact signal closed: chiller operation)</p> <p>2</p> <p>3 Abnormal status stop signal output (When fault error (FAULT) occurs: open)</p> <p>4</p> <p>5 Operation signal output (When operating: closed)</p> <p>6</p> <p>7 Alarm signal output (When warning error (WARN) occurs: open)</p> <p>8</p> <p>9 SD+ Communications function (RS-485)</p> <p>10 SD-</p>		

Note) Serial communication is optional. Refer to "Options" on page 9.

Input/output signal connection location

Remove the front panel, and connect a signal cable to the terminal block inside the electrical component enclosure.

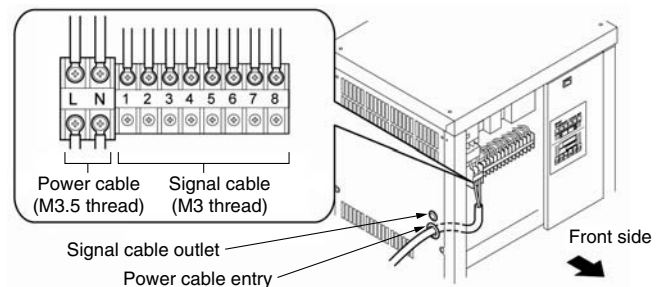

Other Features

Anti-freezing function

This function detects the circulating fluid temperature. If the temperature approaches freezing point, e.g. in winter at night, the pump operates automatically and the heat generated by the pump warms the circulating fluid, preventing freezing.

Series HRGC Options

Note) Options have to be selected when ordering the Thermo-cooler. It is not possible to add them after purchasing the unit.

B Option symbol

With Ground Fault Circuit Interrupter

HRGC - **B**

With ground fault circuit interrupter

In the event of a short circuit, overcurrent or overheating, the ground fault circuit interrupter will automatically shut off the power supply.

Breaker mounting location

Remove the front panel. The ground fault circuit interrupter is mounted inside the electrical component enclosure.

Option combination (○: Available, ×: Not available, ●: Possible, but specification needs to be modified partially.)

Symbol	5	B	C	E	H	J	K	M	S	T	Y
Options	Temperature stability ±0.5°C	With ground fault circuit interrupter	With communications function (RS-485)	With water leakage sensor	With heater	With automatic water supply function	With external switch inlet	Stainless steel wetted part for circulating fluid	With communications function (RS-232C)	High-lift pump	With DI control kit
Combination possibility with options	○	○	○	○	●	○	○	○	○	●	○

Applicable model	HRGC001- <input type="checkbox"/> <input type="checkbox"/> -B	HRGC002- <input type="checkbox"/> <input type="checkbox"/> -B	HRGC005- <input type="checkbox"/> <input type="checkbox"/> -B
Pole number	2		
Rated current sensitivity (mA)	30		
Rated shutdown current (A)	15/20 (Note)		30
Short circuit display method	Mechanical button		

Note) When option H or T is included.

C Option symbol

With Communications Function (RS-485)

HRGC - **C**

With communications function (RS-485)

The communications function allows you to set (write) or monitor (read) the circulating fluid temperature.

<Writing> Circulating fluid temperature setting (SV)
<Readout> Circulating fluid present temperature (PV)
Circulating fluid temperature setting (SV)

Communication connection location

Remove the front panel, and connect your communication cable to the terminal block mounted inside the electrical component enclosure.

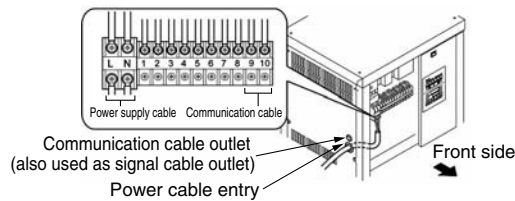

Option combination (○: Available, ×: Not available, ●: Possible, but specification needs to be modified partially.)

Symbol	5	B	C	E	H	J	K	M	S	T	Y
Options	Temperature stability ±0.5°C	With ground fault circuit interrupter	With communications function (RS-485)	With water leakage sensor	With heater	With automatic water supply function	With external switch inlet	Stainless steel wetted part for circulating fluid	With communications function (RS-232C)	High-lift pump	With DI control kit
Combination possibility with options	○	○	○	○	○	○	○	○	×	○	○

Applicable model	HRGC001- <input type="checkbox"/> <input type="checkbox"/> -C	HRGC002- <input type="checkbox"/> <input type="checkbox"/> -C	HRGC005- <input type="checkbox"/> <input type="checkbox"/> -C
Connector no.	9 (SD+), 10 (SD-)		
Connector type (on this product side)	M3 terminal block		
Standards	EIA standard RS-485 compliant		
Protocol	Special protocol: For details, refer to the Communications Specifications document.		

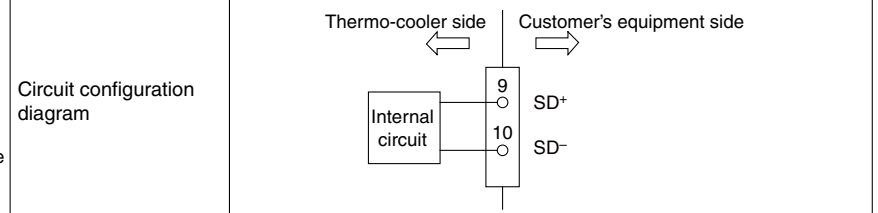

E Option symbol

With Water Leakage Sensor

HRGC - **E**

With water leakage sensor

This built-in water leakage sensor can detect fluid leakage in the product and stop its operation.

Option combination (○: Available, ×: Not available, ●: Possible, but specification needs to be modified partially.)

Symbol	5	B	C	E	H	J	K	M	S	T	Y
Options	Temperature stability ±0.5°C	With ground fault circuit interrupter	With communications function (RS-485)	With water leakage sensor	With heater	With automatic water supply function	With external switch inlet	Stainless steel wetted part for circulating fluid	With communications function (RS-232C)	High-lift pump	With DI control kit
Combination possibility with options	○	○	○	○	○	○	○	○	○	○	○

Applicable model	HRGC001- <input type="checkbox"/> <input type="checkbox"/> -E	HRGC002- <input type="checkbox"/> <input type="checkbox"/> -E	HRGC005- <input type="checkbox"/> <input type="checkbox"/> -E
Water leakage detection method	Infrared reflection		
Water leakage detectable amount (l)	1 l or more		
Protection function	Activates if water leaks in the product or an abnormal stop occurs		

H Option symbol

With Heater

HRGC - **H**

With heater

This built-in heater can heat up circulating fluid and adjust it at high temperatures.

It can raise the circulating-fluid temperature quickly, even when the initial temperature is low in winter. It can be also used to heat the fluid.

Option combination (○: Available, ×: Not available, ●: Possible, but specification needs to be modified partially.)

Symbol	5	B	C	E	H	J	K	M	S	T	Y
Options	Temperature stability ±0.5°C	With ground fault circuit interrupter	With communications function (RS-485)	With water leakage sensor	With heater	With automatic water supply function	With external switch inlet	Stainless steel wetted part for circulating fluid	With communications function (RS-232C)	High-lift pump	With DI control kit
Combination possibility with options	×	○	○	○	○	○	○	●	○	○	●

Applicable model	HRGC001- <input type="checkbox"/> -H	HRGC002- <input type="checkbox"/> -H	HRGC005- <input type="checkbox"/> -H
Heater capacity	0.6 kW		
Temperature control method	Proportional valve PID control, heating and cooling control of heater P control, or refrigerator and heater ON/OFF control (Note 1)		
Temperature setting range	5 to 60°C or 5 to 35°C (Note 1)		5 to 35°C
Temperature stability	±1.0°C (Note 2)		
Protection function	Thermal fuse		

Note 1) When selecting option M or option Y

Note 2) Temperature stability ±0.5°C specifications cannot be selected.

Series HRGC

J Option symbol With Automatic Water Supply Function

HRGC ---**J**
 ● With automatic water supply function

By installing this at the automatic water supply inlet, circulating fluid can be easily supplied to the product using a built-in ball tap for water supply.

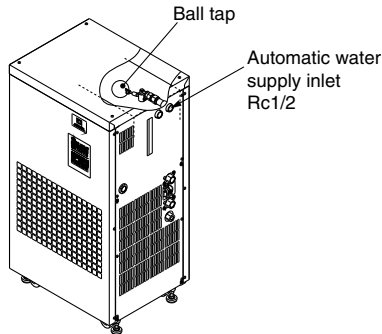

Option combination (○: Available, ×: Not available, ●: Possible, but specification needs to be modified partially.)

Symbol	5	B	C	E	H	J	K	M	S	T	Y
Options	Temperature stability ±0.5°C	With ground fault circuit interrupter	With communications function (RS-485)	With water leakage sensor	With heater	With automatic water supply function	With external switch inlet	Stainless steel wetted part to circulating fluid	With communications function (RS-232C)	High-lift pump	With DI control kit
Combination possibility with options	○	○	○	○	○	○	○	○	○	○	○

Applicable model	HRGC001- <input type="checkbox"/> - <input type="checkbox"/> - J	HRGC002- <input type="checkbox"/> - <input type="checkbox"/> - J	HRGC005- <input type="checkbox"/> - <input type="checkbox"/> - J
Water supply method	Built-in ball tap for automatic water supply		
Water supply pressure (MPa)	0.2 to 0.5		
Water supply capacity (l/min)	2 or more (at 0.2 MPa)		

K Option symbol With External Switch Inlet

HRGC ---**K**
 ● With external switch inlet

This can supply power to external switches (flow switch, etc.) for alarms, and send signals indicating abnormalities from the switch to the product.

If an abnormality signal is input from the external switch, the product will respond as follows:

- The product will continue operating (if already in operation).
- Alarm light turns on.
- Alarm signal is output.
- Alarm is displayed.

Option combination (○: Available, ×: Not available, ●: Possible, but specification needs to be modified partially.)

Symbol	5	B	C	E	H	J	K	M	S	T	Y
Options	Temperature stability ±0.5°C	With ground fault circuit interrupter	With communications function (RS-485)	With water leakage sensor	With heater	With automatic water supply function	With external switch inlet	Stainless steel wetted part to circulating fluid	With communications function (RS-232C)	High-lift pump	With DI control kit
Combination possibility with options	○	○	○	○	○	○	○	○	×	○	○

Applicable model	HRGC001- <input type="checkbox"/> - <input type="checkbox"/> - K	HRGC002- <input type="checkbox"/> - <input type="checkbox"/> - K	HRGC005- <input type="checkbox"/> - <input type="checkbox"/> - K
External switch signal input	Contact input or PNP open collector input (voltage at OFF: 24 VDC; current at ON: 35 mA or less)		
External switch power output	Power supply voltage 24 VDC ±10% 5 W to 20 W		

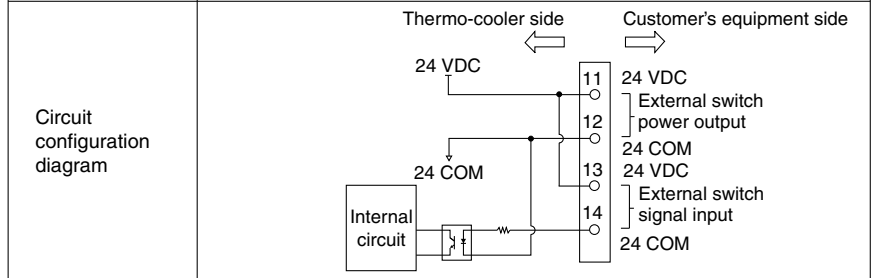

Wiring Connection Location

Remove the front panel, and connect your communication cable to the terminal block mounted inside the electrical component enclosure.

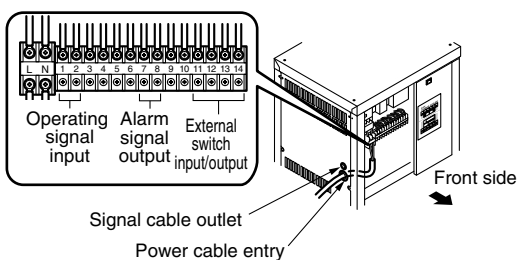

Application examples

When monitoring flow with a flow-rate switch

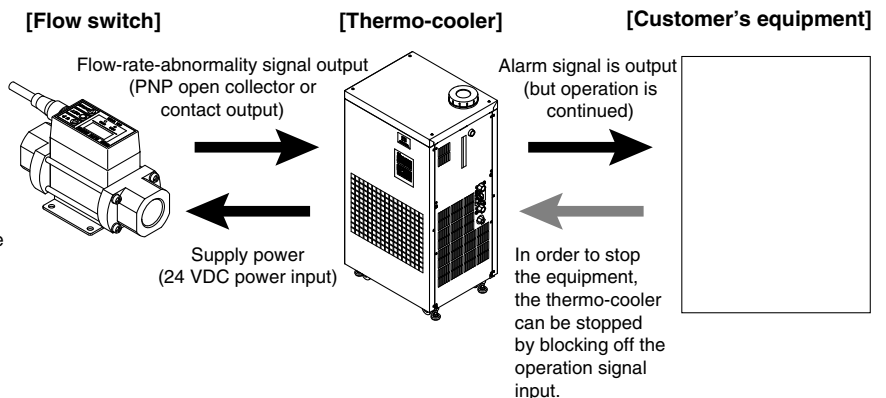

M Option symbol **Stainless Steel Wetted Part for Circulating Fluid**

HRGC - - - **M**

● **Stainless steel wetted part for circulating fluid**

By changing the material of the wetted part in the circulating-fluid circuit to stainless steel, deionized water with 2 MΩ or less of electrical resistance (0.5 μS/cm or more of electric conductivity) can be used. (However, heat exchanger is made of copper brazing.)

Option combination (○: Available, ×: Not available, ●: Possible, but specification needs to be modified partially.)

Symbol	5	B	C	E	H	J	K	M	S	T	Y
Options	Temperature stability ±0.5°C	With ground fault circuit interrupter	With communications function (RS-485)	With water leakage sensor	With heater	With automatic water supply function	With external switch inlet	Stainless steel wetted part for circulating fluid	With communications function (RS-232C)	High-lift pump	With DI control kit
Combination possibility with options	×	○	○	○	●	○	○	○	○	○	×

Applicable model	HRGC001- <input type="checkbox"/> -M	HRGC002- <input type="checkbox"/> -M	HRGC005- <input type="checkbox"/> -M
Temperature setting range	5 to 35°C Note 1)		
Temperature stability	±1.0°C Note 2)		
Circulating-fluid type	Clear water, Deionized water Note 3), Aqueous solution of 15% ethylene glycol		
Wetted part material for circulating fluid	Stainless steel, Copper brazing (Heat exchanger), PVC		

Note 1) This cannot be used in circulating-fluid temperatures of 35°C or higher, even when option H is selected.

Note 2) Temperature stability ±0.5°C specifications cannot be selected.

Note 3) Use deionized water with electrical resistance 2 MΩ·cm or less (electrical conductivity 0.5μS/cm or more).

S Option symbol **With Communications Function (RS-232C)**

HRGC - - - **S**

● **With communications function (RS-232C)**

With a host PC programmed in accordance with your manufacturing processor method, the communications function allows you to set (write) or monitor (read) the circulating fluid temperature.

<Writing> Circulating fluid temperature setting (SV)

<Readout> Circulating fluid present temperature (PV)
Circulating fluid temperature setting (SV)

Communication connection location

Remove the front panel, and connect your communication cable to the terminal block mounted inside the electrical component enclosure.

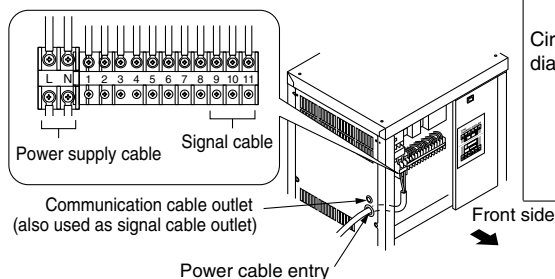

Option combination (○: Available, ×: Not available, ●: Possible, but specification needs to be modified partially.)

Symbol	5	B	C	E	H	J	K	M	S	T	Y
Options	Temperature stability ±0.5°C	With ground fault circuit interrupter	With communications function (RS-485)	With water leakage sensor	With heater	With automatic water supply function	With external switch inlet	Stainless steel wetted part for circulating fluid	With communications function (RS-232C)	High-lift pump	With DI control kit
Combination possibility with options	○	○	×	○	○	○	×	○	○	○	○

Applicable model	HRGC001- <input type="checkbox"/> -S	HRGC002- <input type="checkbox"/> -S	HRGC005- <input type="checkbox"/> -S
Connector no.	9 (RD), 10 (SD), 11 (SG)		
Connector type (on this product side)	M3 terminal block		
Standards	EIA standard RS-232C compliant		
Protocol	Special protocol: For details, refer to the Communications Specifications document.		

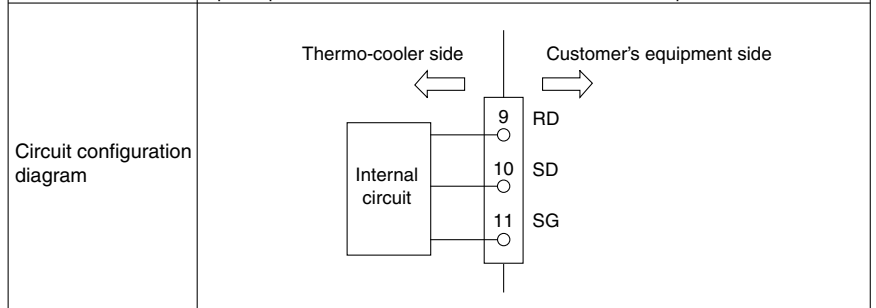

Series HRGC

T Option symbol High-lift Pump

HRGC - - - T
 High-lift pump

Possible to choose a high-lift pump in accordance with customer's piping resistance. Cooling capacity may decrease by heat generated in the pump (For HRGC005 as standard).

Option combination (○: Available, ×: Not available, ●: Possible, but specification needs to be modified partially.)

Symbol	5	B	C	E	H	J	K	M	S	T	Y
Options	Temperature stability $\pm 0.5^{\circ}\text{C}$	With ground fault circuit interrupter	With communications function (RS-485)	With water leakage sensor	With heater	With automatic water supply function	With external switch inlet	Stainless steel wetted part to circulating fluid	With communications function (RS-232C)	High-lift pump	With DI control kit
Combination possibility with options	×	●	○	○	○	○	○	○	○	○	○

Applicable model	HRGC001-□-T	HRGC002-□-T	HRGC005-□-T
Cooling capacity (50/60 Hz)	0.6/0.6 kW (Note)		1.6/1.8 kW (Note)
Pump capacity (50/60 Hz)	0.31/0.41 MPa (at 18/22 ℓ/min)		

Note) Cooling capacity may decrease as pump power increases.

Pump Capacity

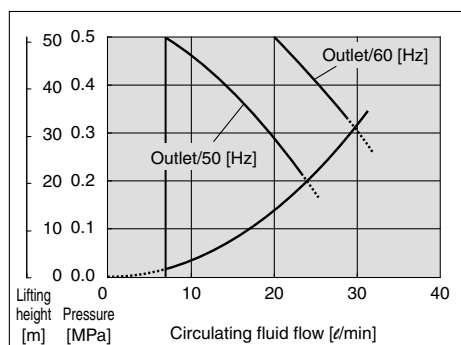

Cooling Capacity

HRGC001-□-T

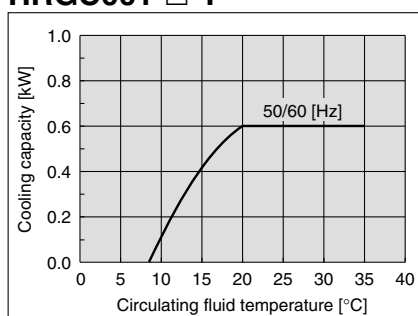

HRGC002-□-T

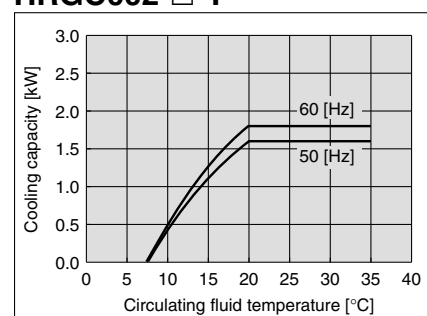

Y Option symbol With DI Control Kit

HRGC - - - Y
 With DI control kit

This option adds a function to control the electrical resistance of circulating fluid to the stainless steel wetted part for the fluid. By using this with a DI (Deionized water) filter (sold separately), the electrical resistance of the circulating fluid can be maintained at a constant level.

Option combination (○: Available, ×: Not available, ●: Possible, but specification needs to be modified partially.)

Symbol	5	B	C	E	H	J	K	M	S	T	Y
Options	Temperature stability $\pm 0.5^{\circ}\text{C}$	With ground fault circuit interrupter	With communications function (RS-485)	With water leakage sensor	With heater	With automatic water supply function	With external switch inlet	Stainless steel wetted part to circulating fluid	With communications function (RS-232C)	High-lift pump	With DI control kit
Combination possibility with options	×	○	○	○	●	○	○	×	○	○	○

Applicable model	HRGC001-□-Y	HRGC002-□-Y	HRGC005-□-Y
Temperature setting range	5 to 35 $^{\circ}\text{C}$ (Note 1)		
Temperature stability	$\pm 1.0^{\circ}\text{C}$ (Note 2)		
Circulating-fluid type	Clear water, Deionized water (Note 3), Aqueous solution of 15% ethylene glycol		
Material of wetted part for circulating fluid	Stainless steel, Copper brazing (heat exchanger), PVC		
DI display range	0 to 20 $\text{M}\Omega\text{-cm}$ (Note 3)		
DI setting range	0.00 to 2.00 $\text{M}\Omega\text{-cm}$ (Note 4)		
DI circuit rated flow	1.5 ℓ/min		
DI alarm	Max. DI level, Min. DI level, Selectable from Max. to Min.		
DI alarm operation	Can choose whether to stop or continue operation when alarm activates		

Note 1) This cannot be used in circulating-fluid temperatures of 35 $^{\circ}\text{C}$ or higher, even when option H is selected.

Note 2) Temperature stability $\pm 0.5^{\circ}\text{C}$ specifications cannot be selected.

Note 3) Use deionized water with 2 $\text{M}\Omega\text{-cm}$ or less of electrical resistance. (electric conductivity: 0.5 μS or more)

Note 4) The DI filter is needed to control the DI level. (SMC Part No.: HRZ-DF001) Please purchase additionally because the DI (Deionized water) filter is not included in this option.

*Install the DI (Deionized water) filter outside the thermo-chiller for piping. Secure the space for installing the DI (Deionized water) filter on the rear side of the Thermo-cooler.
 *It may go outside of the temperature stability range of $\pm 1.0^{\circ}\text{C}$ when this option is used in some operating conditions.

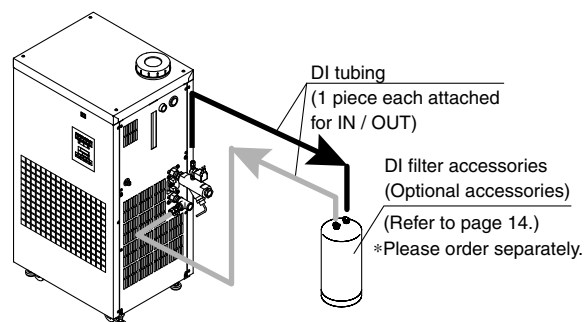

Note) Please order separately.
Necessary to be fitted
by the customer.

Dustproof Filter Set

Prevents performance degradation when using air-cooled refrigeration Thermo-coolers in dusty or contaminated environments.

- Maximum ambient temperature: 40°C

How to Order

HRGC-FL

Applicable Thermo-coolers

Symbol	Applicable Thermo-coolers	Quantity per set
001	HRGC001-A□ HRGC002-A□	1
005	HRGC005-A□	1

Dimensions

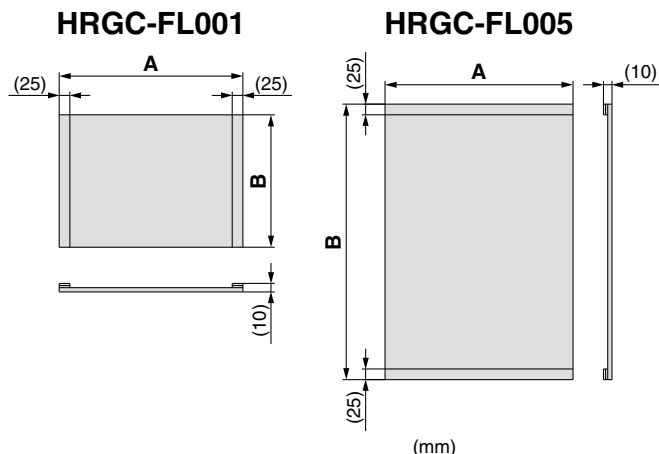

Part no.	A	B	Quantity per set
HRGC-FL001	475	310	1
HRGC-FL005	430	530	1

Mounting Example

- ① This dustproof filter is secured with hook-and-loop tape. This is sewed onto the male side of the surface fastener, and has adhesive tape backing for fixing to the female side.
- ② Remove the paper covering of the adhesive tape and affix the loop tape to the external panel of the ventilation hole on the Thermo-cooler.
- ③ Simply press the hook tape on to the loop tape to mount the dustproof filter.

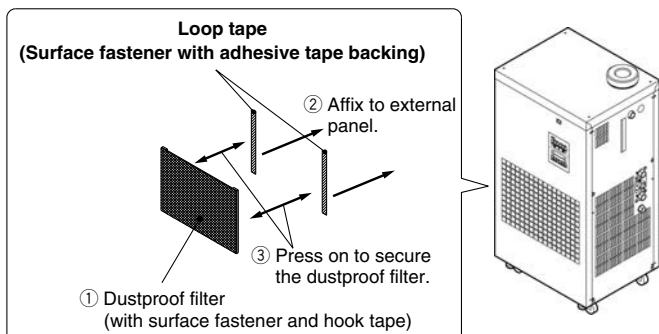

By-pass Piping Set

This prevents the occurrence of pump overload that exceeds the maximum operating pressure of the Thermo-cooler at low flow rate.

- Use circulating fluid in 5 to 60°C temperature range

How to Order

HRGC-BP

Applicable Thermo-coolers

Symbol	Applicable Thermo-coolers	Wetted part material	Pressure setting range (50/60 Hz) ^{Note)}
001	HRGC001-□ HRGC002-□	Bronze, PTFE, Stainless steel	0.12 to 0.13/ 0.16 to 0.18 MPa
001G	HRGC001-□ HRGC002-□	PTFE, Stainless steel	
005	HRGC005-□ HRGC00□-□-T	Bronze, PTFE, Stainless steel	0.22 to 0.48/ 0.29 to 0.48 MPa
005G	HRGC005-□ HRGC00□-□-T	PTFE, Stainless steel	

Note) The pressure of the by-pass piping set can be adjusted by the customer.

Dimensions

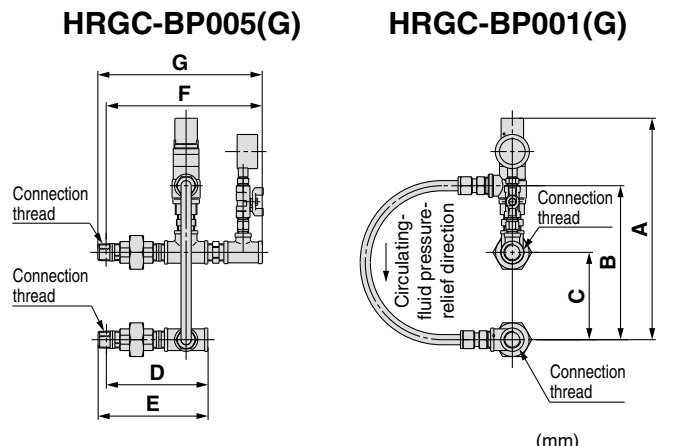

Part no.	A	B	C	D	E	F	G
HRGC-BP001(G)	275	195	110	130	140	200	210
HRGC-BP005(G)	300	210	110	130	140	200	210

Mounting Example

A pressure relief valve and pressure gauge can be mounted on the body with unions and nipples.

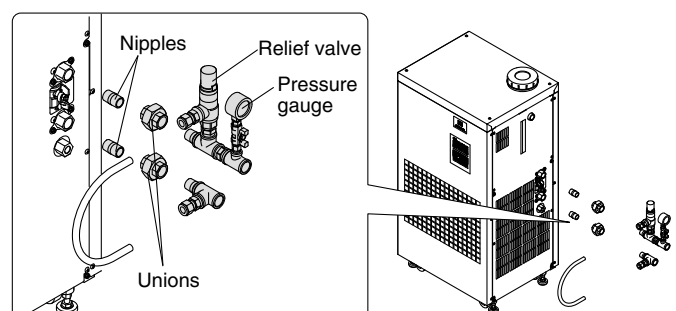

Note) Please order separately.
Necessary to be fitted
by the customer.

DI (Deionized Water) Filter

This is the ion replacement resin to maintain the electrical resistivity of the circulating fluid.

Customers who selected the DI control kit (Option "Y") need to purchase the DI (Deionized water) filter separately.

Part no.	Applicable model
HRZ-DF001	Common for all models which can select the DI control kit. (Option "Y")

Note) The DI (Deionized Water) filters are consumable. Depending on the status (electrical resistivity set value, circulating fluid temperature, piping volume, etc.), product life cycles will vary accordingly.

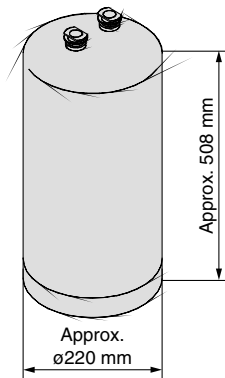

Weight: Approx. 20 kg

Insulating Material for DI (Deionized Water) Filter

When the DI (Deionized Water) filter is used at a high-temperature, we recommend that you use this insulating material to protect the radiated heat from the DI (Deionized Water) filter or possible burns. When the DI filter is used at a low-temperature, we also recommend that you use this to prevent heat absorption from the DI filter and to avoid forming condensation.

Part no.	Applicable model
HRZ-DF002	Common for all models which can select the DI control kit. (Option "Y")

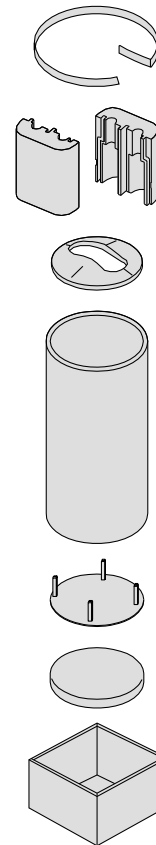



Series HRGC

Specific Product Precautions 1

Be sure to read this before handling. Refer to the back cover for Safety Instructions and "Handling Precautions for SMC Products" (M-E03-3) for Temperature Control Equipment Precautions.

Design

Warning

- This catalog shows the specification of a single unit.**
 - Confirm the specification of the single unit (contents of this catalog) and thoroughly consider the adaptability between the customer's system and this unit.
 - Although the protection circuit as a single unit is installed, prepare a drain pan, water leakage sensor, discharge air facility, and emergency stop equipment, depending on the customer's operating condition. Also, the customer is requested to carry out the safety design for the whole system.
- When attempting to cool areas that are open to the atmosphere (tanks, pipes), plan your piping system accordingly.**
When cooling open-air external tanks, arrange the piping so that there are coil pipes for cooling inside the tanks, and to carry back the entire flow volume of circulating fluid that is released.

Selection

Warning

- Model selection**
For selecting a model of Thermo-cooler, it is required to know the heat generation amount of a customer's equipment. Obtain the heat generation amount, referring to the model selection example for the HRGC series before selecting a model.
- Indication of model number**
Select the cooling method and temperature stability depending on the customer's application.

Handling

Warning

- Thoroughly read the operating manual.**
Read the operating manual completely before operation, and keep a copy on-site, for future reference.

Operating Environment / Storage Environment

Warning

- Do not use in the following environment because it will lead to a breakdown.**
 - Environment like written in "Temperature Control Equipment Precautions".
 - Locations where spatter will adhere to when welding.
 - Locations where it is likely that the leakage of flammable gas may occur.
 - Locations having a large quantity of dust.
If it is necessary to use the unit in an environment where there is a risk of the fin portion of the air-condenser becoming clogged, use the dustproof filter set (sold separately).
 - A place in which water freezes. If such an environment is unavoidable, please contact SMC.
- Install in an environment where the unit will not come into direct contact with rain or snow. (HRGC001 to HRGC005)**
These models are for indoor use only. Do not install outdoors where rain or snow may fall on them.
- Conduct ventilation and cooling to discharge heat.**
(Air-cooled refrigeration)
The heat which is cooled down through air-cooled condenser is discharged.
When using in a room which is shut tightly, ambient temperature will exceed the specification range stipulated in this catalog, which will activate the safety detector and stop the operation.
In order to avoid this situation, discharge the heat outside of a room by ventilation or cooling facilities.
- The Thermo-cooler is not designed for a clean room. It generates particles internally.**

Circulating Fluid

Caution

- Avoid oil or other foreign objects entering the circulating fluid.**
- Use an ethylene glycol aqueous solution that does not contain additives (such as preservatives, etc.).**

Circulating Fluid

Caution

- The concentration of ethylene glycol aqueous solution must be 15% or less.**
Overly high concentration aqueous solution will overload to the pump and activates the safety interlock, which may stop the operation. On the other hand, if the concentration is too low, the aqueous solution freezes at low temperature, which may cause malfunction in the product.
- When using clear water as a circulating fluid, use water that conforms to the appropriate water quality standards.**
Use clear water (including diluted ethylene glycol aqueous solution) that satisfies the quality standard shown below.

Clean Water (as Circulating Fluid) Quality Standard

The Japan Refrigeration and Air Conditioning Industry Association

JRA GL-02-1994 "Cooling water system - Circulation type - Make-up water"

	Item	Unit	Standard value
Standard item	pH (at 25°C)	—	6.8 to 8.0
	Electrical conductivity (25°C)	[μS/cm]	100* to 300*
	Chloride ion (Cl ⁻)	[mg/L]	50 or less
	Sulfuric acid ion (SO ₄ ²⁻)	[mg/L]	50 or less
	Acid consumption amount (at pH4.8)	[mg/L]	50 or less
	Total hardness	[mg/L]	70 or less
	Calcium hardness (CaCO ₃)	[mg/L]	50 or less
Reference item	Ionic state silica (SiO ₂)	[mg/L]	30 or less
	Iron (Fe)	[mg/L]	0.3 or less
	Copper (Cu)	[mg/L]	0.1 or less
	Sulfide ion (S ₂ ⁻)	[mg/L]	Should not be detected.
	Ammonium ion (NH ₄ ⁺)	[mg/L]	0.1 or less
	Residual chlorine (Cl)	[mg/L]	0.3 or less
	Free carbon (CO ₂)	[mg/L]	4.0 or less

* In the case of [MΩ·cm], it will be 0.003 to 0.01.

- Deionized water can be used (as supply water), but resistivity cannot be maintained.**
When supplying water, use deionized water with electrical conductivity of 1 μS/cm or more (electrical resistivity: 1 MΩ·cm or less). However, since components of the wetted part will be released in water, electrolyte concentration cannot be maintained.

(HRGC001/002)

- A magnet pump is used as a circulating pump for the circulating liquid.**
It is particularly impossible to use liquid including metallic powder such as iron powder.

Transportation / Transfer / Movement

Warning

- Transportation by forklift (HRGC001 to HRGC005)**
 - A licensed driver should drive the forklift.
 - The proper place to insert the tines of the forklift differs depending on the model of cooler. Check the operating manual to confirm, and be sure to drive the fork in far enough for it to come out the other side.
 - Be careful not to bump the fork to the cover panel or piping ports.
- Hanging transportation (HRGC005)**
 - Crane manipulation and slinging work should be done by an eligible person.
 - Do not grip the piping or the handles of the panel on the right side.
 - When hanging by the eye bolts, be sure to use a 4-point hanging method. For the hanging angle, use caution regarding the position of the center of gravity and hold it within 60°.

HRGC001, HRGC002

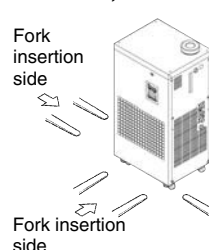

HRGC005 Hanging position

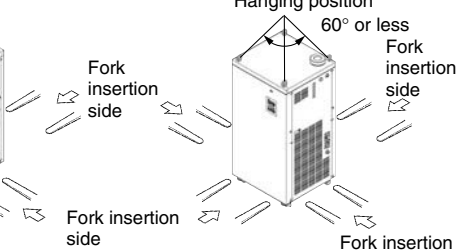

3. Transporting using casters

- This product is heavy and should be moved by at least two people.
- Do not grip the piping port on the right side or the handles of the panel.
- When transporting using a forklift, be sure not to let it hit the casters or adjusters, and drive the fork all the way through until it comes out the other side.



Series HRGC

Specific Product Precautions 2

Be sure to read this before handling. Refer to the back cover for Safety Instructions and "Handling Precautions for SMC Products" (M-E03-3) for Temperature Control Equipment Precautions.

Mounting / Installation

Warning

- Do not place heavy objects on top of this product or step on it.**
The external panel can be deformed and danger can result.
- Do not directly touch the edge of the external panel when removing and installing it.**
It may cause injury. Be sure to wear protective gloves.
- Lower the adjusters and do not move.**
Be sure to lower all four adjusters to the level of the floor.

Caution

- Install on a rigid floor which can withstand this product's weight.**
- Secure with bolts, anchor bolts, etc.**
Fasteners such as bolts or anchor bolts should be tighten with the recommended torque shown below.

Fixing Threads Tightening Torque

Connection thread	Applicable tightening torque N·m	Connection thread	Applicable tightening torque N·m
M3	0.63	M8	12.5
M4	1.5	M10	24.5
M5	3	M12	42
M6	5.2		

(When using optional accessories/dustproof filter set)

- Use the attached surface fastener (with adhesive tape) to affix the dustproof filter to the panel of the Thermo-cooler.**
- Mounting the filter will create a certain amount of resistance to ventilation that will reduce the volume of airflow.**
For this reason, be sure to keep the ambient temperature at 40°C or less.
- Depending on the installation height of the Thermo-cooler and/or the cooled substrates, circulating fluid may overflow from the tank lid or overflow outlet.**
In particular, avoid overflow from the lid of the built-in tank by installing with a height difference of 10 m or less.
Be sure to pipe the overflow outlet to a wastewater collection pit, etc.

Piping

Caution

- Regarding the circulating fluid pipings, consider carefully the suitability for shutoff pressure, temperature and circulating fluid.**
If the operating performance is not sufficient, the pipings may burst during operation.
- For the circulating fluid pipings, use clean pipings which have no dust, piping debris or other foreign objects inside the pipings, and blow with air prior to undertaking any piping works.**
If piping debris or other foreign objects remain inside the circulating fluid circuit, it can result in blockage, insufficient cooling or damage to the pump impeller.
- Select the piping port size which can exceed the rated flow.**
For the rated flow, refer to the pump capacity table.
- When tightening at the circulating fluid inlets and outlets, tank drain port or overflow outlet of this product, use a pipe wrench to clamp the connection ports.**
- For the circulating fluid piping connection, install a drain pan and wastewater collection pit just in case the circulating fluid may leak.**
- While cleaning the inside of the tank, attach a valve to the tank drain outlet to drain the circulating fluid (clear water).**
- This product series consists of circulating fluid temperature controllers with built-in tanks.**
Do not install equipment on your system side such as pumps that forcibly return the circulating fluid to the unit. Also, if you attach an external tank that is open to the air, it may become impossible to circulate the circulating fluid. Proceed with caution.

Piping

Caution

(Water-cooled refrigeration HRGC□□□-W□)

- When tightening at the facility water inlets and outlets of this product, use a pipe wrench to clamp the connection ports.**
- Install by-pass piping.**
This product has a built-in water control valve, so when the refrigeration circuit is stopped, facility water does not flow out in order to save energy. For this reason, by-pass piping is necessary for conducting maintenance of your facility water equipment, so be sure to install it.

Electrical Wiring

Warning

- Never change the set value of the safety instrument.**
If the set value is changed, it will likely cause a breakdown or cause the product to catch on fire.
- Before wiring, be sure to cut the power supply.**
Never perform any job while the product is energized.
- Secure the cable so that its force, etc. is not applied to the terminal connector parts.**
When the connection or attachment is incomplete, it will likely lead to an electrical shock, a fire, etc.
- Grounding should never be connected to a water line, gas line or lightning rod.**
- Multiple wiring is dangerous because it will lead to heat generation or cause a fire.**

Caution

- Power supply, signal cable and connecting terminal should be prepared by customer.**
(When using the HRGC□□□-□□-C with optional communications function)
- Communication cables and adapters should be prepared by customer.**
Prepare parts that conform to the connector specifications of your host computer.
- Pay attention to the polarity when connecting communication cables.**

Facility Water Supply

Warning

(Water-cooled refrigeration HRGC□□□-W□)

- Before startup, be sure to open the valve of your facility water equipment.**
Prepare before startup, so that facility water can flow when the fitted water control valve (facility water control valve) opens during operation.
- Supply pressure should be 0.5 MPa or less.**
When the supply pressure is high, it will cause water leakage.
- Be sure to prepare your utilities so that the pressure of the Thermo-cooler facility water outlet is at 0 MPa (atmospheric pressure) or more.**
If the facility water outlet pressure becomes negative, the internal facility water piping may collapse, and proper flow control of facility water will be impossible.

Operation

Warning

- Confirmation before operation**
 - The fluid level of a tank should be within the specified range of "HIGH" and "LOW".
When exceeding the specified level, the circulating fluid will overflow.
 - Remove the air.
Conduct a trial operation, looking at the fluid level.
Since the fluid level will go down when the air is removed from a customer's piping system, supply water once again when the fluid level is reduced. When there is no reduction in the fluid level, the job of removing the air is completed.



Series HRGC

Specific Product Precautions 3

Be sure to read this before handling. Refer to the back cover for Safety Instructions and "Handling Precautions for SMC Products" (M-E03-3) for Temperature Control Equipment Precautions.

Operation

⚠ Warning

3. Handling of by-pass valve
At the time this product is shipped from our factory, the by-pass valve is fully open.
Operation with it fully closed will cause the circulating fluid outlet pressure to increase high and it may safely stop in order to prevent the pump's operation from overloading.
When operating for the first time after installation, be sure to operate it with the by-pass valve fully open.
2. Confirmation during operation
 1. Adjust the by-pass valve.
Monitor the external piping, pressure gauge, or flow meter mounted on the equipment from the customer's side, in order to adjust the open angle of the by-pass valve, so that the required pressure or flow can be obtained.
 2. Confirm the circulating fluid temperature.
The operating temperature range of the circulating fluid is between 5 and 35°C.
When the amount of heat generated from a customer's equipment is greater than the product's capability, the circulating fluid temperature may exceed this range. Use caution regarding this matter.
3. Emergency stop method
 - When an abnormality is confirmed, stop the equipment immediately. After pushing the (OFF) switch, be sure to turn off the power supply breaker.

⚠ Caution

1. The temperature set value can be written to EEPROM, but only up to approximately one million times.
Especially when using communication function, save data with STOR before stoppage, and do not carry out frequent saving (STOR) of temporary setting values.

Operation Restart Time

⚠ Caution

1. Wait five minutes or more before restarting operation after it has been stopped. If the operation is restarted within five minutes, the protection circuit may activate and the operation may not start properly.

Protection Circuit

⚠ Caution

1. If operating in the below conditions, the protection circuit will activate and an operation may not be performed or will stop.
 - Power supply voltage is not within the rated voltage range of $\pm 10\%$.
 - In case the water level inside the tank is reduced abnormally.
 - Facility water is not supplied. (HRGC□□□-W)
 - Transfer pressure of the circulating fluid is too high.
 - Circulating fluid temperature is too high.
 - Compared to the cooling capacity, the heat generation amount of a customer's equipment is too high.
 - Ambient temperature is too high (40°C or higher)
 - Refrigerant pressure is too high.
 - Ventilation hole is clogged with dust or dirt. (Especially HRGC□□□-A)

Maintenance

⚠ Warning

1. Do not operate the switch with wet hands or touch electrical parts. This will lead to an electrical shock.
2. In the event of cleaning, do not splash water directly on this product for cleaning.
This will lead to an electrical shock or a fire.
3. When the panel was removed for the purpose of inspection or cleaning, mount the panel after works were done.
If the panel is still open, or running the equipment with the panel removed, it may cause an injury or electric shocks.
4. In the event of cleaning the air-cooled condenser, do not touch the fin directly.
This may lead to injuries.

Maintenance

⚠ Caution

<Periodical inspection every one month>
(Air-cooled refrigeration HRGC□□□-A□)

1. Cleaning the ventilation hole

If the fin portion of the air-condenser becomes clogged with dust or debris, a decline in cooling performance can result.
In order to avoid deforming or damaging the fin, clean it with a long-haired brush or air gun.

(When using optional accessories/dustproof filter set)

1. Clean the dustproof filter.

To prevent dirt or clogging of the dustproof filter from leading to a decline in heat-releasing performance of the air-condenser, clean or wash it regularly.

2. Remove the filter from the Thermo-cooler before cleaning it.

Do not directly splash water on the filter to clean it while it is still attached to the Thermo-cooler.
This can lead to electric shock or fires in the main unit of the thermo-cooler.

<Periodical inspection every three months>

1. Inspect the circulating fluid.

1. When using clear water

• Replacement of clear water

Failure to replace the clear water can lead to the development of bacteria or algae. Replace it regularly depending on your usage conditions.

• Tank cleaning

Consider whether dirt, slime or foreign objects may be present in the circulating fluid inside the tank, and carry out regular cleanings of the tank.

2. When using ethylene glycol aqueous solution

Use a concentration measurement device to confirm that the concentration does not exceed 15%.

Dilute or add as needed to adjust the concentration.

2. Check the water quality of facility water.

Regarding the water quality standards for facility water, refer to "Temperature Control Equipment Precautions".

<Periodical inspection every six months>

(HRGC005-□□) ^{Note 1)}

1. Inspect the circulating fluid.

1. Remove the panel and inspect if there is abnormal leakage from the pump's mechanical seal.

2. Leakage amount of a mechanical seal

Leakage of the mechanical seal cannot be completely avoided due to its construction (rotating machine).

This amount of leakage is stipulated as 3 (cc/h) or less (reference value) according to the JIS standard.

Also, as a guide for periodically replacement, the operation hours is 6000 to 8000 hours. (normally 1 year) ^{Note 2)}

Note 1) In the case of the HRGC001/002, because the pump included in the unit is a magnet pump with no rotating shaft seal, it is not necessary to inspect the mechanical seal (rotating shaft seal).

Note 2) In placing an order of mechanical seal set (service parts), inform us of the complete model number and the production lot number of the product in use.

<Periodical inspection during the winter season>

1. Keep the power supply running (POWER light on, RUN light off), and fully open the valves in the circulating fluid piping.

If the circulating fluid temperature falls below 3°C, the pump will start operating automatically. The heat generated by the pump operation will warm up the circulating fluid. When the temperature rises above 5°C, the pump will stop automatically.

As a result, the circulating fluid maintains a temperature of between 3°C and 5°C, preventing freezing.

2. Make water-removal arrangements beforehand.



In extremely cold weather conditions, the heat generated by the pump as described above may not be enough to prevent freezing.
If you expect these kind of conditions, remove the circulating fluid (especially clear water or deionized water) beforehand.

3. Consult a professional.

For additional methods to prevent freezing (such as commercially available tape heaters, etc.), consult a professional for advice.

Safety Instructions

These safety instructions are intended to prevent hazardous situations and/or equipment damage. These instructions indicate the level of potential hazard with the labels of “**Caution**,” “**Warning**” or “**Danger**.” They are all important notes for safety and must be followed in addition to International Standards (ISO/IEC)*1, and other safety regulations.

-  **Caution:** **Caution** indicates a hazard with a low level of risk which, if not avoided, could result in minor or moderate injury.
-  **Warning:** **Warning** indicates a hazard with a medium level of risk which, if not avoided, could result in death or serious injury.
-  **Danger:** **Danger** indicates a hazard with a high level of risk which, if not avoided, will result in death or serious injury.

- *1) ISO 4414: Pneumatic fluid power – General rules relating to systems.
- ISO 4413: Hydraulic fluid power – General rules relating to systems.
- IEC 60204-1: Safety of machinery – Electrical equipment of machines. (Part 1: General requirements)
- ISO 10218-1: Manipulating industrial robots - Safety. etc.

Warning

- 1. The compatibility of the product is the responsibility of the person who designs the equipment or decides its specifications.**
Since the product specified here is used under various operating conditions, its compatibility with specific equipment must be decided by the person who designs the equipment or decides its specifications based on necessary analysis and test results. The expected performance and safety assurance of the equipment will be the responsibility of the person who has determined its compatibility with the product. This person should also continuously review all specifications of the product referring to its latest catalog information, with a view to giving due consideration to any possibility of equipment failure when configuring the equipment.
- 2. Only personnel with appropriate training should operate machinery and equipment.**
The product specified here may become unsafe if handled incorrectly. The assembly, operation and maintenance of machines or equipment including our products must be performed by an operator who is appropriately trained and experienced.
- 3. Do not service or attempt to remove product and machinery/equipment until safety is confirmed.**
 1. The inspection and maintenance of machinery/equipment should only be performed after measures to prevent falling or runaway of the driven objects have been confirmed.
 2. When the product is to be removed, confirm that the safety measures as mentioned above are implemented and the power from any appropriate source is cut, and read and understand the specific product precautions of all relevant products carefully.
 3. Before machinery/equipment is restarted, take measures to prevent unexpected operation and malfunction.
- 4. Contact SMC beforehand and take special consideration of safety measures if the product is to be used in any of the following conditions.**
 1. Conditions and environments outside of the given specifications, or use outdoors or in a place exposed to direct sunlight.
 2. Installation on equipment in conjunction with atomic energy, railways, air navigation, space, shipping, vehicles, military, medical treatment, combustion and recreation, or equipment in contact with food and beverages, emergency stop circuits, clutch and brake circuits in press applications, safety equipment or other applications unsuitable for the standard specifications described in the product catalog.
 3. An application which could have negative effects on people, property, or animals requiring special safety analysis.
 4. Use in an interlock circuit, which requires the provision of double interlock for possible failure by using a mechanical protective function, and periodical checks to confirm proper operation.

Caution

- 1. The product is provided for use in manufacturing industries.**
The product herein described is basically provided for peaceful use in manufacturing industries.
If considering using the product in other industries, consult SMC beforehand and exchange specifications or a contract if necessary.
If anything is unclear, contact your nearest sales branch.

Limited warranty and Disclaimer/ Compliance Requirements

The product used is subject to the following “Limited warranty and Disclaimer” and “Compliance Requirements”.

Read and accept them before using the product.

Limited warranty and Disclaimer

1. The warranty period of the product is 1 year in service or 1.5 years after the product is delivered.*2)
Also, the product may have specified durability, running distance or replacement parts. Please consult your nearest sales branch.
2. For any failure or damage reported within the warranty period which is clearly our responsibility, a replacement product or necessary parts will be provided.
This limited warranty applies only to our product independently, and not to any other damage incurred due to the failure of the product.
3. Prior to using SMC products, please read and understand the warranty terms and disclaimers noted in the specified catalog for the particular products.

*2) **Vacuum pads are excluded from this 1 year warranty.**

A vacuum pad is a consumable part, so it is warranted for a year after it is delivered. Also, even within the warranty period, the wear of a product due to the use of the vacuum pad or failure due to the deterioration of rubber material are not covered by the limited warranty.

Compliance Requirements

1. The use of SMC products with production equipment for the manufacture of weapons of mass destruction (WMD) or any other weapon is strictly prohibited.
2. The exports of SMC products or technology from one country to another are governed by the relevant security laws and regulations of the countries involved in the transaction. Prior to the shipment of a SMC product to another country, assure that all local rules governing that export are known and followed.

Record of changes

Edition B	* Addition of options.	
	• With communications function (RS-232C)	• With water leakage sensor
	• With heater	• With automatic water supply function
	• With external switch input	• Stainless steel wetted part for circulating fluid
	• High-lift pump	• With DI control kit
	* Addition of “By-pass Piping Set”, “DI (Deionized Water) Filter”, and “Insulating Material for DI (Deionized Water) Filter” to optional accessories. NX	

Safety Instructions

Be sure to read “Handling Precautions for SMC Products” (M-E03-3) before using.

SMC Corporation

Akihabara UDX 15F,
4-14-1, Sotokanda, Chiyoda-ku, Tokyo 101-0021, JAPAN
Phone: 03-5207-8249 Fax: 03-5298-5362
URL <http://www.smcworld.com>
© 2009 SMC Corporation All Rights Reserved

Specifications are subject to change without prior notice and any obligation on the part of the manufacturer.

D-DN

1st printing LY printing NX 12200SZ Printed in Japan.

This catalog is printed on recycled paper with concern for the global environment.