

Decentralized Serial Wiring (GW System, 4 Branches) Series EX500

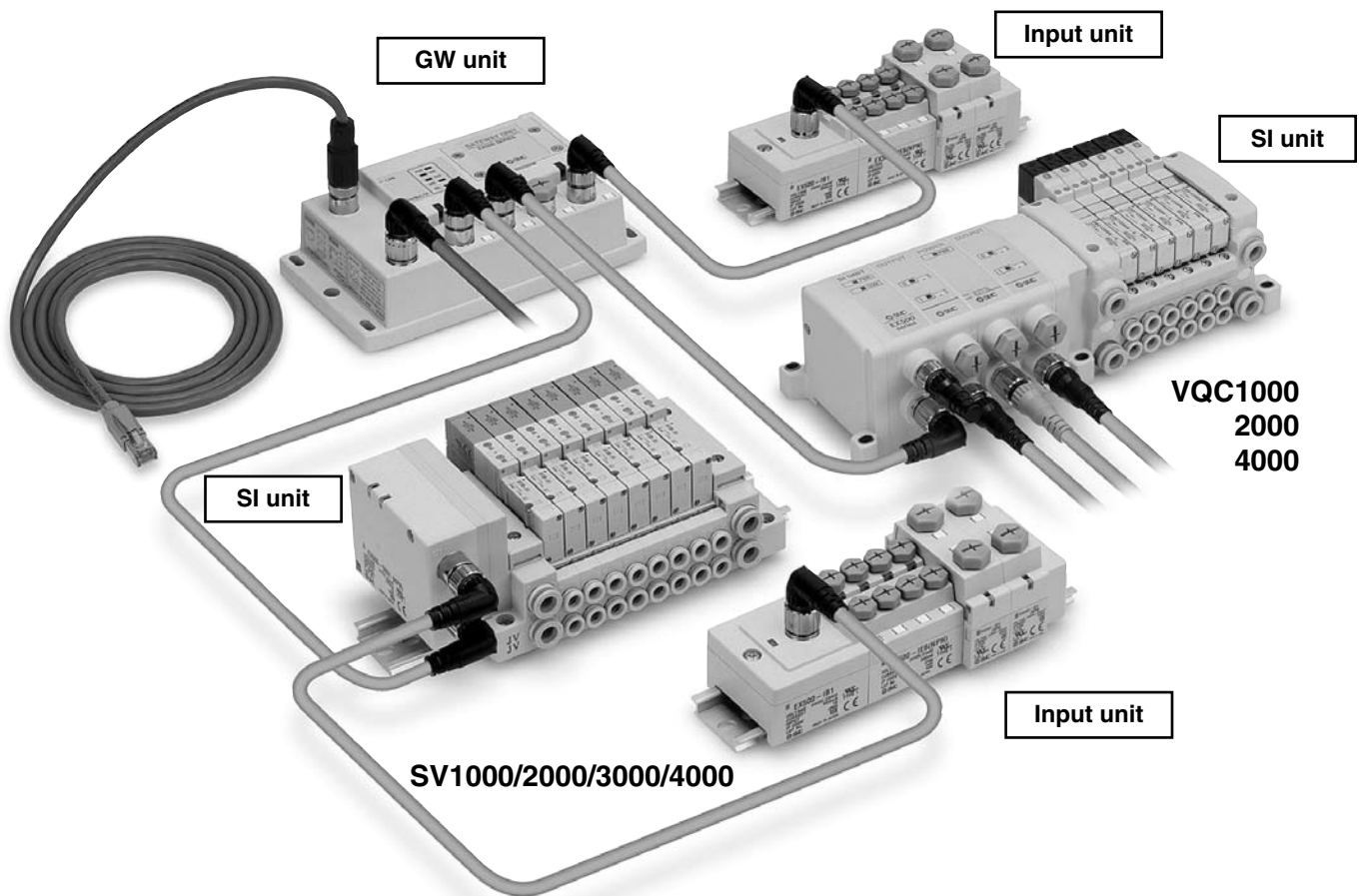

- ★ Valve manifold and input unit manifold can be connected around the GW unit.
- ★ Compatible with various protocols by replacing the GW unit.
- ★ Compatible with 64-digital-outputs (16 points x 4 branches) and 64-digital-inputs (16 points x 4 branches).
- ★ GW unit, Input unit manifold: IP65
- ★ Valve manifold including SI unit: IP67



How to Order GW Unit

GW Unit

EX500 – G **DN1**

• Communication protocol

DN1	DeviceNet
PR1A	PROFIBUS DP
MJ1	CC-Link
EN1	EtherNet/IP



GW Unit Specifications

Model		EX500-GDN1	EX500-GPR1A	EX500-GMJ1	EX500-GEN1	
Communication specification	Applicable system	Protocol	DeviceNet	PROFIBUS DP	CC-Link	EtherNet/IP
		Version ^{Note 1)}	Release 2.0	DP-V0	Ver. 1.10	Release 1.0
	Communication speed	125k/250k/500kbps	9.6 k/19.2 k/45.45 k/ 93.75 k/187.5 k/500 k/ 1.5 M/3 M/6 M/12 Mbps	156 k/625 k/ 2.5 M/5 M/10 Mbps	10 M/100 Mbps	
	Specified file ^{Note 2)}	EDS file	GSD file	—	EDS file	
	Occupied area (Number of inputs/outputs)	64/64	64/64	96/96 (3 stations, remote device station)	128/128	
Terminal resistor	Not applicable	Built in the unit (Switch setting)	Not applicable			
Power supply	For unit	11 to 25 VDC (Supplied by DeviceNet circuit, 50 mA or less)	24 VDC±20%			
	For sensors	24 VDC±20%				
	For valve	24 VDC±10%/–5%				
Internal current consumption (Unit)		200 mA or less (GW unit)				
Input specification	Number of inputs	64 points (16 points x 4 branches)				
	Connection input device	The EX500 series input unit manifold (connection from communication port A to D)				
	Supply voltage	24 VDC				
	Supply current	Max. 2.8 A (Max. 0.7 A per branch)				
Output specification	Number of outputs	64 points (16 points x 4 branches)				
	Connection output device	The EX500 series SI unit manifold (connection from communication port A to D)				
	Supply voltage	24 VDC				
	Supply current	Max. 3.0 A (Max. 0.75 A per branch)				
Branch cable length		5 m or less between connected devices (total extension 10 m or less)				
Environmental resistance	Enclosure	IP65				
	Operating temperature range	Operating: 5 to 45°C Stored: –25 to 70°C (with no freezing and condensation)				
	Operating humidity range	Operating, Stored: 35 to 85%RH (with no condensation)				
	Withstand voltage	1000 VAC for 1 min. between whole charging part and case				
	Insulation resistance	2 MΩ or more (500 VDC Mega) between whole charging part and case				
	Vibration resistance	10 to 150 Hz with a 0.7 mm amplitude or 50 m/s ² in each X, Y, Z direction for 2 hrs (De-energized)				
	Impact resistance	150 m/s ² in each X, Y, Z direction, 3 times (De-energized)				
Standard		CE marking, UL (CSA)				
Mass		470 g				
Accessory: Waterproof cap (for M12 connector socket)		EX500-AWTS (4 pcs.)	EX500-AWTS (5 pcs.)	EX500-AWTS (4 pcs.)	EX500-AWTS (5 pcs.)	

Note 1) Please note that the version is subject to change.

Note 2) Each file can be downloaded from SMC's website (<http://www.smcworld.com/>).

Note 3) For detailed specifications other than the above, refer to the separate technical operation manual can be downloaded from SMC's website (<http://www.smcworld.com/>).

EX

Series EX500

GW Unit Dimensions / Parts Description

EX500-GDN1 (DeviceNet)

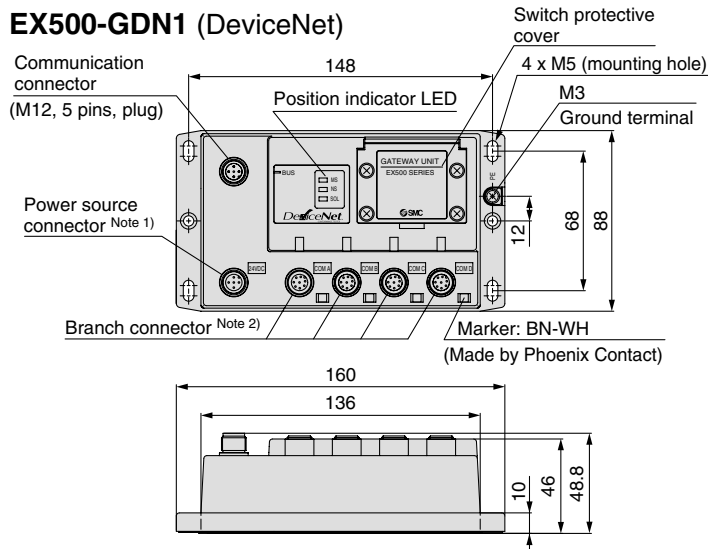

EX500-GPR1A (PROFIBUS DP)

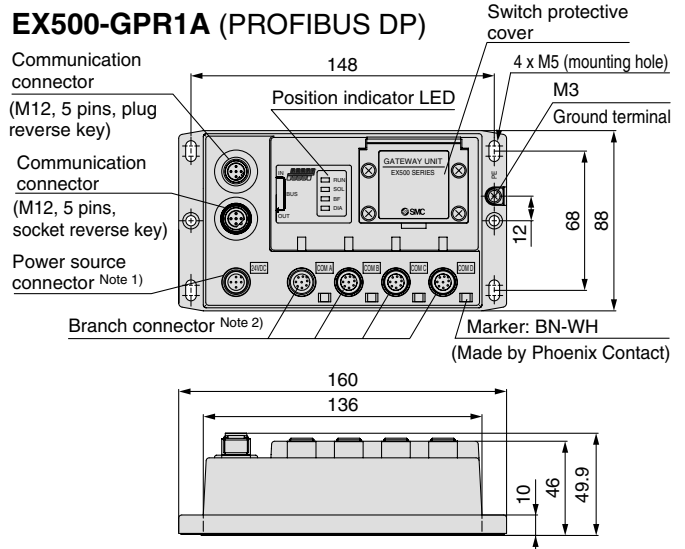

EX500-GMJ1 (CC-Link)

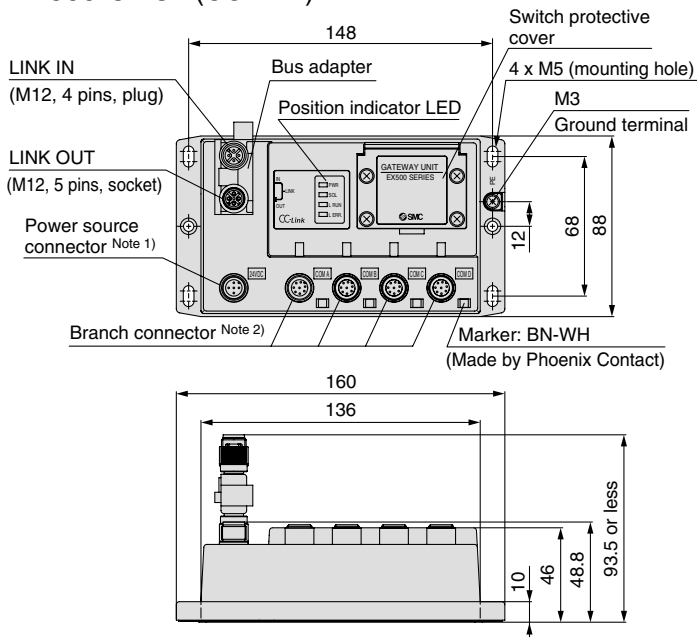

EX500-GEN1 (EtherNet/IP)

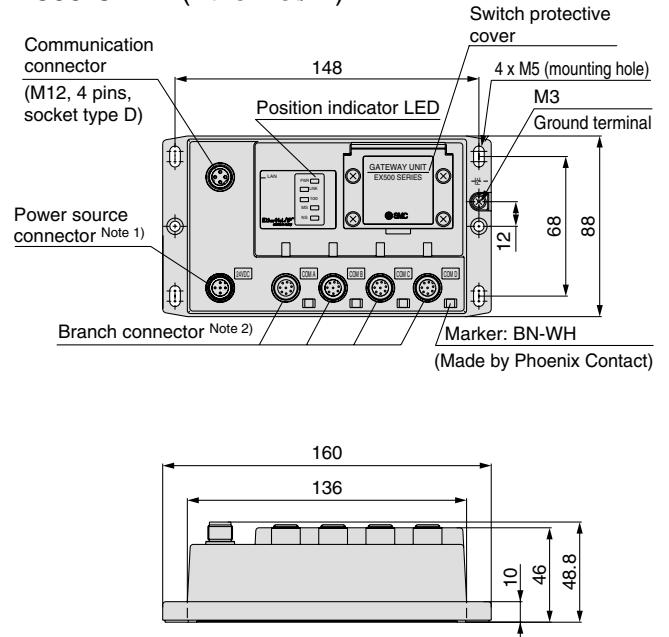

Note 1) Power supply connector specification

(M12, 5 pins, plug)

Note 2) Branch connector specification

(M12, 8 pins, socket)

How to Order Input Manifold

How to Order Input Block

Input Unit Manifold



EEX500-IB1-E 8

Connector type

E	M8 connector
T	M12 connector
M	M8, M12 mixed

Stations

1	1 station
⋮	⋮
8	8 stations

EX500-IE 1

Block type

1	M8 connector, 2 inputs, PNP specification
2	M8 connector, 2 inputs, NPN specification
3	M12 connector, 2 inputs, PNP specification
4	M12 connector, 2 inputs, NPN specification
5	M8 connector, 8 points integrated type, PNP specification
6	M8 connector, 8 points integrated type, NPN specification

For options, refer to pages 1689 to 1694.

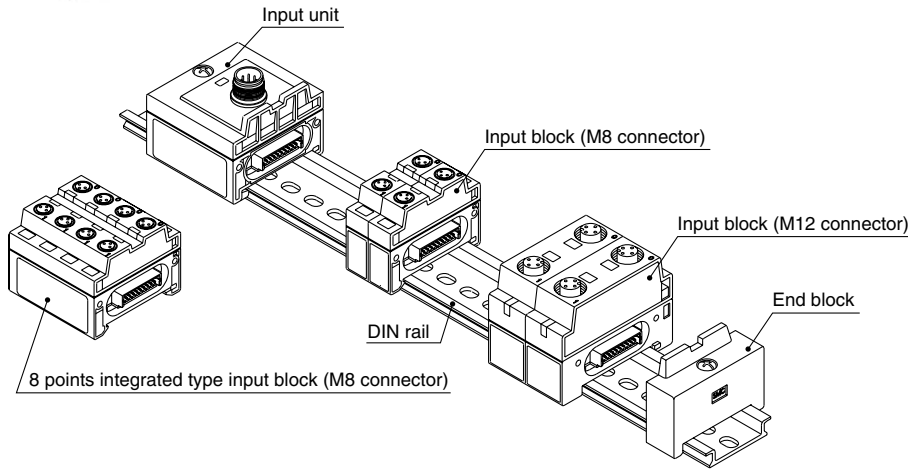

How to Order Input Unit Manifold [Ordering Example]

EX

When ordering an input unit manifold, enter the **Input manifold part no.** + **Input block part no.**

The **Input unit**, **End block** and **DIN rail** are included in the input manifold. Refer to the indications below.

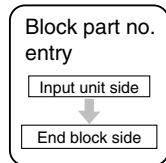

Example 1) M8 input block only

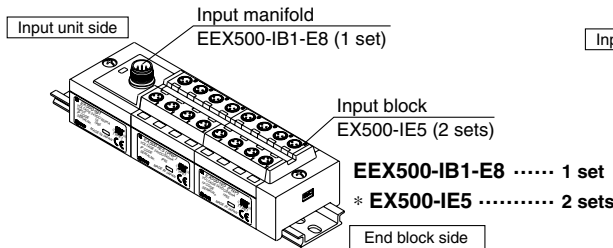

Example 2) M12 input block only

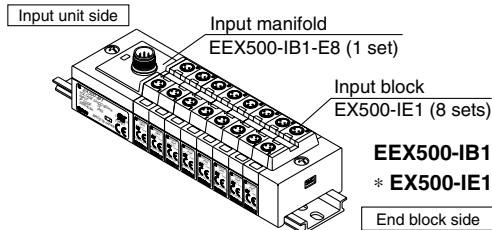
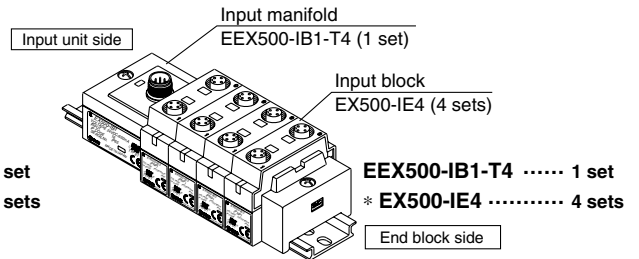

Example 3) M8, M12 mixed

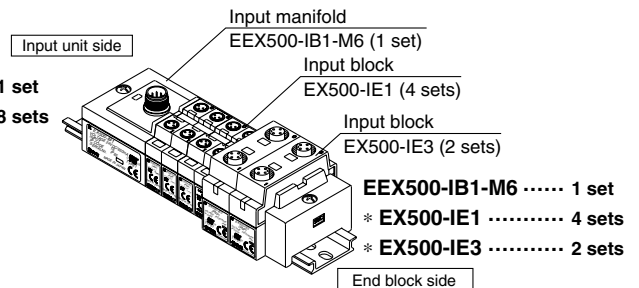
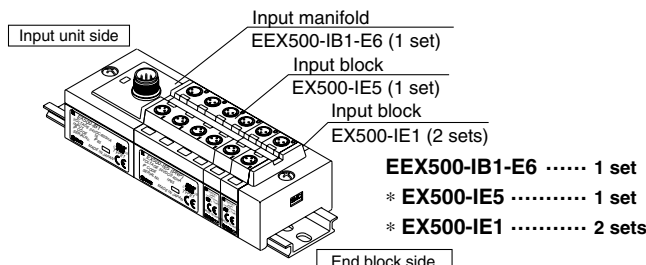

Note • Since the 8 points integrated type input block is equivalent to the length of four stations on an M8 input block, pay attention to the number of stations on an input manifold.
• When an input block layout becomes complicated, indicate in the input unit manifold specification sheet.

Series EX500

Input Unit Specifications

Model		EX500-IB1
Internal current consumption		100 mA or less
Input specification	Number of inputs	16 points
	Connection block	The EX500 series input block (possible to be positioned with others)
	Connection block stations	2-input, input block: Max. 8 stations 8-input, input block: Max. 2 stations
Environmental resistance	Enclosure	IP65
	Operating temperature range	Operating: 5 to 45°C Stored: -25 to 70°C (with no freezing and condensation)
	Operating humidity range	Operating, Stored: 35 to 85%RH (with no condensation)
	Withstand voltage	1000 VAC for 1 min. between whole charging part and case
	Insulation resistance	2 MΩ or more (500 VDC Mega) between whole charging part and case
	Vibration resistance	10 to 150 Hz with a 0.7 mm amplitude or 50 m/s ² in each X, Y, Z direction for 2 hrs (De-energized)
	Impact resistance	150 m/s ² in each X, Y, Z direction, 3 times (De-energized)
Standard		CE marking, UL (CSA)
Mass		100 g (Input unit + End block)

Input Block Specifications

Model		EX500-IE1	EX500-IE2	EX500-IE3	EX500-IE4	EX500-IE5	EX500-IE6	
Input specification	Input type	PNP sensor input	NPN sensor input	PNP sensor input	NPN sensor input	PNP sensor input	NPN sensor input	
	Number of inputs	2 points				8 points		
	Input device supply voltage	24 VDC						
	Input device supply current	Max. 480 mA/Input unit manifold						
	Rated input current	Approx. 5 mA						
	Display	Green LED (Lights when power is turned ON.)						
	Connector on the input device side	M8 connector (3 pins, plug)		M12 connector (4 pins, plug)		M8 connector (3 pins, plug)		
Environmental resistance	Enclosure	IP65						
	Operating temperature range	Operating: 5 to 45°C Stored: -25 to 70°C (with no freezing and condensation)						
	Operating humidity range	Operating, Stored: 35 to 85%RH (with no condensation)						
	Withstand voltage	1000 VAC for 1 min. between whole charging part and case						
	Insulation resistance	2 MΩ or more (500 VDC Mega) between whole charging part and case						
	Vibration resistance	10 to 150 Hz with a 0.7 mm amplitude or 50 m/s ² in each X, Y, Z direction for 2 hrs (De-energized)						
Impact resistance	150 m/s ² in each X, Y, Z direction, 3 times (De-energized)							
Standard		CE marking, UL (CSA)						
Mass		20 g		40 g		55 g		
Accessory: Waterproof cap	(for M8 connector socket)	EX500-AWES (2 pcs.)		—		EX500-AWES (8 pcs.)		
	(for M12 connector socket)	—		EX500-AWTS (2 pcs.)		—		

Note) For detailed specifications other than the above, refer to the separate technical operation manual that can be downloaded from SMC's website (<http://www.smcworld.com/>).

Input Unit Manifold Dimensions / Parts Description

Input block (M8) only

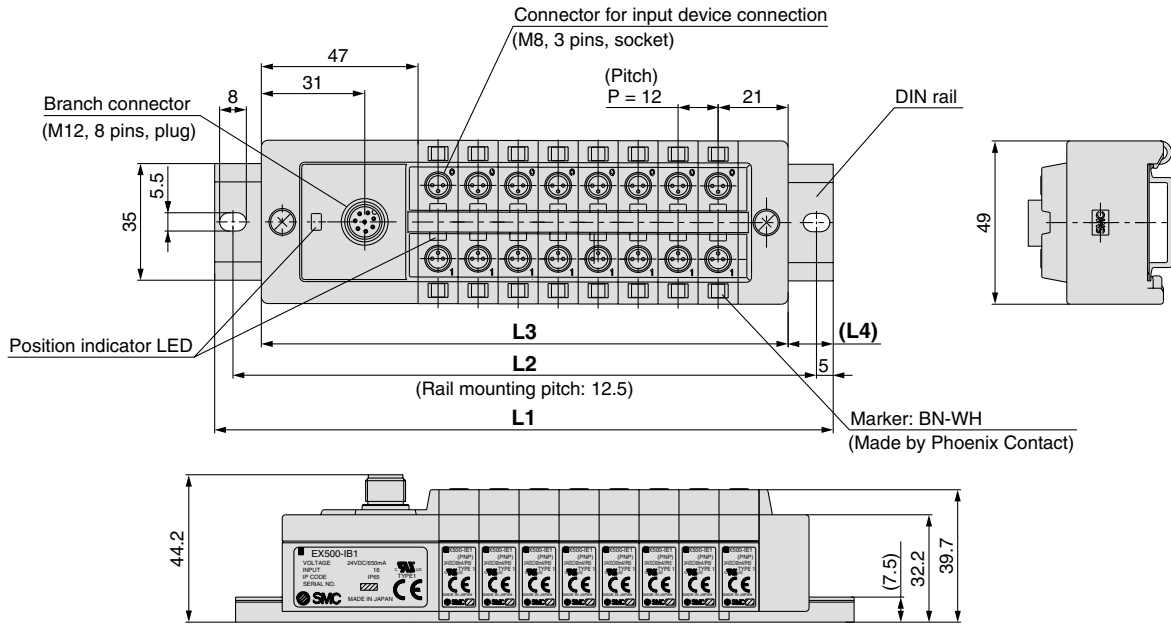

Stations	1	2	3	4	5	6	7	8
Rail length L1	98	110.5	123	135.5	148	160.5	173	185.5
Mounting pitch L2	87.5	100	112.5	125	137.5	150	162.5	175
Manifold length L3	74	86	98	110	122	134	146	158
L4	12	12	12.5	12.5	13	13	13.5	13.5

Input block (M12) only

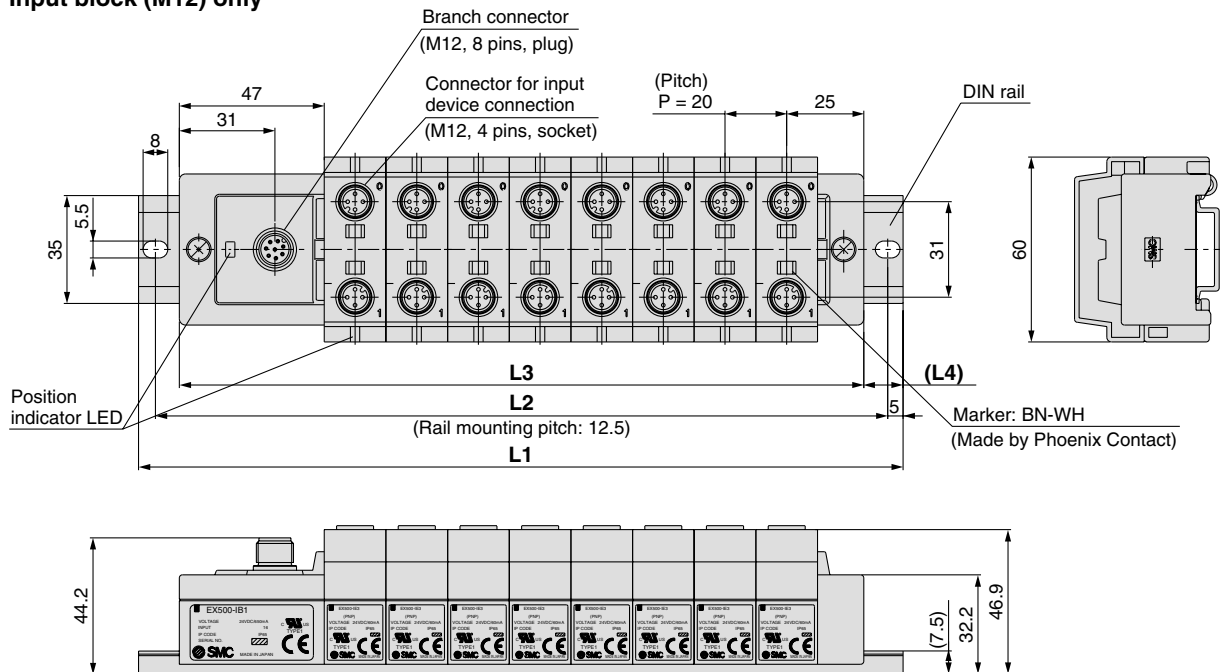

Stations	1	2	3	4	5	6	7	8
Rail length L1	110.5	123	148	173	185.5	210.5	223	248
Mounting pitch L2	100	112.5	137.5	162.5	175	200	212.5	237.5
Manifold length L3	82	102	122	142	162	182	202	222
L4	12	12	12.5	12.5	13	13	13.5	13.5

EX

Series EX500

Input Unit Manifold Exploded View

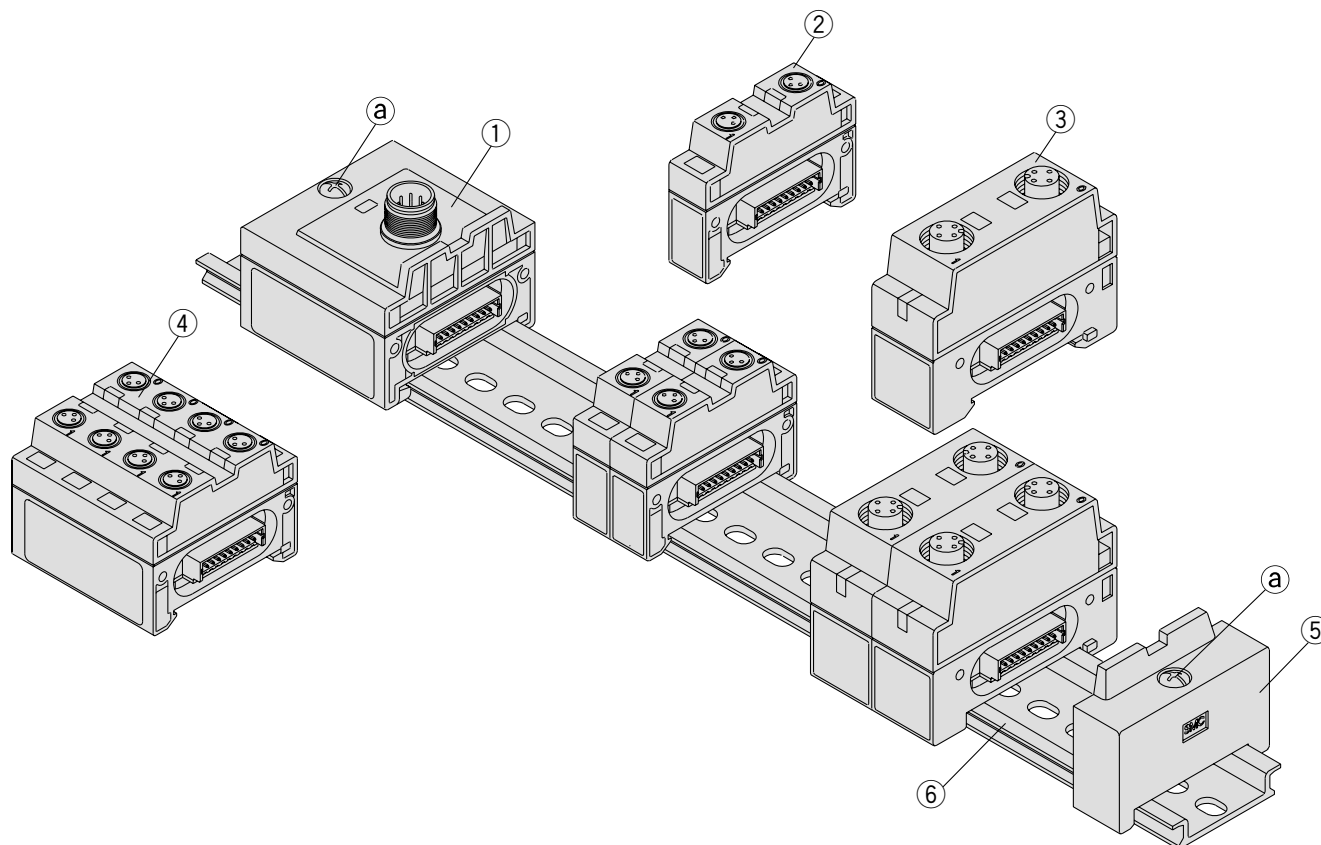

Parts List

No.	Description	Part no.	Note
		For standard	
1	Input unit	EX500-IB1	
2	Input block (M8 connector)	EX500-IE□	PNP specification ... □: 1, NPN specification ... □: 2
3	Input block (M12 connector)	EX500-IE□	PNP specification ... □: 3, NPN specification ... □: 4
4	Input block (M8 connector) 8 points integrated type	EX500-IE□	PNP specification ... □: 5, NPN specification ... □: 6
5	End block	EX500-EB1	
6	DIN rail	VZ1000-11-1-□	□: No. based on L dimension (Refer to the table below.)

How to add input block stations

- 1 Loosen the screws (a) (2 places) that hold the end block.
- 2 Separate the blocks at the locations where stations are to be added.
- 3 Attach the additional blocks to the DIN rail, and connect the blocks so that they fit together securely.
- 4 While holding the blocks together so that there are no gaps between them, secure them to the DIN rail by tightening the screws (a).
Note: Be sure to tighten the round head combination screw with the prescribed tightening torque. (0.6 N·m)

DIN Rail L Dimensions [mm]

Stations	M8 input block (m)										Connector type For E (m = 1 to 8)	No.	L dimension	No.	L dimension																																																																																																																																																																																																																																																																																																																																																																																																																																																																																																																																																																																																																																																																																																																																																																																																																																																																																																																																																																																																																										
	0	1	2	3	4	5	6	7	8	0		7	185.5																																																																																																																																																																																																																																																																																																																																																																																																																																																																																																																																																																																																																																																																																																																																																																																																																																																																																																																																																																																																																												
M12 input block (n)	0	1	2	3	4	5	6	7	8	9	10	11	12	13	14	15	16	17	18	19	20	21	22	23	24	25	26	27	28	29	30	31	32	33	34	35	36	37	38	39	40	41	42	43	44	45	46	47	48	49	50	51	52	53	54	55	56	57	58	59	60	61	62	63	64	65	66	67	68	69	70	71	72	73	74	75	76	77	78	79	80	81	82	83	84	85	86	87	88	89	90	91	92	93	94	95	96	97	98	99	100	101	102	103	104	105	106	107	108	109	110	111	112	113	114	115	116	117	118	119	120	121	122	123	124	125	126	127	128	129	130	131	132	133	134	135	136	137	138	139	140	141	142	143	144	145	146	147	148	149	150	151	152	153	154	155	156	157	158	159	160	161	162	163	164	165	166	167	168	169	170	171	172	173	174	175	176	177	178	179	180	181	182	183	184	185	186	187	188	189	190	191	192	193	194	195	196	197	198	199	200	201	202	203	204	205	206	207	208	209	210	211	212	213	214	215	216	217	218	219	220	221	222	223	224	225	226	227	228	229	230	231	232	233	234	235	236	237	238	239	240	241	242	243	244	245	246	247	248	249	250	251	252	253	254	255	256	257	258	259	260	261	262	263	264	265	266	267	268	269	270	271	272	273	274	275	276	277	278	279	280	281	282	283	284	285	286	287	288	289	290	291	292	293	294	295	296	297	298	299	300	301	302	303	304	305	306	307	308	309	310	311	312	313	314	315	316	317	318	319	320	321	322	323	324	325	326	327	328	329	330	331	332	333	334	335	336	337	338	339	340	341	342	343	344	345	346	347	348	349	350	351	352	353	354	355	356	357	358	359	360	361	362	363	364	365	366	367	368	369	370	371	372	373	374	375	376	377	378	379	380	381	382	383	384	385	386	387	388	389	390	391	392	393	394	395	396	397	398	399	400	401	402	403	404	405	406	407	408	409	410	411	412	413	414	415	416	417	418	419	420	421	422	423	424	425	426	427	428	429	430	431	432	433	434	435	436	437	438	439	440	441	442	443	444	445	446	447	448	449	450	451	452	453	454	455	456	457	458	459	460	461	462	463	464	465	466	467	468	469	470	471	472	473	474	475	476	477	478	479	480	481	482	483	484	485	486	487	488	489	490	491	492	493	494	495	496	497	498	499	500	501	502	503	504	505	506	507	508	509	510	511	512	513	514	515	516	517	518	519	520	521	522	523	524	525	526	527	528	529	530	531	532	533	534	535	536	537	538	539	540	541	542	543	544	545	546	547	548	549	550	551	552	553	554	555	556	557	558	559	560	561	562	563	564	565	566	567	568	569	570	571	572	573	574	575	576	577	578	579	580	581	582	583	584	585	586	587	588	589	590	591	592	593	594	595	596	597	598	599	600	601	602	603	604	605	606	607	608	609	610	611	612	613	614	615	616	617	618	619	620	621	622	623	624	625	626	627	628	629	630	631	632	633	634	635	636	637	638	639	640	641	642	643	644	645	646	647	648	649	650	651	652	653	654	655	656	657	658	659	660	661	662	663	664	665	666	667	668	669	670	671	672	673	674	675	676	677	678	679	680	681	682	683	684	685	686	687	688	689	690	691	692	693	694	695	696	697	698	699	700	701	702	703	704	705	706	707	708	709	710	711	712	713	714	715	716	717	718	719	720	721	722	723	724	725	726	727	728	729	730	731	732	733	734	735	736	737	738	739	740	741	742	743	744	745	746	747	748	749	750	751	752	753	754	755	756	757	758	759	760	761	762	763	764	765	766	767	768	769	770	771	772	773	774	775	776	777	778	779	780	781	782	783	784	785	786	787	788	789	790	791	792	793	794	795	796	797	798	799	800	801	802	803	804	805	806	807	808	809	810	811	812	813	814	815	816	817	818	819	820	821	822	823	824	825	826	827	828	829	830	831	832	833	834	835	836	837	838	839	840	841	842	843	844	845	846	847	848	849	850	851	852	853	854	855	856	857	858	859	860	861	862	863	864	865	866	867	868	869	870	871	872	873	874	875	876	877	878	879	880	881	882	883	884	885	886	887	888	889	890	891	892	893	894	895	896	897	898	899	900	901	902	903	904	905	906	907	908	909	910	911	912	913	914	915	916	917	918	919	920	921	922	923	924	925	926	927	928	929	930	931	932	933	934	935	936	937	938	939	940	941	942	943	944	945	946	947	948	949	950	951	952	953	954	955	956	957	958	959	960	961	962	963	964	965	966	967	968	969	970	971	972	973	974	975	976	977	978	979	980	981	982	983	984	985	986	987	988	989	990	991	992	993	994	995	996	997	998	999	1000

How to Order SI Unit

SI Unit
SV1000/2000/3000/4000

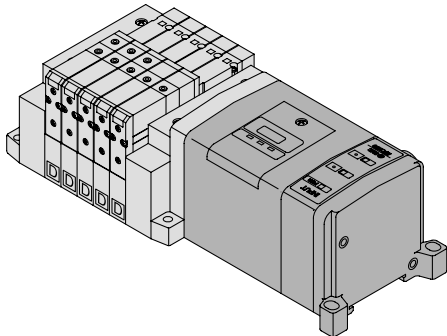

EX500 – S001

● Applicable solenoid valve: SV series

For options, refer to pages 1689 to 1694.

SI Unit Specifications (EX500-S001)

Model		EX500-S001
Internal current consumption		100 mA or less
Output specification	Number of outputs	16 points
	Connection block	Solenoid valve (single, double) Relay output module (1 output, 2 outputs)
	Connection block stations	Double solenoid valve, relay output module (2 outputs): Max. 8 stations Single solenoid valve, relay output module (1 output): Max. 16 stations
	Connection block supply current	Max. 0.65 A
Environmental resistance	Enclosure	IP67
	Operating temperature range	Operating: 5 to 45°C Stored: -25 to 70°C (with no freezing and condensation)
	Operating humidity range	Operating, Stored: 35 to 85%RH (with no condensation)
	Withstand voltage	1000 VAC for 1 min. between whole charging part and case
	Insulation resistance	2 MΩ or more (500 VDC Mega) between whole charging part and case
	Vibration resistance	10 to 150 Hz with a 0.7 mm amplitude or 50 m/s ² in each X, Y, Z direction for 2 hrs (De-energized)
	Impact resistance	150 m/s ² in each X, Y, Z direction, 3 times (De-energized)
Standard		CE marking, UL (CSA)
Mass		115 g
Accessory: Waterproof cap (for M12 connector socket)		EX500-AWTS (1 pc.)

Note) For detailed specifications other than the above, refer to the separate technical operation manual that can be downloaded from SMC's website (<http://www.smcworld.com/>).

EX

SI Unit Dimensions / Parts Description

EX500-S001

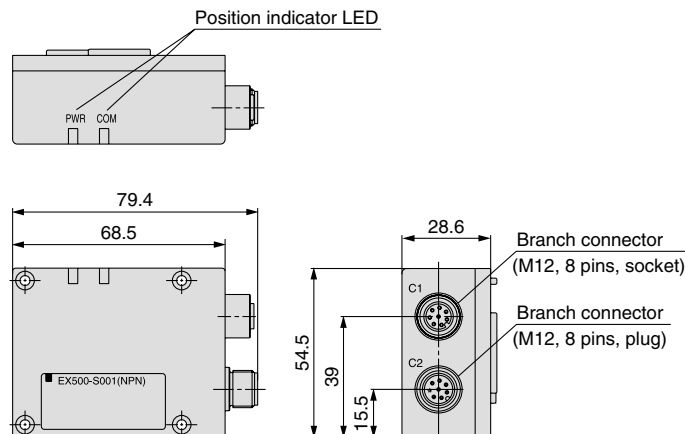

Series EX500

How to Order SI Unit

SI Unit

VQC1000/2000/4000

S0700

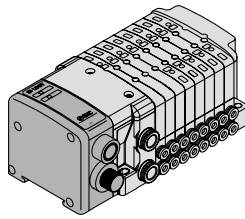
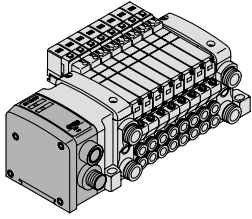

EX500-Q001

Applicable solenoid valve:
VQC/S0700 series

SI unit COM.

0	+COM.
1	-COM.

SI unit type

1	For without EX9 output block
2	For EX9 output block mounting

For options, refer to page 1689 to 1694.

SI Unit Specifications (EX500-Q□0□)

Model	EX500-Q001	EX500-Q101	EX500-Q002	EX500-Q102	
Internal current consumption	100 mA or less				
Output specification	Number of outputs	16 points			
	Output type	NPN output (sink type)	PNP output (source type)	NPN output (sink type)	PNP output (source type)
	Connection block	+COM. Solenoid valve (single, double)	-COM. Solenoid valve (single, double)	+COM. ^{Note)} Output block, power block Solenoid valve (single, double)	-COM. ^{Note 1)} Output block, power block Solenoid valve (single, double)
	Connection block stations	Double solenoid valve: Max. 8 stations Single solenoid valve: Max. 16 stations		Double solenoid valve, output block: Max. 8 stations Single solenoid valve: Max. 16 stations * Power block is not included.	
	Connection block supply current	Max. 0.75 A			
Environmental resistance	Enclosure	IP67			
	Operating temperature range	Operating: 5 to 45°C Stored: -25 to 70°C (with no freezing and condensation)			
	Operating humidity range	Operating, Stored: 35 to 85%RH (with no condensation)			
	Withstand voltage	1000 VAC for 1 min. between whole charging part and case			
	Insulation resistance	2 MΩ or more (500 VDC Mega) between whole charging part and case			
	Vibration resistance	10 to 150 Hz with a 0.7 mm amplitude or 50 m/s ² in each X, Y, Z direction for 2 hrs (De-energized)			
Impact resistance	150 m/s ² in each X, Y, Z direction, 3 times (De-energized)				
Standard	CE marking, UL (CSA)				
Mass	105 g				
Accessory: Waterproof cap (for M12 connector socket)	EX500-AWTS (1 pc.)				

Note 1) For details of output block and power block, refer to page 1692.

Note 2) For detailed specifications other than the above, refer to the separate technical operation manual that can be downloaded from SMC's website (<http://www.smcworld.com/>).

SI Unit Dimensions / Parts Description

EX500-Q□01

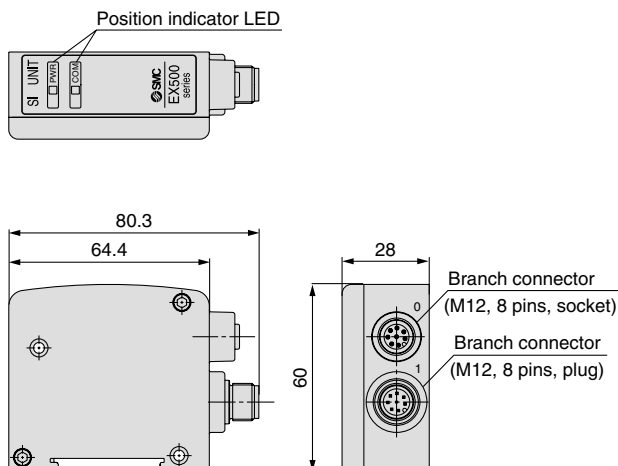

EX500-Q□02

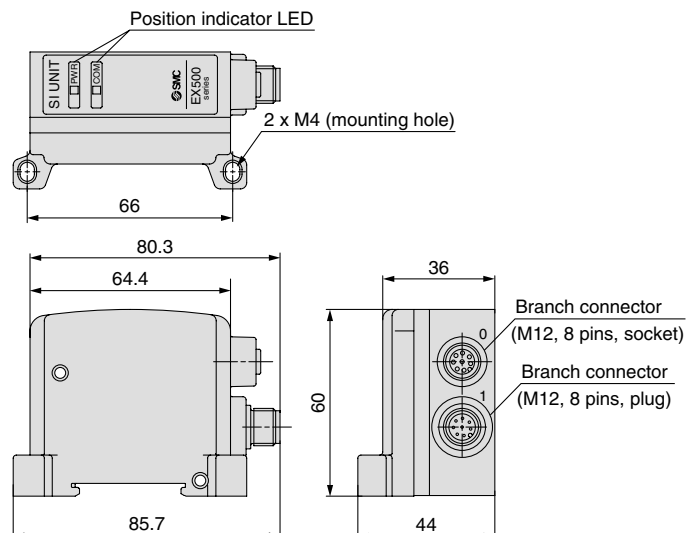

Options

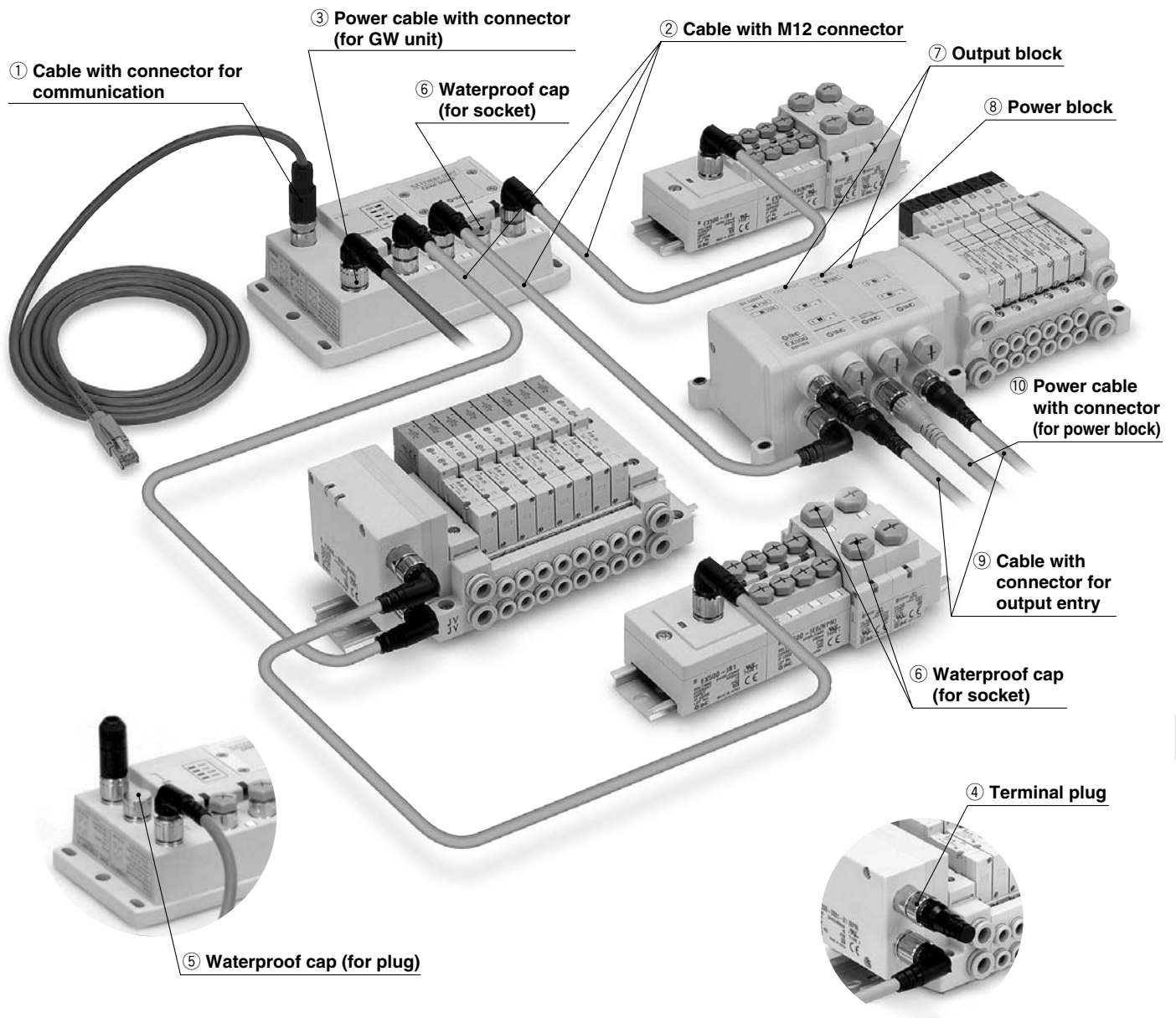

EX

Series EX500

Options

① Cable with communication connector

For DeviceNet type GW unit

EX500-AC 050-DN

Cable length (l)

010	1000 [mm]
050	5000 [mm]

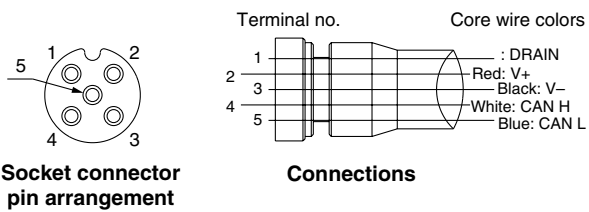
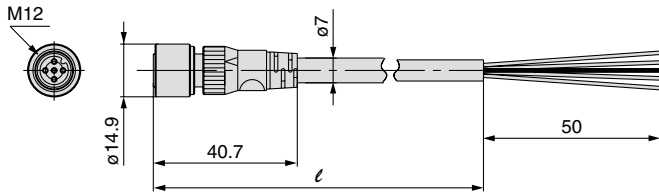

For EtherNet/IP type GW unit

EX9-AC 020 EN-PSRJ

Cable length (l)

020	2000 [mm]
-----	-----------

Connector specification
PSRJ M12 plug (straight)⇔RJ-45 connector

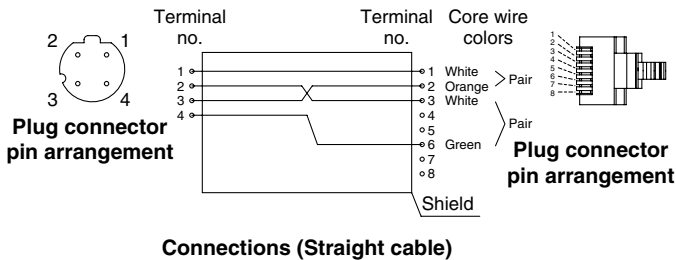
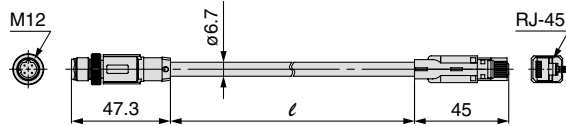

② Cable with M12 connector

EX500-AC 030-SSPS

Cable length (l)

003	300 [mm]
005	500 [mm]
010	1000 [mm]
030	3000 [mm]
050	5000 [mm]

Connector specification

SSPS	Socket side: Straight, Plug side: Straight
SAPA	Socket side: Angle, Plug side: Angle

Straight connector type

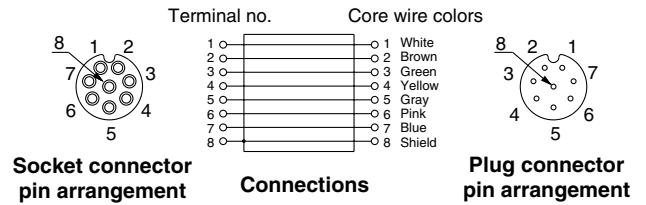
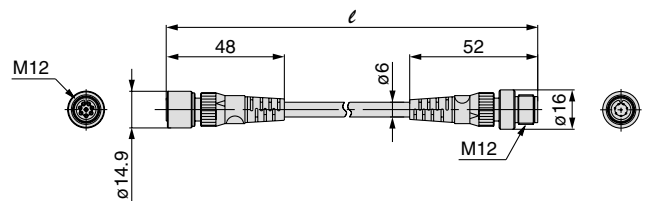

Angle connector type

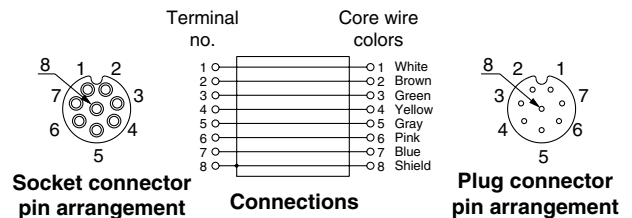
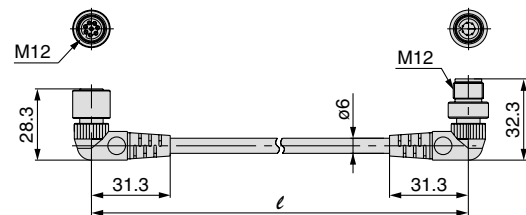

③ Power cable with connector (for GW unit)

EX500-AP050-S

Cable length (ℓ)

010	1000 [mm]
050	5000 [mm]

Connector specification

S	Straight
A	Angle

Straight connector type

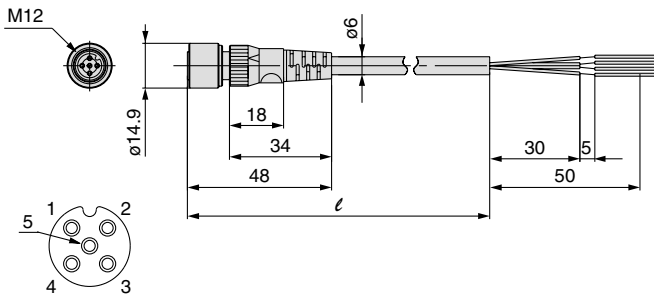

Socket connector pin arrangement

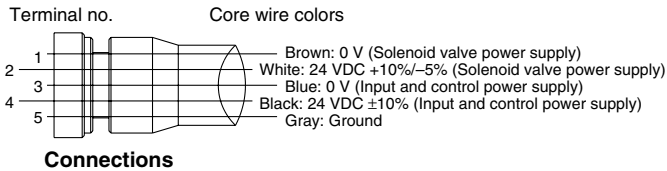

Angle connector type

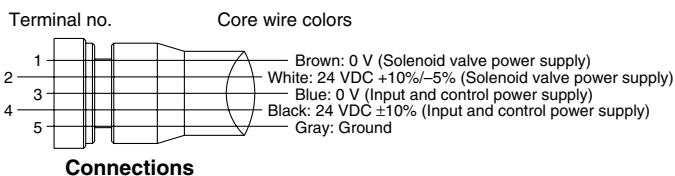
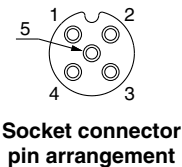
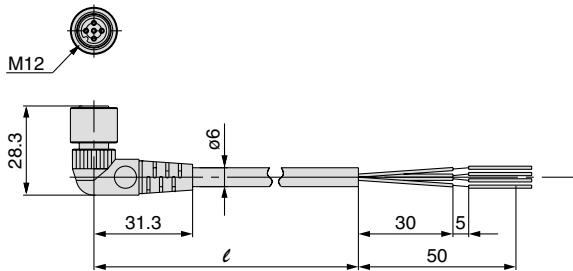

④ Terminal plug

This is used when an input manifold (input unit/input block) is not being used.
(If a terminal plug is not used, the GW unit is COM LED will not light up.)

EX500-AC000-S

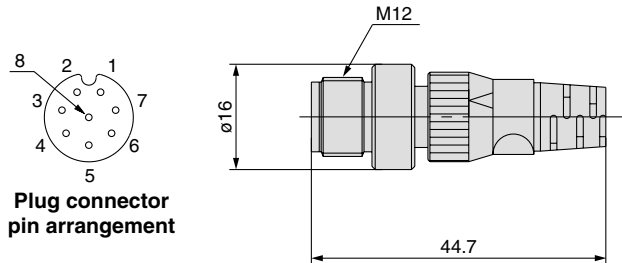

⑤ Waterproof cap: M12 connector (for plug)

Use this on ports that are not being used for an M12 connector (plug). Use of this waterproof cap maintains the integrity of the IP65 enclosure.

Note) Tighten the waterproof cap with the prescribed tightening torque. (For M12: 0.1 N·m)

EX500-AWTP

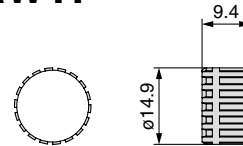

EX

⑥ Waterproof cap: M8, M12 connector (for socket) / Accessory

Use this on ports that are not being used for M8 and M12 connectors (socket). Use of this waterproof cap maintains the integrity of the IP65 enclosure. (Included with each unit.)

Note) Tighten the waterproof cap with the prescribed tightening torque. (For M8: 0.05 N·m, For M12: 0.1 N·m)

EX500-AW

Connector type

ES	M8 connector (for socket), 10 pcs.
TS	M12 connector (for socket), 10 pcs.

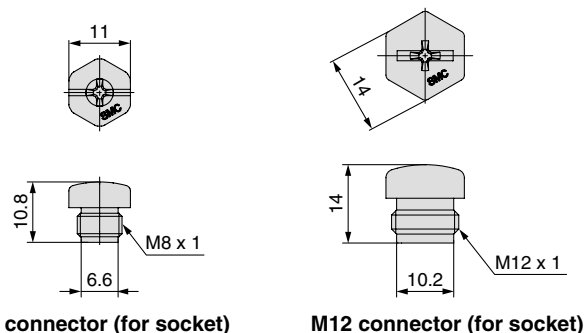

Series EX500

Options

⑦ Output block / ⑧ Power block

Features: • Able to retrofit to the valve manifold, using the unused points.

- 2-output / 1-output block (M12 connector)
- + common / – common are standardized.
- Able to drive by max. 0.5 A per point. (EX9-OEP□)

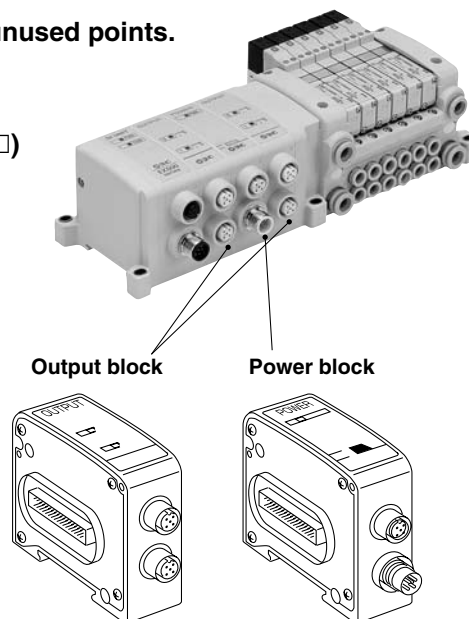

How to Order Output Block

EX9 – OE **T** **1**

• Output specification

1	PNP output (–COM.)
2	NPN output (+COM.)

• Power supply type

T	Internal power supply method (for low-wattage load)
P	Integrated power supply method (for high-wattage load) ^{Note)}

Note) Required to connect with a power block.

How to Order Power Block

EX9 – PE1

Option/Part No.

Description	Part no.	Note
Waterproof cap	EX500-AWTS	Refer to page 1691. When ordering separately: 10 pcs.
Power cable with connector	EX9-AC□-1	Refer to page 1672, Order separately.

SI Unit Part No.

SI unit part no.	Output	Applicable model
EX500-Q002	PNP output (+COM.)	EX9-OET2, EX9-OEP2
EX500-Q102	NPN output (–COM.)	EX9-OET1, EX9-OEP1

Option/Part No.

Description	Part no.	Applicable model		Note
		OET□	OEP□	
Waterproof cap	EX500-AWTS	○	○	Refer to page 1691. Order separately: 10 pcs.
Cable with connector for output entry	EX9-AC□-7	○	○	Refer to page 1677. Order separately.
Power block	EX9-PE1		○	Refer to the right page. Order separately.

Output Block Specifications

Model		EX9-OET1	EX9-OET2	EX9-OEP1	EX9-OEP2
Output connector		M12 connector (5 pins)			
Internal current consumption		40 mA or less			
Output specification	Output type	PNP output (-COM.)	NPN output (+COM.)	PNP output (-COM.)	NPN output (+COM.)
	Number of outputs	2 points			
	Power supply method	Internal power supply method		Integrated power supply method (Power block: supplied from EX9-PE1)	
	Output device supply voltage	24 VDC			
	Output device supply current	Max. 42 mA/point (1.0 W/point) ^{Note)}		Max. 0.5 A/point (12 W/point)	
	Display	Yellow LED (Lights when power is turned ON.)			
	Connector on the output device side	M12 connector (5 pins, plug)			
Environmental resistance	Enclosure	IP67			
	Operating temperature range	-10 to 50°C			
	Operating humidity range	35 to 85%RH (with no condensation)			
	Withstand voltage	1500 VAC for 1 min. between external terminals and FG			
	Insulation resistance	10 MΩ or more (500 VDC) between external terminals and FG			
	Vibration resistance	10 to 150 Hz with a 0.35 mm amplitude or 49 m/s ² in each X, Y, Z direction for 2 hrs (De-energized)			
	Impact resistance	98 m/s ² in each X, Y, Z direction, 3 times (De-energized)			
Standard		CE marking, UL (CSA)			
Mass		120 g			

Note) The rated load current varies due to the output capability of the SI unit when connected to EX500.

Power Block Specifications

Model		EX9-PE1
Connection block		Output block (for high-wattage load)
Connection block stations		Output block: Max. 8 stations
Power supply for output and internal control	Power supply voltage	22.8 to 26.4 VDC
	Internal power consumption	20 mA or less
Supply current		Max. 3.1 A (When using with 3.0 to 3.1 A, the ambient temperature should not exceed 40°C, and do not bundle the cable.)
Environmental resistance	Enclosure	IP67
	Operating temperature range	-10 to 50°C
	Operating humidity range	35 to 85%RH (with no condensation)
	Withstand voltage	1500 VAC for 1 min. between external terminals and FG
	Insulation resistance	10 MΩ or more (500 VDC) between external terminals and FG
	Vibration resistance	10 to 150 Hz with a 0.35 mm amplitude or 49 m/s ² in each X, Y, Z direction for 2 hrs (De-energized)
Impact resistance	98 m/s ² in each X, Y, Z direction, 3 times (De-energized)	
Standard		CE marking, UL (CSA)
Mass		120 g
Accessory: Waterproof cap (for M12 connector socket)		EX500-AWTS (1 pc.)

Note) For detailed specifications other than the above, refer to the separate technical operation manual that can be downloaded from SMC's website (<http://www.smcworld.com/>).

EX

Series EX500

Options

Output Block Dimension

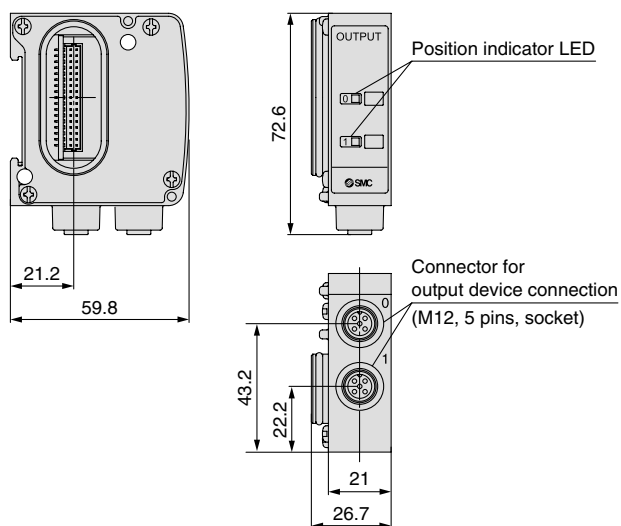

Power Block Dimension

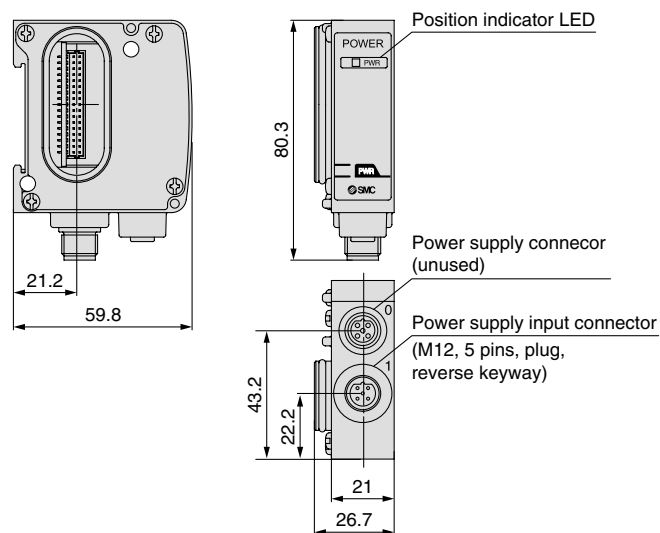

We sell this product individually. Please place an order separately.
 You are requested to connect it to an SI unit and a valve manifold.
 When using the output block only (valve manifold is unused.), place an order for an end plate (⑪ EX9-EA03) separately for connection.
 Refer to the separate technical instruction manual for connection, wiring, installation, optional goods and cable, etc.

⑨ Cable with connector for output entry

EX9-AC 030-7

Cable length (ℓ)

010	1000 [mm]
030	3000 [mm]

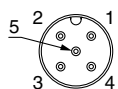

Plug connector pin arrangement

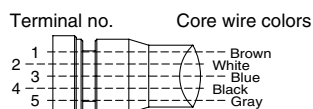
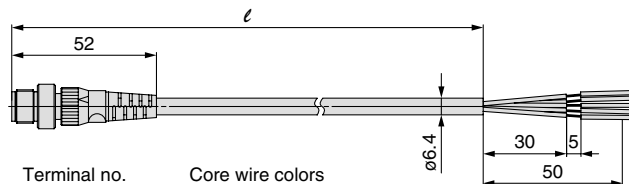

Connections

⑩ Power cable with connector (for power block)

EX9-AC 050-1

Cable length (ℓ)

010	1000 [mm]
030	3000 [mm]
050	5000 [mm]

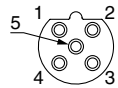

Socket connector pin arrangement Reverse keyway

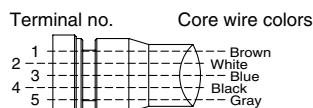
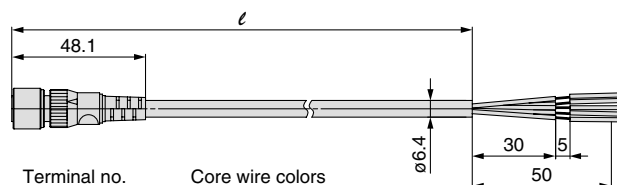

Connections

⑪ End plate

EX9-EA03

