

Safety Speed Control Valve (SSC Valve)

Series ASS

Meter-out control type:

A control valve with cylinder speed control function, fixed throttle, and rapid air supply function

Meter-in control type:

A control valve with cylinder speed control function and rapid air supply function

Model

Style	Model	Port size	Effective area (mm ²)		Weight (g)
			Controlled flow	Free flow	
Meter-out control	ASS100	1/8	2.4	9.5	97
	ASS300	1/4, 3/8	14.5	22.0	220
	ASS500	1/2, 3/4	52.0	55.0	580
	ASS600	3/4, 1	80.0	90.0	950
Meter-in control	ASS110	1/8	2.4	5.4	97
	ASS310	1/4, 3/8	16.5	23.0	220

Specifications

Fluid	Air
Max. operating pressure	0.7 MPa
Ambient and fluid temperature	-5 to 60°C (No freezing)
Set pressure	0.1 to 0.5 MPa



PAT.PEND

JIS Symbol

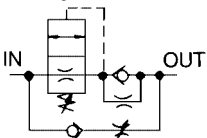

Meter-out control

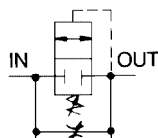

Meter-in control

How to Order

ASS 3 00 — 02 B

Body size	
1	1/8
3	3/8
5	3/4
6	1

Type

00	Meter-out control type
10	Meter-in control type

* Meter-in type is available only for ASS110 and ASS310.

Accessory

Nil	None
B	With bracket

Port size

Port size	Applicable series
01	1/8 ASS100/110
02	1/4 ASS300/310
03	3/8 ASS300/310
04	1/2 ASS500
06	3/4 ASS500/600
10	1 ASS600

Thread type

Nil	Rc
N	NPT
F	G

AS

ASP

ASN

AQ

ASV

AK

ASS

ASR

ASF

⚠ Caution

Be sure to read before handling. Refer to pages 15-18-3 to 15-18-4 for Safety Instructions and Common Precautions on the products mentioned in this catalog, and refer to pages 15-8-6 to 15-8-8 for Precautions on every series.

Series ASS

System Circuit

Prevents accidents caused by sudden cylinder rod extensions

If pressure is applied only to one side of the cylinder, the rod could get out of control, leading to accidents that could involve injury to humans or damage to the product or jigs. The meter-out type SSC valve prevents the sudden extensions by effecting meter-in control when there is no pressure, and resumes the ordinary meter-out control after the cylinder has been pressurized. With the meter-in type, there is no risk of sudden extensions because the cylinder speed is constantly under meter-in control.

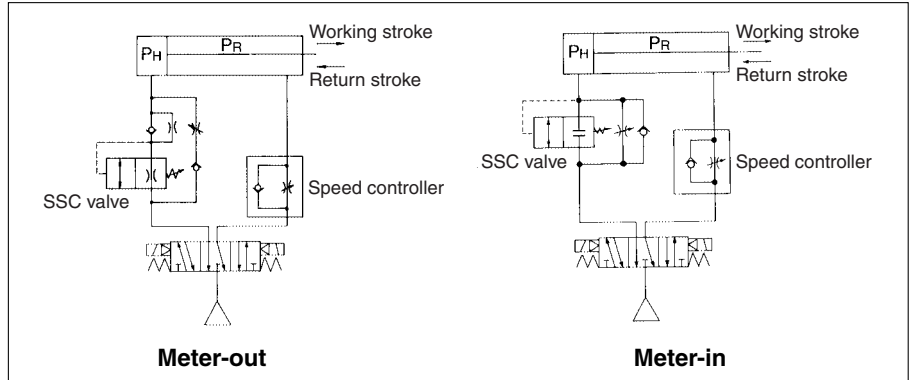

<Meter-out> Graph/Pressure to Time

Opening Stroke during Primary Operation

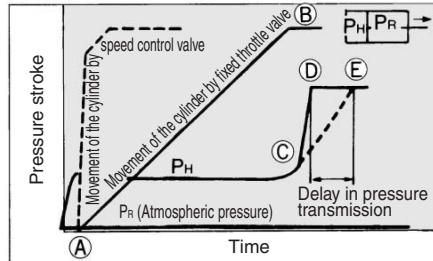

During the operating stroke at initial actuation, the cylinder moves at a slow speed from A to B due to the fixed throttle of the SSC valve. When it reaches B, the head pressure (PH) rises quickly as indicated by the line from C to D. Therefore, there is no time loss associated with the pressure transmission lag indicated by the line from C to E, as in the case of meter-in control that is effected through the use of a speed controller.

During normal operation after the cylinder has been pressurized, the cylinder's speed control is effected by the ordinary meter-out control.

<Meter-in> Graph/Pressure to Time

Opening Stroke during Primary Operation

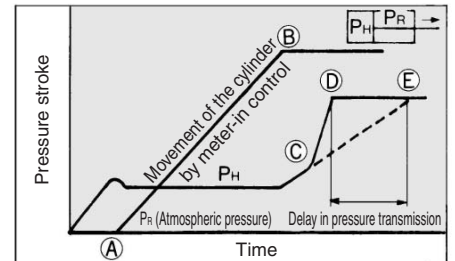

Due to meter-in control, the cylinder moves from A to B regardless of whether it is an initial operation or a normal operation. When it reaches B, the head pressure (PH) rises quickly as indicated by the line from C to D.

Therefore, there is no time loss associated with the pressure transmission lag indicated by the line from C to E, as in the case of meter-in control that is effected through the use of a speed controller.

During normal operation after the cylinder has been pressurized, the cylinder's speed control is effected also by the ordinary meter-in control.

Return Stroke during Normal Operation

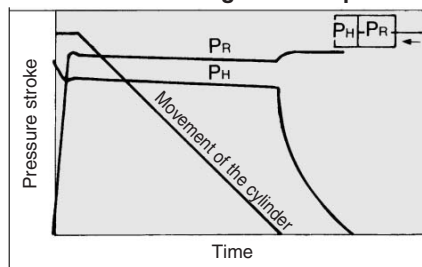

Return Stroke during Normal Operation

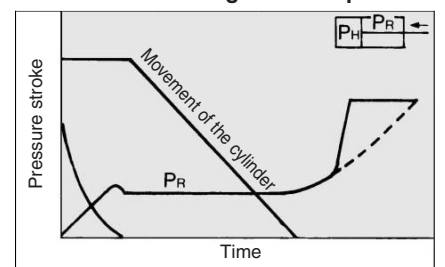

Working Stroke during Normal Operation

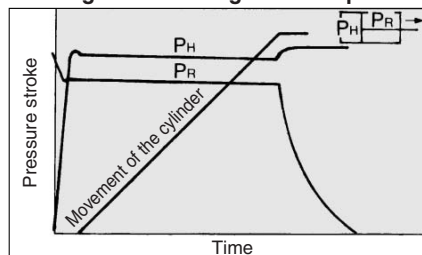

Working Stroke during Normal Operation

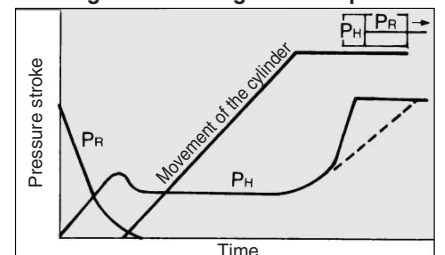

Flow Characteristics

Cylinder Extension Prevention Primary Speed

Meter-out Control

ASS100/ASS110

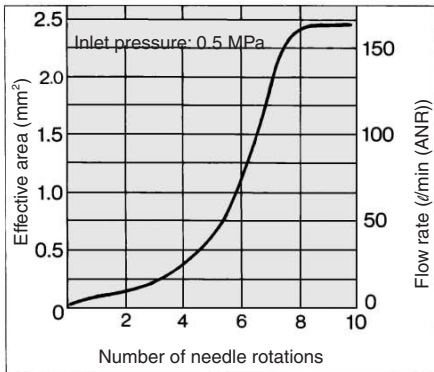

ASS300

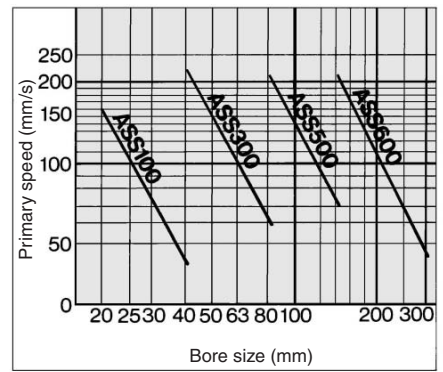
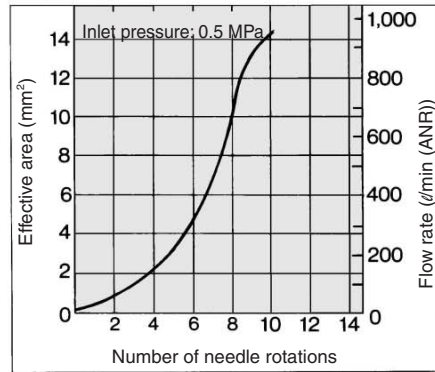

Conditions : Supply pressure at 0.5 MPa, No load
 * Primary speed of meter-in type can be controlled as likely as during normal operation.

ASS310

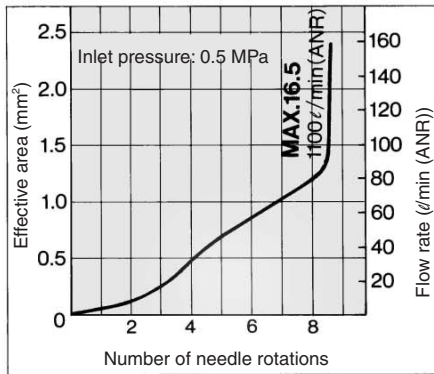

ASS500

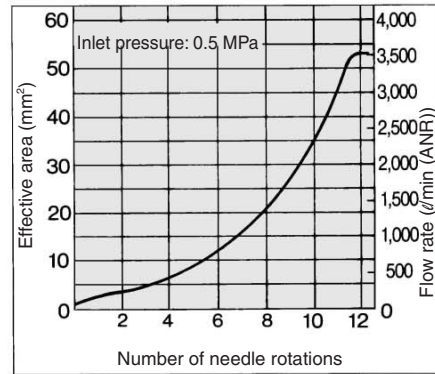

ASS600

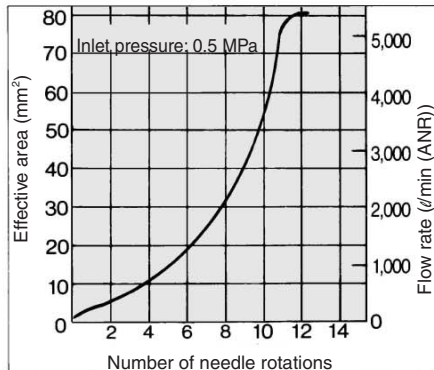

- AS
- ASP
- ASN
- AQ
- ASV
- AK
- ASS**
- ASR
- ASF

Meter-out Control/Construction Principle

**During primary operation
(Piston rod extension prevention)**

Fig. (A)

Set pressure for piston valve
> Pressure in the cylinder

Fig. (A)
When air is supplied to the exhausted cylinder, the air causes the valve to close. Also, because the piston valve is fully closed due to the cylinder's low internal pressure, air is supplied gradually through the piston valve and the fixed throttle of the check valve. Therefore, the cylinder operates slowly under meter-in control.

Fig. (B)

Set pressure for piston valve
< Pressure in the cylinder
(Stroke end)

Fig. (B)
As the piston moves and reaches the end of its stroke, the internal pressure in the cylinder rises. When this pressure becomes higher than the set pressure of the piston valve, the piston valve opens fully. Then, the air from the switching valve feeds rapidly into the cylinder by opening the check valve.

During normal operation

Switching valve → Cylinder

Fig. (C)

Because the pressure in the cylinder is higher than the set pressure, the air from the switching valve causes the piston valve to open fully and feeds rapidly into the cylinder by opening the check valve. Therefore, meter-out control of the cylinder speed is effected by the speed control valve in the exhaust conduit, regardless of the state of the SSC valve.

Cylinder → Switching valve

Fig. (D)

Because the check valve closes due to the internal pressure of the cylinder, the air in the cylinder passes through the valve and discharges through the switching valve. Thus, meter-out control of the cylinder speed is effected by the opening of the valve, which is adjusted by the set needle.

Meter-in Control/Constuction Principle

**During primary operation
(Piston rod extension prevention)**

Fig. (A)

Set pressure for piston valve
> Pressure in the cylinder

Fig. (A)
When air is supplied to the exhausted cylinder, the air causes the check valve to close. Also, because the piston valve is fully closed due to the cylinder's low internal pressure, air is supplied gradually via the throttle of the set needle. Therefore, the cylinder operates slowly under meter-in control.

Fig. (B)

Set pressure for piston valve
< Pressure in the cylinder
(Stroke end)

Fig. (B)
As the piston moves and reaches the end of its stroke, the internal pressure in the cylinder rises. When this pressure becomes higher than the set pressure of the piston valve, the piston valve opens fully. Then, the air from the switching valve feeds rapidly into the cylinder.

During normal operation

Switching valve → Cylinder

Fig. (C)

The air that has been supplied by the switching valve closes the check valve. Also, because the cylinder's internal pressure is lower than the set pressure, the piston valve closes fully, causing the air to be supplied gradually via the throttle of the set needle. Therefore, meter-out control of the cylinder speed is effected by the SSC valve, regardless of the state of the speed control valve in the exhaust conduit of the cylinder (Fig. (C)). As the piston moves and reaches the end of its stroke, the internal pressure in the cylinder rises, causing the piston valve to open fully, and the air feeds rapidly into the cylinder (Fig. (B)).

Cylinder → Switching valve

Fig. (D)
(Stroke end)

The air in the cylinder initially opens the piston valve and the check valve and discharges rapidly through the switching valve. The fully opened piston valve closes as shown in Fig. (D) when the pressure in the cylinder is lower than the set pressure. Then the air passes through the check valve and becomes discharged (Fig. (D)). Thus, meter-in control of the cylinder speed is effected by the speed control valve of the supply conduit.

Dimensions

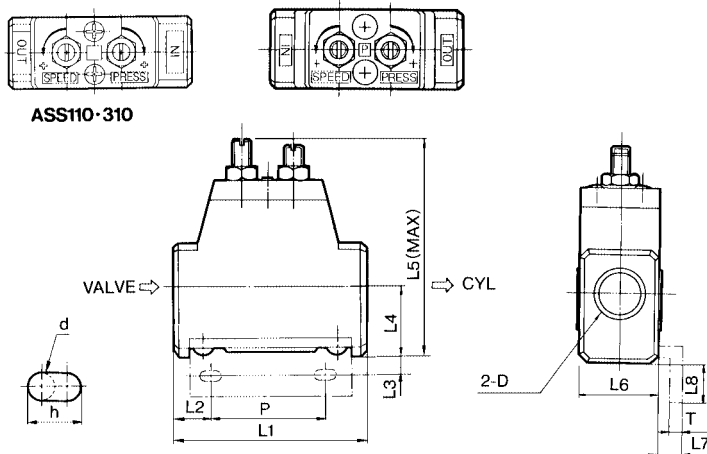

Model	D	L1	L2	L3	L4	L5	L6	L7	L8	P	d	h	T	
ASS100	ASS110	1/8	50	17	4	14	52	20	5	9	20	5	10	2
ASS300	ASS310	1/4, 3/8	63	16.5	5	23	73	26	6	12	30	6	12	3.2
ASS500	—	1/2, 3/4	90	30.5	6	27	99	38	6	13	35	7	14	2.3
ASS600	—	3/4, 1	112	26	6	31	116	46	6	14	65	7	14	3.2

Meter-out Control Type

Mounting method

Connect tubing directly to the cylinder with the IN side facing the directional control valve on the supply conduit (of the stroke that must be prevented from shooting out).

Note 1) If the tubing between the cylinder and the SSC valve is too long, it might not be possible to effect speed control during normal operation.

Note 2) The SSC valve cannot prevent quick extension if there is residual pressure in the cylinder.

Note 3) After the initial operation, make sure that the cylinder remains pressurized at the end of the stroke and that the cylinder has been filled with air before using the circuit to perform a normal operation.

Adjusting method

To adjust the meter-out control type, first adjust the cylinder speed for normal operation before adjusting the set pressure for preventing sudden extension.

Adjusting procedure

- In the normal operation state (in which one of the conduits is pressurized) adjust the cylinder speed to the prescribed speed by operating the cylinder speed adjustment set needle located on the IN side. Turn the cylinder speed adjustment set needle counterclockwise to increase the speed and clockwise to decrease the speed. After adjusting, tighten the lock nut. Keep the cylinder cushion needle as open as possible.
- Initially, turn the pressure adjustment set needle located on the OUT side clockwise to raise the set pressure. At the time of shipment, the set pressure is adjusted to approximately 0.2 MPa.

- Release the pressure in the cylinder once. Then, supply air, and adjust the pressure by turning the pressure adjustment set needle counterclockwise. This is to effect the meter-in control of the cylinder movement through the SSC valve's fixed throttle in order to prevent quick extension, and to rapidly feed air pressure after the piston has reached the end of its stroke. After adjusting, make sure to tighten the lock nut.

Note 1) Pressure set adjustments must be made in accordance with the operating conditions.

Note 2) Set pressure adjustment must be made during the initial operation after the pressure in the cylinder has been released.

Note 3) If the set pressure is adjusted too low, it will not be possible to prevent sudden extension during the initial operation. If it is adjusted too high, it will restrict the cylinder speed during normal operation.

- Again, verify the operation of the cylinder during normal operation. If there is a significant delay in starting the cylinder movement, causing it to lurch, or if the speed is extremely slow, tighten the speed controller on the exhaust side or the cylinder speed adjustment set needle of the SSC valve clockwise, or lower then set pressure of the supply side SSC valve. Then, readjust by performing steps eand ragain .

Note 1) Verify the cylinder movement during normal operation after it has been prevented from suddenly extending during the initial operation and the air pressure has been supplied sufficiently at the end of the stroke.

Mounting and Adjusting of SSC Valve

Mounting: Mount IN on the direction control valve side, and OUT on the cylinder side.

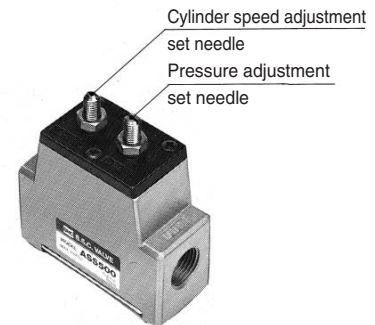

Bracket Part No.

Model	Part no.
ASS1□0	XT14-82-3-1
ASS3□0	XT14-105-5-1
ASS500	XT14-89-2-1
ASS600	XT14-85-2-1

Meter-in Control Type

Mounting method

Connect tubing to the supply conduit (on the side that requires a rapid supply of air at the stroke end) with the IN side facing the directional control valve.

Note 1) The longer the tubing of the cylinder, SSC valve, and speed controller, the longer is the delay during actuation.

Note 2) If a load is applied constantly, such as when the cylinder is mounted vertically, it is not possible to control the speed of the stroke in the same direction as that of the load.

Adjusting method

To adjust meter-in control, adjust the lurch prevention set pressure to high; then adjust the cylinder speed, and then the set pressure.

Adjusting procedure

- Initially, turn the pressure adjustment set needle located on the IN side clockwise to raise the set pressure. At the time of shipment, the set pressure is adjusted to approximately 0.2 MPa.
- To prevent the cylinder from moving at high speeds, turn the cylinder speed adjustment set needle located on the OUT side clockwise to decrease the cylinder speed.
- Next, operate the directional control valve repeatedly to move the cylinder, and adjust the cylinder speed adjustment set needle and the speed controller to achieve the prescribed cylinder speed. (If an SSC valve is used on both sides, perform the adjustment at the cylinder speed adjustment set needles on both sides.) After adjusting, tighten the lock nut. Keep the cylinder cushion needle on the side with the SSC valve as open as possible.
- Adjust the pressure adjustment set needle counterclockwise so that the cylinder moves, the cylinder speed is controlled by meter-in control, and the pressure is rapidly supplied to the cylinder after reaching the stroke end. After adjusting, tighten the lock nut.

Note 1) Do not turn the pressure adjustment set needle excessively counterclockwise to prevent the cylinder from suddenly extending.

AS

ASP

ASN

AQ

ASV

AK

ASS

ASR

ASF

Flow Control Equipment Precautions



Be sure to read before handling. Refer to pages 15-18-3 to 15-18-4 for Safety Instructions and Common Precautions on the products mentioned in this catalog, and refer to main text for more detailed precautions on every series.

Precautions

Selection

Warning

1. Products mentioned in this catalog are not designed for the use as stop valve with zero air leakage.

A certain amount of leakage is allowed in the product's specifications.

Mounting

Warning

1. Check that the lock nut is tightened.
A loose lock nut may cause actuator speed changes.
2. Confirm the degree of rotation of the needle valve.
Products mentioned in this catalog are retainer type so that the needle is not removed completely. Over rotation will cause damage.
3. Do not use tools such as pliers to rotate the handle.
It can cause idle rotation of the handle or damage.
4. Confirm air flow direction.
Mounting backwards is dangerous, because the speed adjustment needle will not work and the actuator may lurch suddenly.
5. Adjust needle by opening the needle slowly after having closed it completely.
Loose needle valves may cause unexpected sudden actuator extension. When needle valve is turned clockwise, it is closed and cylinder speed decreases. When needle valve is turned counter clockwise, it is open and cylinder speed increases.
6. Do not apply excessive force or shock to the body or fittings with an impact tool.
It can cause damage or air leakage.

Series AS-F/FE/FG/FM

Selection

Warning

1. Confirm that PTFE can be used in application.

PTFE powder (Polytetrafluoroethylene resin) is included in the seal material. Confirm if the use of it may cause any adverse effect in the system.

Mounting

Warning

1. To install/remove the Flow Control Equipment, tighten/loosen at wrench flat B as close to the thread as possible using the appropriate wrench.

Do not apply torque at other points as the product may be damaged. Rotate Body A manually for positioning after installation.

2. Do not use universal type fittings for applications involving continuous rotation.

The fitting section may be damaged.

Tightening Torque

Caution

1. The tightening torque for pipe fittings is as shown in the table. As a rule, they should be tightened 2 to 3 turns with a tool after first tightening by hand.

Be careful not to cause damage by over-tightening.

Male thread	Suitable screw torque (N·m)	Hexagon width across flats (mm)	Adjustable spanner nominal (mm)
M3	1/4	4.5	—
M5 10/32-UNF	1/6 turn after hand tightening	8	100
1/8	7 to 9	14	150
1/4	12 to 14	17	200
3/8	22 to 24	21	200
1/2	28 to 30	24	200

Lock Nut Tightening Torque

Caution

1. Suitable screw torque for a hexagon lock nut is shown in the table below. For standard installation, turn 15 to 30° using tool, after fastening by hand. Pay attention not to over torque the product.

Body size	Suitable screw torque (N·m)
M3	0.07
M5	0.3
1/8	1
1/4	1.5
3/8	4
1/2	10

⚠ Precautions

Handling of One-touch Fittings

⚠ Caution

1. Refer to page 15-1-11 for One-touch Fitting.

Series ASD

Operation

⚠ Caution

1. Single acting cylinder

When controlling a single acting cylinder, the cylinder's return speed will differ depending on the operating conditions. Operate after confirming the maximum return speeds shown in the table below.

Speed Controller	Cylinder	Solenoid valve	Tubing	Silencer	Maximum return speed (mm/s)		
					100	200	300
ASD230F	CJ2	VJ500	TU0604 1 m	AN110-01	Cylinder size		
					ø6		
					ø10		
ASD330F	CM2	VZ500	TU0604 1 m	AN110-01	Cylinder size		
					ø16		
					ø20		
					ø25		
					ø32		

- <Operating conditions>
- Cylinder extension speed: 100 mm/s
 - Meter-out needle fully open

* Values at 0.5 MPa and 20°C.

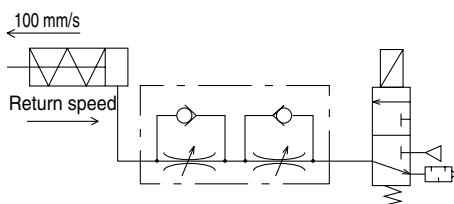

(Reference) Recommended circuit for high return speed

When low extension speed and high return speed are desired, the following circuit using 3-port is recommended.

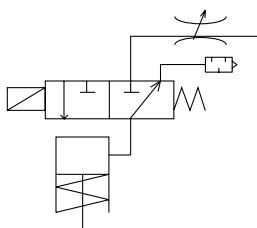

Note) Use Series AS-F with -X214 for the throttle valve.

Series ASN2

Selection

⚠ Warning

1. Inappropriate Circuits

(a) "Perfect Valve"
(VF66□□, VS7-6-FPG, VS7-8-FPG)

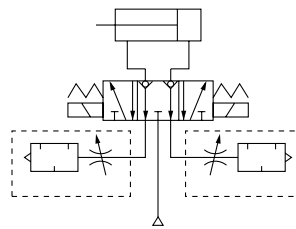

Residual pressure behind the exhaust needle may cause check valve malfunction in the "Perfect Valve".

(b) Pilot check valve between Actuator and Valve

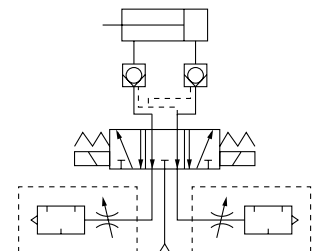

Residual pressure behind the exhaust needle may cause check valve to malfunction.

Mounting

⚠ Caution

1. If installing flow controls to valve ports, interference may occur with the fittings. Please consult the catalog before installing.

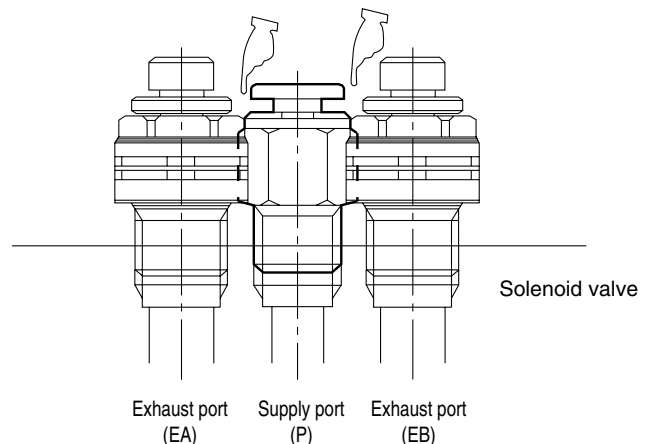

Fig. Example of the interference with fittings

Series AK

⚠ Caution

1. Vibrations may generate due to operating conditions, etc., even if the specifications are in the range mentioned in the catalog. Please consult with SMC.

2. Cracking pressure is a pressure at which the valve starts opening and not a pressure at which the valve is fully open.

⚠ Precautions

Series ASS

Selection

⚠ Warning

1. **Use meter-out controlling type after confirming the initial speed to prevent sudden actuator extension.**

Due to its specifications, the extension preventing function does not have speed control capability so that adjustments are limited. Use the meter-in controlling type if desired speed is less than set speed.

2. **Circuit pressure remaining in cylinder is not usable.**

Extension prevention works when pressure has been exhausted in cylinder. Therefore, prevent the extension by meter-in control using a speed controller in such a case.

Mounting

⚠ Warning

1. **Install Actuator and SSC valve as close as possible.**

Extensions prevention in the initial operation and standard speed control may not function.

2. **Do not use for relatively small capacity actuators. i.e. short stroke cylinders (less than 100 mm), rotary actuators, etc.**

SSC valve may not properly operate.

3. **Use in load factor less than 50%.**

Speed control under normal operations may not function.

Series AQ

Operation

⚠ Caution

1. **In the following cases, insufficient exhaust or vibration may cause noise.**

- a) With residual pressure or back pressure on the IN side
- b) When the differential pressure between the IN and OUT sides is smaller than the min. operating pressure.

Series ASP

Caution on Design

⚠ Warning

1. **This product cannot be used for accurate and precise intermediate stops of the actuator.**

Due to the compressibility of air as a fluid, the actuator will continue to move until it reaches a position of pressure balance, even though the pilot check valve closes with an intermediate stop signal.

2. **This product cannot be used to hold a stop position for an extended period of time.**

Pilot check valves and actuators are not guaranteed for zero air leakage. Therefore, it is sometimes not possible to hold a stop position for an extended period of time. In the event that holding for an extended time is necessary, a mechanical means for holding should be devised.

3. **Consider the release of residual pressure.**

Actuators may move suddenly due to residual pressure, which can be dangerous during maintenance procedures.

Selection

⚠ Warning

1. **When used in a balance control circuit, there are instances in which the check valve cannot release, even though the pilot pressure is 50% of the operating pressure. In these cases, the pilot pressure should be the same as the operating pressure.**

2. **For reference, SMC has conducted endurance tests in which ON, OFF operation of the check valve was performed at the maximum operating pressure, with a confirmed endurance of 10 million operations. Since the tests were performed under limited conditions, use caution in evaluating the results.**



Safety Instructions

These safety instructions are intended to prevent a hazardous situation and/or equipment damage. These instructions indicate the level of potential hazard by labels of "Caution", "Warning" or "Danger". To ensure safety, be sure to observe ISO 4414 ^{Note 1)}, JIS B 8370 ^{Note 2)} and other safety practices.

 **Caution** : Operator error could result in injury or equipment damage.

 **Warning** : Operator error could result in serious injury or loss of life.

 **Danger** : In extreme conditions, there is a possible result of serious injury or loss of life.

Note 1) ISO 4414: Pneumatic fluid power--General rules relating to systems.

Note 2) JIS B 8370: General Rules for Pneumatic Equipment

Warning

1. The compatibility of pneumatic equipment is the responsibility of the person who designs the pneumatic system or decides its specifications.

Since the products specified here are used in various operating conditions, their compatibility for the specific pneumatic system must be based on specifications or after analysis and/or tests to meet your specific requirements. The expected performance and safety assurance will be the responsibility of the person who has determined the compatibility of the system. This person should continuously review the suitability of all items specified, referring to the latest catalog information with a view to giving due consideration to any possibility of equipment failure when configuring a system.

2. Only trained personnel should operate pneumatically operated machinery and equipment.

Compressed air can be dangerous if an operator is unfamiliar with it. Assembly, handling or repair of pneumatic systems should be performed by trained and experienced operators.

3. Do not service machinery/equipment or attempt to remove components until safety is confirmed.

1. Inspection and maintenance of machinery/equipment should only be performed once measures to prevent falling or runaway of the driver objects have been confirmed.
2. When equipment is to be removed, confirm the safety process as mentioned above. Cut the supply pressure for this equipment and exhaust all residual compressed air in the system.
3. Before machinery/equipment is restarted, take measures to prevent shooting-out of cylinder piston rod, etc.

4. Contact SMC if the product is to be used in any of the following conditions:

1. Conditions and environments beyond the given specifications, or if product is used outdoors.
2. Installation on equipment in conjunction with atomic energy, railway, air navigation, vehicles, medical equipment, food and beverages, recreation equipment, emergency stop circuits, clutch and brake circuits in press applications, or safety equipment.
3. An application which has the possibility of having negative effects on people, property, or animals, requiring special safety analysis.



Common Precautions

Be sure to read before handling.

For detailed precautions on every series, refer to main text.

Selection

Warning

1. Confirm the specifications.

Products represented in this catalog are designed for use in compressed air applications only (including vacuum), unless otherwise indicated.

Do not use the product outside their design parameters.

Please contact SMC when using the products in applications other than compressed air (including vacuum).

Mounting

Warning

1. Instruction manual

Install the products and operate them only after reading the instruction manual carefully and understanding its contents. Also keep the manual where it can be referred to as necessary.

2. Securing the space for maintenance

When installing the products, please allow access for maintenance.

3. Tightening torque

When installing the products, please follow the listed torque specifications.

Piping

Caution

1. Before piping

Make sure that all debris, cutting oil, dust, etc. are removed from the piping.

2. Wrapping of pipe tape

When screwing piping or fittings into ports, ensure that chips from the pipe threads or sealing material do not get inside the piping. Also, when the pipe tape is used, leave 1.5 to 2 thread ridges exposed at the end of the threads.

Air Supply

Warning

1. Operating fluid

Please consult with SMC when using the product in applications other than compressed air (including vacuum).

Regarding products for general fluid, please ask SMC about applicable fluids.

2. Install an air dryer, aftercooler, etc.

Excessive condensate in a compressed air system may cause valves and other pneumatic equipment to malfunction.

Installation of an air dryer, after cooler etc. is recommended.

3. Drain flushing

If condensate in the drain bowl is not emptied on a regular basis, the bowl will over flow and allow the condensate to enter the compressed air lines.

If the drain bowl is difficult to check and remove, it is recommended that a drain bowl with the auto-drain option be installed.

For compressed air quality, refer to "Air Preparation Equipment" catalog.

4. Use clean air

If the compressed air supply is contaminated with chemicals, synthetic materials, corrosive gas, etc., it may lead to break down or malfunction.

Operating Environment

Warning

1. Do not use in environments where the product is directly exposed to corrosive gases, chemicals, salt water, water or steam.

2. Do not expose the product to direct sunlight for an extended period of time.

3. Do not use in a place subject to heavy vibrations and/or shocks.

4. Do not mount the product in locations where it is exposed to radiant heat.

Maintenance

Warning

1. Maintenance procedures are outlined in the operation manual.

Not following proper procedures could cause the product to malfunction and could lead to damage to the equipment or machine.

2. Maintenance work

If handled improperly, compressed air can be dangerous.

Assembly, handling and repair of pneumatic systems should be performed by qualified personnel only.

3. Drain flushing

Remove drainage from air filters regularly. (Refer to the specifications.)

4. Shut-down before maintenance

Before attempting any kind of maintenance make sure the supply pressure is shut of and all residual air pressure is released from the system to be worked on.

5. Start-up after maintenance and inspection

Apply operating pressure and power to the equipment and check for proper operation and possible air leaks. If operation is abnormal, please verify product set-up parameters.

6. Do not make any modifications to be product.

Do not take the product apart.

Quality Assurance Information (ISO 9001, ISO 14001)

Reliable quality of products in the global market

To enable our customers throughout the world to use our products with even greater confidence, SMC has obtained certification for international standards “ISO 9001” and “ISO 14001”, and created a complete structure for quality assurance and environmental controls. SMC products pursue to meet its customers’ expectations while also considering company’s contribution in society.

Quality management system ISO 9001

This is an international standard for quality control and quality assurance. SMC has obtained a large number of certifications in Japan and overseas, providing assurance to our customers throughout the world.



Environmental management system ISO 14001

This is an international standard related to environmental management systems and environmental inspections. While promoting environmentally friendly automation technology, SMC is also making diligent efforts to preserve the environment.



SMC’s quality control system



Quality policies



Quality control activities

SMC Product Conforming to Inter

SMC products complying with EN/ISO, CSA/UL standards are supporting



The CE mark indicates that machines and components meet essential requirements of all the EC Directives applied.

It has been obligatory to apply CE marks indicating conformity with EC Directives when machines and components are exported to the member Nations of the EU.

Once "A manufacturer himself" declares a product to be safe by means of CE marking (declaration of conformity by manufacturer), free distribution inside the member Nations of the EU is permissible.

■ CE Mark

SMC provides CE marking to products to which EMC and Low Voltage Directives have been applied, in accordance with CETOP (European hydraulics and pneumatics committee) guide lines.

■ As of February 1998, the following 18 countries will be obliged to conform to CE mark legislation

Iceland, Ireland, United Kingdom, Italy, Austria, Netherlands, Greece, Liechtenstein, Sweden, Spain, Denmark, Germany, Norway, Finland, France, Belgium, Portugal, Luxembourg

■ EC Directives and Pneumatic Components

• Machinery Directive

The Machinery Directive contains essential health and safety requirements for machinery, as applied to industrial machines e.g. machine tools, injection molding machines and automatic machines. Pneumatic equipment is not specified in Machinery Directive. However, the use of SMC products that are certified as conforming to EN Standards, allows customers to simplify preparation work of the Technical Construction File required for a Declaration of Conformity.

• Electromagnetic Compatibility (EMC) Directive

The EMC Directive specifies electromagnetic compatibility. Equipment which may generate electromagnetic interference or whose function may be compromised by electromagnetic interference is required to be immune to electromagnetic affects (EMS/immunity) without emitting excessive electromagnetic affects (EMI/emission).

• Low Voltage Directive

This directive is applied to products, which operate above 50 VAC to 1000 VAC and 75 VDC to 1500 VDC operating voltage, and require electrical safety measures to be introduced.

• Simple Pressure Vessels Directive

This directive is applied to welded vessels whose maximum operating pressure (PS) and volume of vessel (V) exceed 50 bar/L. Such vessels require EC type examination and then CE marking.

national Standards

you to comply with EC directives and CSA/UL standards.



■ CSA Standards & UL Standards

UL and CSA standards have been applied in North America (U.S.A. and Canada) symbolizing safety of electric products, and are defined to mainly prevent danger from electric shock or fire, resulting from trouble with electric products. Both UL and CSA standards are acknowledged in North America as the first class certifying body. They have a long experience and ability for issuing product safety certificate. Products approved by CSA or UL standards are accepted in most states and governments beyond question.

Since CSA is a test certifying body as the National Recognized Testing Laboratory (NRTL) within the jurisdiction of Occupational Safety and Health Administration (OSHA), SMC was tested for compliance with CSA Standards and UL Standards at the same time and was approved for compliance with the two Standards. The above CSA NRTL/C logo is described on a product label in order to indicate that the product is approved by CSA and UL Standards.

■ TSSA (MCCR) Registration Products

TSSA is the regulation in Ontario State, Canada. The products that the operating pressure is more than 5 psi (0.03 MPa) and the piping size is bigger than 1 inch. fall into the scope of TSSA regulation.

Products conforming to CE Standard



With CE symbol for simple visual recognition

In this catalog each accredited product series is indicated with a CE mark symbol. However, in some cases, every available models may not meet CE compliance. Please visit our web site for the latest selection of available models with CE mark.

<http://www.smcworld.com>

SMC's Global Service Network

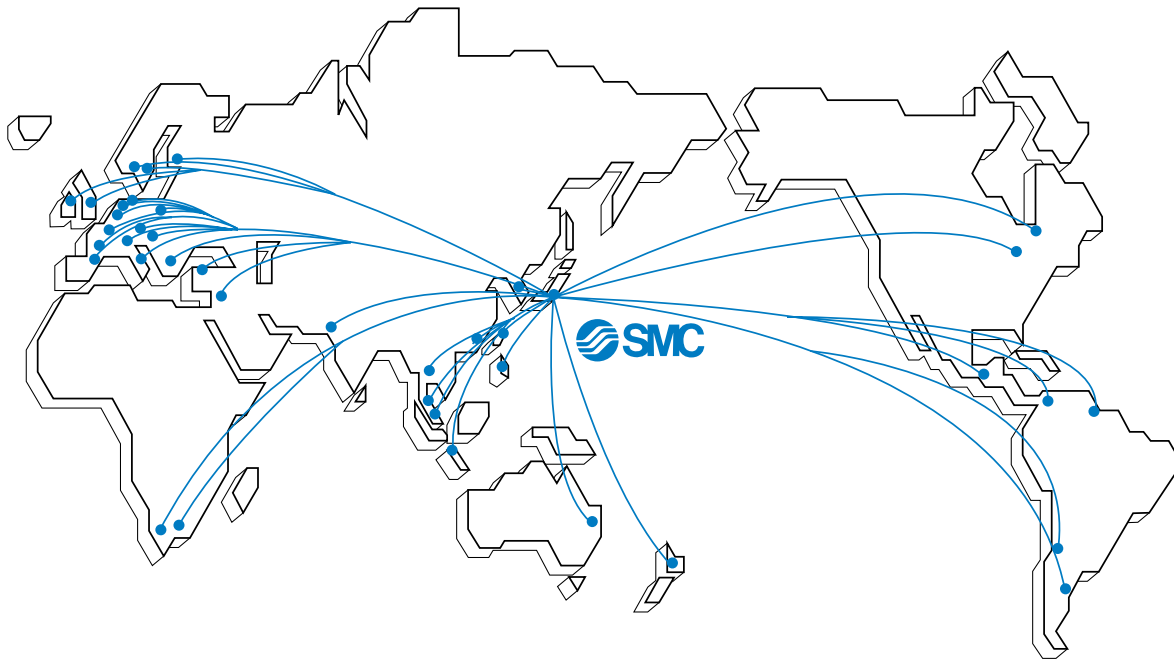

America

U.S.A. **SMC Corporation of America**

3011 North Franklin Road Indianapolis, IN 46226, U.S.A.
TEL: 317-899-4440 FAX: 317-899-3102

CANADA **SMC Pneumatics (Canada) Ltd.**

6768 Financial Drive Mississauga, Ontario, L5N 7J6 Canada
TEL: 905-812-0400 FAX: 905-812-8686

MEXICO **SMC Corporation (Mexico), S.A. DE C.V.**

Carr. Silao-Trejo K.M. 2.5 S/N, Predio San Jose del Duranzo
C.P. 36100, Silao, Gto., Mexico
TEL: 472-72-2-55-00 FAX: 472-72-2-59-44/2-59-46

CHILE **SMC Pneumatics (Chile) S.A.**

Av. La Montaña 1,115 km. 16,5 P. Norte Parque
Industrial Valle Grande, Lampa Santiago, Chile
TEL: 02-270-8600 FAX: 02-270-8601

ARGENTINA **SMC Argentina S.A.**

Teodoro Garcia 3860 (1427) Buenos Aires, Argentina
TEL: 011-4555-5762 FAX: 011-4555-5762

BOLIVIA **SMC Pneumatics Bolivia S.R.L.**

Avenida Beni Numero 4665
Santa Cruz de la Sierra-Casilla de Correo 2281, Bolivia
TEL: 591-3-3428383 FAX: 591-3-3449900

VENEZUELA **SMC Neumatica Venezuela S.A.**

Apartado 40152, Avenida Nueva Granada, Edificio Wanlac,
Local 5, Caracas 1040-A, Venezuela
TEL: 2-632-1310 FAX: 2-632-3871

PERU (Distributor) **IMPECO Automatizacion Industrial S.A.**

AV. Canevaro 752, Lince, Lima, Peru
TEL: 1-471-6002 FAX: 1-471-0935

URUGUAY (Distributor) **BAKO S.A.**

Galicia 1650 esq. Gaboto C.P. 11200, Montevideo, Uruguay
TEL: 2-401-6603 FAX: 2-409-4306

BRAZIL **SMC Pneumaticos Do Brasil Ltda.**

Rua. Dra. Maria Fidelis, nr. 130, Jardim Piraporinha-Diadema-S.P.
CEP: 09950-350, Brasil
TEL: 11-4051-1177 FAX: 11-4071-6636

COLOMBIA (Distributor) **Airmatic Ltda.**

Calle 18 69-05 Apart. Aereo 081045 Santa Fe de Bogotá, Colombia
TEL: 1-424-9240 FAX: 1-424-9260

Europe

U.K. **SMC Pneumatics (U.K.) Ltd.**

Vincent Avenue, Crownhill, Milton Keynes, MK8 0AN, Buckinghamshire, U.K.
TEL: 01908-563888 FAX: 01908-561185

GERMANY **SMC Pneumatik GmbH**

Boschring 13-15 D-63329 Egelsbach, Germany
TEL: 06103-4020 FAX: 06103-402139

ITALY **SMC Italia S.p.A.**

Via Garibaldi 62 I-20061 Carugate Milano, Italy
TEL: 02-9271365 FAX: 02-9271365

FRANCE **SMC Pneumatique S.A.**

1 Boulevard de Strasbourg, Parc Gustave Eiffel, Bussy Saint Georges, F-77600
Marne La Vallee Cedex 3 France
TEL: 01-64-76-10-00 FAX: 01-64-76-10-10

SWEDEN **SMC Pneumatics Sweden AB**

Ekhagsvägen 29-31, S-141 05 Huddinge, Sweden
TEL: 08-603-07-00 FAX: 08-603-07-10

SWITZERLAND **SMC Pneumatik AG**

Dorfstrasse 7, Postfach 117, CH-8484 Weisslingen, Switzerland
TEL: 052-396-3131 FAX: 052-396-3191

AUSTRIA **SMC Pneumatik GmbH (Austria)**

Girakstrasse 8, A-2100 Korneuburg, Austria
TEL: 0-2262-6228-0 FAX: 0-2262-62285

SPAIN **SMC España, S.A.**

Zuazobidea 14 Pol. Ind. Júndiz 01015 Vitoria, Spain
TEL: 945-184-100 FAX: 945-184-510

IRELAND **SMC Pneumatics (Ireland) Ltd.**

2002 Citywest Business Campus, Naas Road, Saggart, Co. Dublin, Ireland
TEL: 01-403-9000 FAX: 01-466-0385

NETHERLANDS (Associated company) **SMC Pneumatics BV**

De Ruyterkade 120, NL-1011 AB Amsterdam, Netherlands
TEL: 020-5318888 FAX: 020-5318880

GREECE (Distributor) **S.Parianopoulos S.A.**

7, Konstantinoupoleos Street 11855 Athens, Greece
TEL: 01-3426076 FAX: 01-3455578

DENMARK **SMC Pneumatik A/S**

Knudsminde 4 B DK-8300
Odder, Denmark
TEL: 70252900 FAX: 70252901

Europe

FINLAND **SMC Pneumatics Finland OY**

PL72, Tiistinniityntie 4, SF-02231 ESP00, Finland
TEL: 09-8595-80 FAX: 09-8595-8595

NORWAY **SMC Pneumatics Norway A/S**

Vollsveien 13C, Granfoss Næringspark N-1366 LYSAKER, Norway
TEL: 67-12-90-20 FAX: 67-12-90-21

BELGIUM (Distributor) **SMC Pneumatics N.V./S.A.**

Nijverheidsstraat 20 B-2160 Wommelgem Belguim
TEL: 03-355-1464 FAX: 03-355-1466

POLAND **SMC Industrial Automation Polska Sp.z.o.o.**

ul. Konstruktorska 11A, PL-02-673 Warszawa, Poland
TEL: 022-548-5085 FAX: 022-548-5087

TURKEY (Distributor) **Entek Pnömatik San.ve Tic. Ltd. Sti**

Perpa Tic. Merkezi Kat:11 No.1625 80270 Okmeydani Istanbul, Türkiye
TEL: 0212-221-1512 FAX: 0212-221-1519

RUSSIA **SMC Pneumatik LLC.**

36/40 Sredny prospect V.O. St. Petersburg 199004, Russia
TEL: 812-118-5445 FAX: 812-118-5449

CZECH **SMC Industrial Automation CZ s.r.o.**

Hudcova 78a, CZ-61200 Brno, Czech Republic
TEL: 05-4121-8034 FAX: 05-4121-8034

HUNGARY **SMC Hungary Ipari Automatizálási kft.**

Budafoki ut 107-113 1117 Budapest
TEL: 01-371-1343 FAX: 01-371-1344

ROMANIA **SMC Romania S.r.l.**

Str. Frunzei, Nr. 29, Sector 2, Bucharest, Romania
TEL: 01-3205111 FAX: 01-3261489

SLOVAKIA **SMC Priemyselná automatizácia, s.r.o.**

Nova 3, SK-83103 Bratislava
TEL: 02-4445-6725 FAX: 02-4445-6028

SLOVENIA **SMC Industrijska Avtomatila d.o.o.**

Grajski trg 15, SLO- 8360 Zuzemberk, Slovenia
TEL: 07388-5240 FAX: 07388-5249

LATVIA **SMC Pneumatics Latvia SIA**

Šmerļa ielā 1-705, Rīga LV-1006
TEL: 777 94 74 FAX: 777 94 75

SOUTH AFRICA (Distributor) **Hyflo Southern Africa (Pty.) Ltd.**

P.O.Box 240 Paardeneiland 7420 South Africa
TEL: 021-511-7021 FAX: 021-511-4456

EGYPT (Distributor) **Saadani Trading & Ind. Services**

15 Sebaai Street, Miami 21411 Alexandria, Egypt
TEL: 3-548-50-34 FAX: 3-548-50-34

Oceania/Asia

AUSTRALIA **SMC Pneumatics (Australia) Pty.Ltd.**

14-18 Hudson Avenue Castle Hill NSW 2154, Australia
TEL: 02-9354-8222 FAX: 02-9894-5719

NEW ZEALAND **SMC Pneumatics (New Zealand) Ltd.**

8C Sylvia Park Road Mt.Wellington Auckland, New Zealand
TEL: 09-573-7007 FAX: 09-573-7002

TAIWAN **SMC Pneumatics (Taiwan) Co.,Ltd.**

17, Lane 205, Nansan Rd., Sec.2, Luzhu-Hsiang, Taoyuan-Hsien, TAIWAN
TEL: 03-322-3443 FAX: 03-322-3387

HONG KONG **SMC Pneumatics (Hong Kong) Ltd.**

29/F, Clifford Centre, 778-784 Cheung, Sha Wan Road, Lai Chi Kok, Kowloon, Hong Kong
TEL: 2744-0121 FAX: 2785-1314

SINGAPORE **SMC Pneumatics (S.E.A.) Pte. Ltd.**

89 Tuas Avenue 1, Jurong Singapore 639520
TEL: 6861-0888 FAX: 6861-1889

PHILIPPINES **SHOKETSU SMC Corporation**

Unit 201 Common Goal Tower, Madrigal Business Park, Ayala Alabang Muntinlupa, Philippines
TEL: 02-8090565 FAX: 02-8090586

MALAYSIA **SMC Pneumatics (S.E.A.) Sdn. Bhd.**

Lot 36 Jalan Delima1/1, Subang Hi-Tech Industrial Park, Batu 3 40000 Shah Alam Selangor, Malaysia
TEL: 03-56350590 FAX: 03-56350602

SOUTH KOREA **SMC Pneumatics Korea Co., Ltd.**

Woolim e-BIZ Center (Room 1008), 170-5, Guro-Dong, Guro-Gu, Seoul, 152-050, South Korea
TEL: 02-3219-0700 FAX: 02-3219-0702

CHINA **SMC (China) Co., Ltd.**

7 Wan Yuan St. Beijing Economic & Technological Development Zone 100176, China
TEL: 010-67882111 FAX: 010-67881837

THAILAND **SMC Thailand Ltd.**

134/6 Moo 5, Tiwanon Road, Bangkadi, Amphur Muang, Patumthani 12000, Thailand
TEL: 02-963-7099 FAX: 02-501-2937

INDIA **SMC Pneumatics (India) Pvt. Ltd.**

D-107 to 112, Phase-2, Extension, Noida, Dist. Gautaim Budh Nagar, U.P. 201 305, India
TEL: (0120)-4568730 FAX: 0120-4568933

INDONESIA (Distributor) **P.T. Riyadi Putera Makmur**

Jalan Hayam Wuruk Komplek Glodok Jaya No. 27-28 Jakarta 11180 Indonesia
TEL: 021-625 5548 FAX: 021-625 5888

PAKISTAN (Distributor) **Jubilee Corporation**

First Floor Mercantile Centre, Newton Road Near Boulton Market P.O. Box 6165 Karachi 74000 Pakistan
TEL: 021-243-9070/8449 FAX: 021-241-4589

ISRAEL (Distributor) **Baccara Automation Control**

Kvutza Geva 18915 Israel
TEL: 04-653-5960 FAX: 04-653-1445

SAUDI ARABIA (Distributor) **Assaggaff Trading Est.**

P.O. Box 3385 Al-Amir Majed Street, Jeddah-21471, Saudi Arabia
TEL: 02-6761574 FAX: 02-6708173