

# LASER MARKING SYSTEMS

## Product Guide

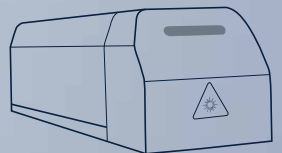
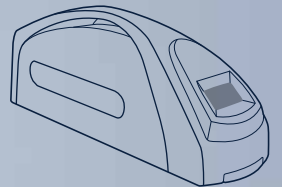
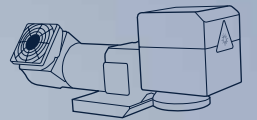
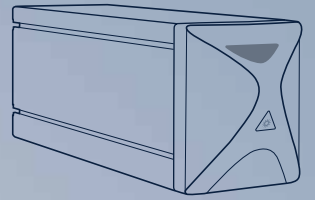
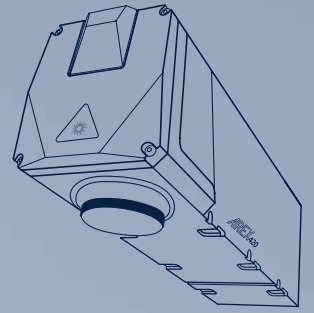

# LASER MARKING PRODUCTS & SOLUTIONS

## COMPREHENSIVE PRODUCT RANGE COMBINED WITH EXCELLENT LASER MARKING MANUFACTURING EXPERTISE

Over 20 years experience in the production of industrial laser sources has enabled Datalogic Laser Marking to create the most comprehensive product portfolio in the marketplace by offering solutions throughout a wide range of applications.

Laser Marking products provide value added marking solutions for the Automotive, Aerospace, Industrial Electronics, Metal tooling, precision mechanics and Medical & Surgical devices.

Laser Marking products are offered in the three main laser technologies: Fiber Laser, Solid State Laser and Co2 Laser and cover a wide range of applications on almost any material, fulfilling every customer need for permanent marking.

Powerful, best-in-class control software operates with any model configurations and laser technologies: a unique HMI control platform, easy to use and install, with enhanced customization capabilities.

### SOLID STATE LASER MARKER VLASE SERIES & ULYXE

The long history of market leading Solid State technologies has enabled Datalogic to create the most comprehensive product portfolio in the marketplace by offering solutions with a wide variety of applications in multiple wavelengths.

DLA product portfolio offers industrial grade solutions for Infrared Green and UV in a wide power range, and an innovative ultra-compact, all-in-one laser marker for level-entry application.

#### Solid State key features:

- Best-in-class laser peak power
- Three different wavelengths for best result even on highly reflective or high stability materials
- Excellent beam quality and marking accuracy
- Low thermal footprint to ensure high contrast on thermoplastic materials and low impact on thermal sensitive components

### FIBER LASER MARKER UNIQ & AREX400 SERIES

Innovative design and performances combined with state-of-art technology, for the most demanding applications and industries.

Datalogic's AREX and UniQ product lines are robust and reliable and cost effective, fiber laser technology is the he solution of choice for high-end applications where speed, quality and efficiency are critical.

Fixed pulswidth models (100ns) ensure great thermal effect on metal materials, for high efficiency metal annealing and engraving.

Adjustable pulswidth model (4- 250 ns) based on MOPA technology offers the highest level of flexibility on heat sensitive materials, and ensure the highest contrast on thermoplastic materials.

#### Fiber Laser key features:

- Ultra-compact, rugged IP64 scanhead fully protected against dust, water and oil droplets
- Low noise level
- Fast turn-on, zero warmup
- High stability, reliable process
- Excellent on metal and plastic surfaces

### CO<sub>2</sub> LASER MARKER EOX SERIES

CO<sub>2</sub> laser technology is still the best solution to provide permanent laser marking for industrial traceability and coding on paper, carton, organic materials, coated/painted materials and plastic.

Long wavelength (10.600nm) ensure good results even on glass, rubber, food, wood and many other materials.

#### CO<sub>2</sub> Laser key features:

- Excellent on paper, cardboard, wood and plastics
- Marking on the fly compatible with variable speed
- Suitable for coding from medium to high throughput production lines

## ONE.RACK MARKING CONTROLLER

Laser marker setup and operation are made easy with the Embedded Marker Controller platform (EMC) and LIGHTER Suite.

One single rack, 19 inch, 2,5 U, offer standardized design and I/O connections to enable integrators to freely choose between DLA's three main laser technology (DPSSL, FIBER, CO<sub>2</sub>) without any connections or wiring hassle.

"ONE.RACK" design drastically simplifies laser integration machine design. All you need for your marking application is now included: 100-240 VAC power supply, Embedded Laser controller with 4 independent axis controls (X,Y,Z, Rotating axis) to implement multi-layers and rotating marking, dedicated encoder input is applied for Marking On Fly (MOF) even in accelerated and variable speed conditions.

All the units are equipped with Teamviewer host to ensure real time remote support.

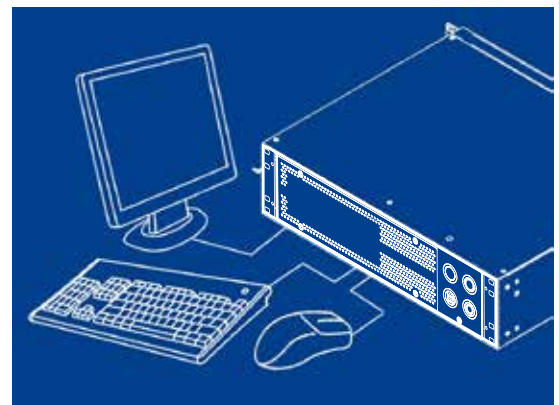

# LASER MARKING SOFTWARE

## LIGHTER SUITE, THE LASER MARKING SOFTWARE FOR ALL DATALOGIC LASER MARKING PRODUCTS



LIGHTER is a versatile laser marking Software Suite dedicated to OEMs and Machine builders to develop a complete and cost effective Laser Marking Station, based on embedded hardware and software resources.

With its innovative software functions and concepts, LIGHTER

Suite represents an important step ahead in marking software arena by setting new standards for an easier integration and ease of use. LIGHTER Suite combines advanced graphical and editing features, laser controls configuration and diagnostic with a production-oriented interface for easy and safe daily marking operations.

Lighter Suite is composed by a Laser Editor, a powerful and intuitive software to create, import or edit vectorial graphics, logos or serialization codes, and Laser Engine a robust and reliable task manager to execute stored layouts and programs.



Available with the LIGHTER software suite the new **MARVIS (Mark Read Verify Integrated**

**Solution)** is the new Datalogic's solution for laser marking parts traceability.

**LIGHTER MARVIS™** represents an important step-a-head in the MARK & VALIDATE application setting a new standard in term of ease integration and ease of use.

Thanks to innovative approach LIGHTER MARVIS merges the capability to control both the full family of DATALOGIC Laser Markers and the entire family of MATRIX code readers, in a user friendly, simplified fully graphical interface.

### Advanced Editing and Formatting Functions

- Wide coding library with 100+ different barcode symbologies and sub-types
- Import bitmap and vector formats DXF, DWG, PLT, PDF, AI, SVG, BMP, JPG, GIF, TIFF and many more
- Windows® True Type import tools
- Contextual Property Browser for quick and easy settings of graphics and laser parameters
- Advanced editing tools and Node Editor
- Filling and hatching of objects and pattern structures with various styles
- Date, Time, Shift, serial codes
- Array Marking
- Extended layer in combination with Axis controller
- Grey Tone marking

### Automation Capability

- 4 independent Mechanical axis control (X,Y,Z,R)
- User controlled general purpose I/O
- Built-in-marking on the fly
- Sequential programming
- ID reader integration with LIGHTER MARVIS option

### Programmable Interface and Protocols

- Built-in IDE (Integrated Development Environment) based on JavaScript provides users a full set of tools to be used for extremely flexible customization.
- ActiveX support to create customized applications and user interfaces via Ethernet.
- RS232, TCP/IP, EthernetIP and Profinet embedded support.

### Software Upgrades

Datalogic is committed to preserve the value of your laser investment keeping your system updated. Regular updated and new features are available on our web site.

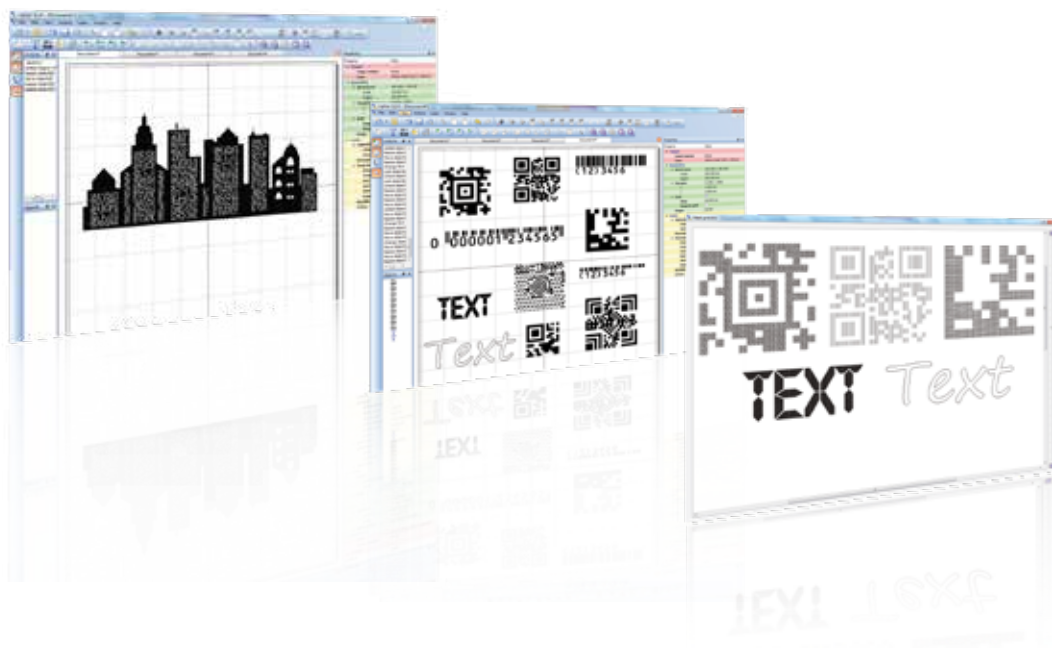

# VLASE SERIES

**VLASE** combines the long production experience of high performance and quality Diode Pumped Solid State (DPSS) laser sources with the flexibility and performances of EMC controller.

VLASE laser markers use the **state-of-the-art End Pumped Coupling Technology**, the most efficient and reliable solution for diode pumped solid state laser sources to provide **excellent beam quality, high peak power and short pulse-width**.

Solid State laser technology is recognized as the best solution to ensure high marking quality results even in difficult application such as high reflectivity or heat sensitive materials, un-doped or high stability plastic and hard-to-mark components.

**Designed for demanding 24H7 processes**, VLASE Series offers unparalleled performance and represents the ideal solution for direct part marking in any market segment including automotive, electronics, packaging, as well as in medical surgical tools marking and other applications



## VLASE IR

The VLASE IR is a DPSS air-cooled laser marking source @1064nm, available in 10 and 20W.

Excellent beam quality, necessary for marking a broad range of materials, is one of the leading characteristics of the VLASE IR laser sources.

### Applications

- Metal marking: steel, stainless steel, iron, titanium, carbide, brass, (bare, coated, anodized)
- Color enhanced plastic
- Thermo plastic (ABS, PP, PES, PET, PPMA)

## VLASE UV

The VLASE UV source exploits the extensive experience and success of the DPSS family and is based on the optomechanical architecture of Third Harmonic Generation (THG).

The VLASE UV wavelength produces less mechanical distortion and less heat affected zones (HAZ) in comparison with longer laser wavelengths.

The extreme performance of this laser source makes it ideal for the demanding marking and material process applications, such as glass and nondoped plastics in automotive, healthcare, aeronautic, solar & electronics among many other applications.

### Applications

- High stability, "non-doped" plastic marking
- High Density Polyethylene (HDPE) marking
- Medical & surgical plastic marking
- Silicon scribing
- Ceramic & glass marking

## VLASE GREEN

The VLASE GREEN laser sources and markers operate on the VL-IR platform and use Second Harmonic Generation (SHG) in an intracavity architecture, which maximizes system efficiency.

The VLASE GREEN wavelength results in a lower heat affected zone (HAZ) compared with an infrared laser, smaller bema size and higher resolution.

This laser source offers significant advantages in marking applications with materials such as plastics that do not interact with infrared wavelengths.

### Applications

- High stability, "non-doped" plastic marking
- Wafer & semiconductor marking
- WLC (Wafer-Level Package), memory cards, ICs marking
- Silicon scribing
- Glass epoxy marking
- Copper marking

## Technical data

		VLASE IR 10	VLASE IR 20	VLASE GR 10	VLASE UV 3
<b>Wavelength</b>	[nm]	1064	1064	532	355
<b>Nominal Power</b>	[W]	10	20	10	3
<b>Repetition Rate Range</b>	[KHz]	10 ÷ 100	20 ÷ 100	20 ÷ 100	20 ÷ 80
<b>Pulse Width</b>	[ns]	15@10KHz	8@20KHz	10@25KHz	8@25KHz
<b>Max Pulse Energy</b>	[mJ]	0.48@10kHz	0.55@20KHz	0.31@20KHz	0.12@25KHz
<b>Peak power</b>	[kW]	32@10KHz	65@20KHz	28@20KHz	14@25KHz
<b>Marking capabilities</b>		Standing, Rotary axis, On the fly (marking in motion)			
<b>Integration</b>		Up to 4 mechanical axis driving capabilities (stepper motor) Up to 10 digital inputs and 10 digital output fully programmable dedicated connectors Encoder and Photocell			
<b>Interface</b>		Ethernet, RS 232, USB			
<b>Optical Fiber</b>		Detachable – 3 meters standard- 5 meters OPZ			
<b>Aiming Beam</b>		Integrated			
<b>Power Supply</b>		100- 240 VAC 50/60Hz – 600 W max			
<b>Cooling System</b>		Air cooled			

# UNIQT<sup>TM</sup> & ULYXE SERIES

## UniQ<sup>TM</sup> - Compact , Powerful, integrated: unique!

UniQ laser marker is a revolutionary and innovative approach to fiber laser marking:

**For the first time on the market**, no external controller or power supply is needed, no fiber delivery constrains, no fiber length or bending radius limitations.

An advanced mechanical design and high-quality components provide an **IP54 degree of protection** for harsh environment and industrial application.

UniQ laser marker works seamless with Datalogic's Lighter Suite, providing a user-friendly, powerful interface and complete software tools, and is fully compatible with other DLA's laser control interface.

UniQ marker provided an extremely compact and flexible solution for manufacturing industries where the ease of use, dimensions and price/power ratio are the most important buying criteria.

Built in SLO (Safe Laser Off) system to quick and easy integration in EN13849-1 compliant installation, ease of maintenance and improved safety features keep overall operating and installation costs lower than any other laser marking system.



## Applications

- DPM ( Direct part marking ) on Plastic and metal materials in automotive, electronics and healthcare industries
- Laser Annealing on high precision metal components

**Ulyxe family** is the most compact and versatile Solid State Laser Marker on the market (only 42cm, 16,5").

Thanks to its advanced technology **the Ulyxe family provides the best price to performance ratio in the laser marking world.**

As a result of its cost-effectiveness and competitive positioning, the Ulyxe family is the first choice in marking solutions even when compared with traditional marking techniques. With its extreme compactness, this laser family represents the ideal laser marking solution both in standalone configurations as well as OEM applications.

The air cooled laser sources offer an ultra-compact design and includes the scanning head, digital control and monitoring functions. The outside cover on the units are equipped with a specifically designed high-tech case, available in different materials (polyurethane and metal) depending on different application requirements. The operator can easily interact and monitor important laser statuses and functions with a user-friendly LCD touch screen control display.

The Ulyxe compact laser family is available in two different control configurations (USB embedded controller and IMARk control kit) and in **two case styles, bicolors thermoplastic or stainless steel case.**



## USB EMBEDDED CONTROLLER

With an embedded DPS controller, the Ulyxe combines compact dimensions with user-friendly interface (LIGHTER Suite) installation and set-up. Laser marking has never been easier. This configuration is available for both polycarbonate or metal cases.

## Applications

- Plastic and metal marking in automotive, electronics and healthcare industries
- Label Marking
- DPM (Direct Part Marking)
- Tool Marking
- Marking on surgical tools/devices

## Technical data

		UNIQT	ULYXE
<b>Technology</b>		Fiber	Solid State
<b>Wavelength</b>	[nm]	1060-1070nm	1064nm
<b>Nominal power</b>	[W]	15W	6W
<b>Repetition Rate range</b>	[kHz]	15-100 kHz	15-200 kHz
<b>Pulse Width</b>	[ns]	120 ns	20-25 ns@20kHz
<b>Max Pulse Energy</b>	[mJ]	0.75mJ	300µJ@15 kHz
<b>Aiming &amp; Focus Finder Beam</b>		integrated	
<b>Connectivity</b>		USB, RS232, Ethernet, TCP-IP	USB
<b>Cooling System</b>		Air cooled	
<b>Dimensions</b>		Rack: 497,3 x 150 x 183,5 mm3    Weight:10,2 Kg	426x154x170 mm
<b>Power Supply</b>		100/240 VAC – 50/60 Hz – 200 W (MAX)	24VDC/13A
<b>IP protection level</b>		IP54	IP21



# AREX SERIES

The **AREX400 Series** is the latest release of Datalogic best-selling fiber laser markers dedicated to direct part marking in the Automotive, Electronics, and precision mechanics industry.

Because of its exceptionally small and robust scanner head machined from solid aluminum, the AREX 400 laser markers are unbeatable in tight space installations where a small footprint is mandatory and reliability is a must.

AREX 400 now incorporate Datalogic's patented 'Green Spot' technology, the award-winning programmable visual indicator for immediate good read feedback directly on the scanning area.

The totally new embedded controller is now offering improved computing performances, built-in SLO (Safety Laser Off), a cost effective native communication protocols (TCP/IP, Ethernet IP, and Profinet), and quiet operations down to 65 dB.

AREX400 Series includes 5 different fiber laser sources, 10W, 20W, 30W, 50W and 20W M.O.P.A. on one single unified platform.

AREX400 design and configuration dramatically simplifies and speeds up machine design and system integration.

AREX 400 family is the preferred solution for any application requiring reliable Direct Part Marking (DPM) in manufacturing industries, from automotive to precision mechanics and from industrial electronics to healthcare manufacturing.



## MOFA FIBER LASER TECHNOLOGY

M.O.P.A. (Master Oscillator Power Amplifier) fiber laser technology offers a higher level of parametric flexibility thanks to the capability to adapt laser pulse duration on a wider range of repetition frequency. The capability to adjust pulse width allows to minimize the material's heat affected zone (HAZ) and to avoid unwanted thermal effect induced in sensitive materials. High pulse-to-pulse stability ensure high contrast stability even on critical substrate.

## Applications

- High contrast DPM (Direct Part Marking) on plastic and metals in automotive, electronics and healthcare industries
- Laser Engraving on metal
- Annealing & color marking on metals components in aerospace precision mechanic industry
- Label Replacement
- High quality Branding and texturing on electronics devices

## Technical data

		AREX 10	AREX 20	AREX 30	AREX 50	AREX 20MW
<b>Wavelength</b>	[nm]	1060-1080				
<b>Laser source</b>		Pulsed Fiber Laser				M.O.P.A. Fiber Laser
<b>Nominal power</b>	[W]	10	20	30	50	>20
<b>Repetition rate</b>	[kHz]	20 ÷ 100	30 ÷ 100	50 ÷ 100	20 ÷ 500	Repetition rate
<b>Pulsewidth (Typ)</b>	[ns]	FIXED: 100				Adj: 4, 8, 12, 30, 50, 100, 200, 250
<b>Pulse energy (max)</b>	[mJ]	1,0				0,6
<b>Peak power (max)</b>	[kW]	10		10		12
<b>Fiber lenght</b>	[m]	3				
<b>Marking capabilities</b>		Standing, Rotary axis, On the fly (marking in motion)				
<b>Integration</b>		Up to 4 mechanical axis driving capabilities (stepper motor) Up to 10 digital inputs and 10 digital output fully programmable dedicated connectors Encoder and Photocell				
<b>Aiming &amp; Focus Finder Beam</b>		Integrated				
<b>Protection rating</b>		Head: IP64; Controller: IP31				
<b>Cooling</b>		Air cooled				
<b>Power Supply</b>		100/240 VAC – 50/60 Hz – 400 W (MAX)				

# EOX SERIES

**EOX** is the **CO2 Laser family for laser coding and marking** applications. The EOX family offers high quality permanent marking on a wide range of materials including cardboard, ceramic, wood, plastics and painted or anodized metal. Combining excellent laser beam quality and advanced control unit, the EOX family is suitable for accurate industrial traceability as well as high productivity coding applications.

CO2 laser family is available in 2 power levels, **10W and 30W**, with the same marking platform but with different mechanical configurations. 10W versions are offered in an **ALL-IN-ONE case** with very compact dimensions. 30W versions combine of a **compact marking head** with a control rack equipped with power supply and control unit.

Both 10W and 30W versions provide **axis control and an encoder port for Marking On the Fly (MOF)**, which is typically required for coding applications. Advanced MOF features offers complete synchronization between marking head and object movement even in accelerated or start-s top movement conditions. **MOF increases production lines throughput with linear speeds up to 75mt/min and 12.000 pcs/hour**. A CO2 marking system is very attractive for low cost of operation coding applications, due to no maintenance and no requirement for expensive consumables.

The EOX meets flexibility requirements with extended marking area up to 140x140mm (focal lens dependent). Reliable and safe, the EOX family provides a clean technology with short return of investment and minimal maintenance.



## Applications

- Coding and marking applications in food, pharmaceutical, and electronics industries
- Marking on organic materials
- Marking on cartons, papers, thermoplastic, painted and coated metals
- Coding and marking applications in food, pharmaceutical, and electronics industries

## Technical data

		EOX 10	EOX 30
<b>Wavelength</b>	[µm]	10,6	
<b>Nominal power</b>	[W]	10	30
<b>Aiming &amp; Focus Finder Beam</b>		Integrated	
<b>Cooling System</b>		Air cooled	
<b>Head dimensions</b>	[mm]	180x185x634	
<b>Rack dimensions</b>	[mm]	-	437x94x333
<b>Power Supply</b>		100/240 VAC - 50/60 Hz	



Rev. 11, 03/2019



9C300000

Product and Company names and logos referenced may be either trademarks or registered trademarks of their respective companies. We reserve the right to make modifications and improvements.

[www.datalogic.com](http://www.datalogic.com)